

# BILSTEIN Range

Shock Absorbers &  
Suspension Systems  
2014/2015

BILSTEIN®





# A warm welcome to BILSTEIN!















Now that you are holding this catalogue in your hands, it is only a small step to the wide variety of products from BILSTEIN. For roughly 60 years, BILSTEIN has stood for top quality and performance in suspension construction both at home and abroad, no matter whether in the field of original equipment, series replacement, tuning or motorsport. We stock our high-quality products – all of which have been tested in elaborate road tests – in OE quality for all vehicle classes and specially tailored to the intended purpose of each suspension. Numerous national and international motorsport successes with

BILSTEIN suspensions and a number of “Best Brand” awards, with which you demonstrate your trust in us, are evidence and incentive at the same time. Trust that the big automobile brands also show us. Together with our partners, we develop and produce for series production and the aftermarket. Get to know the versatility of BILSTEIN. Convince yourself and experience the unique BILSTEIN driving feeling!

ThyssenKrupp BILSTEIN GmbH  
Division Aftermarket









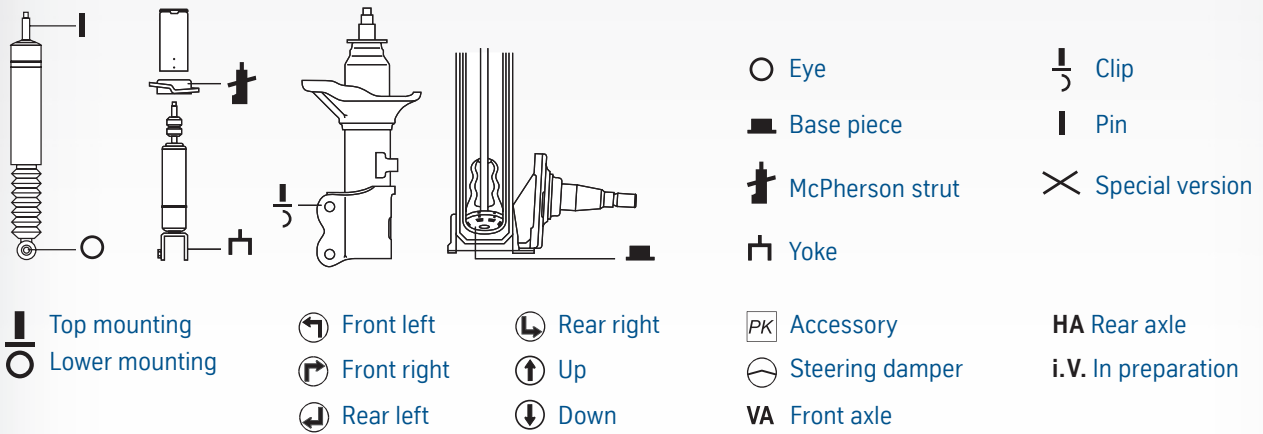























# BILSTEIN-Shock-Finder: All products at a glance.

Vehicle manufacturer	Vehicle type and model	Front axle	Rear axle		
					
<b>PORSCHE</b>					
<b>PORSCHE BOXSTER (987)</b>					
B6	2.7, 2.9, S 3.2, S 3.4 11/04 - 176 -228 kW	35-122180 	35-122197 	ohne PASM	
B6 DTC	2.7, 2.9, S 3.2, S 3.4 11/04 - 176 -228 kW	31-122139 	31-122146   	mit PASM 	
B8	2.7, 2.9, S 3.2, S 3.4 11/04 - 176 -228 kW	35-122203 	35-122210    	ohne PASM	
Product range	Year	Engine	Part number	Type of mounting	Note

## Legend



# Product overview

	B1	B2	B3	B4
 BILSTEIN-Original-Equipment				
 BILSTEIN gas pressure technology				
 BILSTEIN mono-tube/Upside-Down technology				
 Twin-tube technology				
 BILSTEIN round threads				
 BILSTEIN-Triple-C-Technology®				
 Threaded body adjustable range				
 Air suspension				
 Lowering				
 Body lifting				
 Goes with lowering springs				
 Goes with body lift kits				
 1-way adjustment system				
 2-way adjustment system				
 Road-tested by BILSTEIN				
 DampMatic®				
 DampTronic®				
 ridecontrol®				
 iRC®				

Variations possible, depending on the version and/or vehicle model

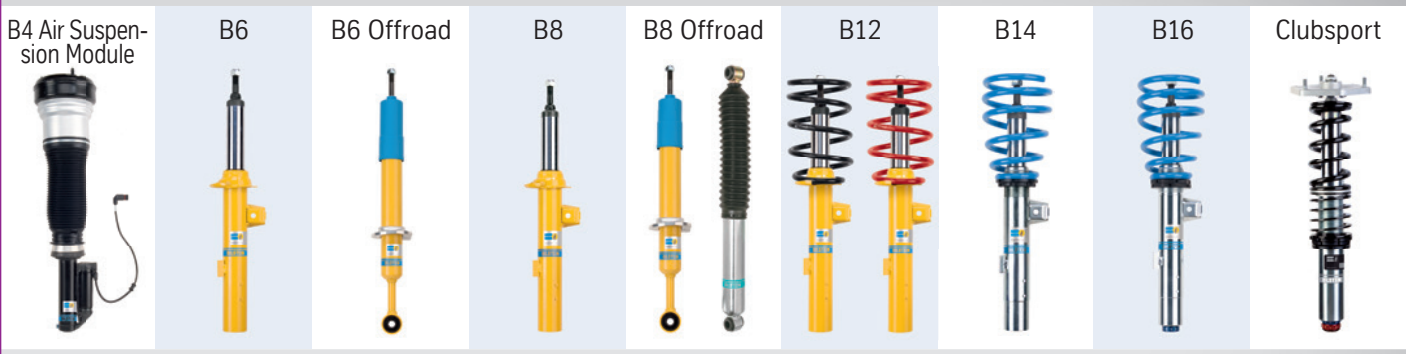



















# Contents



Catalogue range _____	1-878	Obsolete range 2014 _____	917
New order number –		Protection kits _____	921
Old order number _____	879	Motorsport _____	925
New in the range 2014 _____	914	Notes and explanations _____	935

## Catalogue range

Acura _____	1	De Lorean _____	223	Landwind (JMC) _____	364	Puch _____	600
Alfa Romeo _____	1	Dodge _____	223	Lexus _____	364	Renault _____	601
Alpina _____	13	Fiat _____	226	Lincoln _____	366	Rover _____	625
Artega _____	15	Fiat (Nanjing) _____	257	Lotus _____	366	Renault Samsung	626
Audi _____	15	Fiat (GAC) _____	257	Mahindra Renault	366	Saab _____	626
Audi-FAW _____	91	Ford _____	257	Maruti _____	367	Seat _____	631
Austin _____	94	Ford (Changan) _____	302	Maruti Suzuki _____	367	Skoda _____	655
Austin-Healey _____	95	Ford USA _____	303	Mazda _____	367	Skoda (SVW) _____	674
Autobianchi _____	95	FSO _____	311	Mazda (Changan) _____	382	Smart _____	675
Auto Union _____	95	GAZ _____	312	Mercedes-Benz _____	383	Ssangyong _____	677
BAW _____	95	Geo _____	312	Mercedes-Benz		Subaru _____	678
Bentley _____	95	GMC _____	313	(BBDC) _____	450	Suzuki _____	682
BMW _____	95	Holden _____	315	Mercedes-Benz		Suzuki (Changan) _____	687
BMW (Brilliance) _____	160	Honda _____	323	(FJDA) _____	452	Suzuki (Changhe) _____	687
Buick _____	163	Hummer _____	336	Mercury _____	452	Tofas _____	688
Buick (SGM) _____	165	Hyundai _____	337	MG _____	452	Toyota _____	688
Cadillac _____	168	Infiniti _____	342	Mini _____	453	Toyota (GAC) _____	709
Callaway _____	168	Innocenti _____	342	Mitsubishi _____	459	Trabant _____	709
Caterham _____	169	Irmscher _____	342	Moskvich _____	471	Vauxhall _____	710
Chevrolet _____	169	Isuzu _____	342	Nissan _____	471	Volvo _____	756
Chevrolet (SGM) _____	191	Jaguar _____	344	Nissan (Dongfeng)	489	Volvo (Changan) _____	772
Chrysler _____	192	Jeep _____	347	NSU _____	489	VW _____	773
Chrysler (BBDC) _____	193	Kia _____	351	Opel _____	490	VW-FAW _____	870
Citroën _____	193	Kia (DYK) _____	354	Peugeot _____	556	VW (SVW) _____	876
Dacia _____	215	Lada _____	355	Plymouth _____	584	Wartburg _____	877
Daewoo _____	218	Lamborghini _____	357	Pontiac _____	585	Zastava _____	877
Daihatsu _____	221	Lancia _____	357	Porsche _____	585		
Daimler _____	222	Land Rover _____	361	Proton _____	600		



				
<b>MERCEDES-BENZ</b>				
<b>MERCEDES-BENZ E-CLASS Estate (S124)</b>				
B6 Sport	300 TD T, E 200 T, E 220 T, E 250 T D, E 250 Turbo D, E 280 T, E 300 T D, E 300 T Turbo-D, E 320 T 06/92 - 06/96 83 -162 kW	22-100436 †		with standard chassis
B8	300 TD T, E 200 T, E 220 T, E 250 T D, E 250 Turbo D, E 280 T, E 300 T D, E 300 T Turbo-D, E 300 TE-24 AMG, E 320 T, E 36 T AMG 06/92 - 06/96 83 -200 kW	22-003652 †		with sports suspension
<b>MERCEDES-BENZ E-CLASS Coupe (C124)</b>				
B1	E 200, E 220, E 320 06/93 - 06/97 100 -162 kW	12-116928		VA: without ball bearing
B3	E 200, E 220 06/93 - 06/97 100 -110 kW	36-225880	36-129416	with standard chassis
B3	E 200, E 220 06/93 - 06/97 100 -110 kW	36-225996	36-226009	with standard chassis; Heavy Duty Version .
B3	E 320 06/93 - 06/97 162 kW	36-225996	36-129416	with standard chassis
B3	E 320 06/93 - 06/97 162 kW		36-226009	with standard chassis; Heavy Duty Version .
B4	E 200, E 220, E 320 06/93 - 06/97 100 -162 kW	22-001900 † 11-101406  18-140651 	24-016681 	with standard chassis
B4	E 200, E 220, E 320 06/93 - 06/97 100 -162 kW	22-003614 † 11-101406  18-140651 	24-013857 	mark: Heavy Duty
B4	E 200, E 220, E 320, E 36 AMG 06/93 - 06/97 100 -200 kW	22-040534 † 18-140651 	24-016124 	mark: Sportline
B6 Sport	E 200, E 220, E 320 06/93 - 06/97 100 -162 kW	22-100436 †	24-100441 	with standard chassis
B8	E 200, E 220, E 320, E 36 AMG 06/93 - 06/97 100 -200 kW	22-003652 †	24-014700 	with sports suspension
<b>MERCEDES-BENZ E-CLASS Convertible (A124)</b>				
B1	E 200, E 220, E 320 06/93 - 03/98 100 -162 kW	12-116928		VA: without ball bearing
B3	E 200, E 220, E 320, E 36 AMG 06/93 - 03/98 100 -200 kW	36-134519		
B4	E 200, E 220, E 320 06/93 - 12/95 100 -162 kW	22-040534 † 11-101406  18-140651 	24-016124 	
B6 Sport	E 200, E 220, E 320 06/93 - 12/95 100 -162 kW	22-100436 †	24-100441 	with standard chassis
B8	E 200, E 220, E 320 06/93 - 12/95 100 -162 kW	22-003652 †	24-014700 	with sports suspension
<b>MERCEDES-BENZ E-CLASS (W210)</b>				
B3	E 200, E 200 D, E 200 Kompressor, E 220 D, E 230, E 240, E 280, E 320 06/95 - 03/02 55 -165 kW	36-129584	36-129676	with sports suspension; mark: Avantgarde; without ride height adjustment



				
<b>MERCEDES-BENZ</b>				
<b>MERCEDES-BENZ E-CLASS (W210)</b>				
B3	<b>E 200, E 200 Kompressor</b> 06/95 - 03/02 100 -137 kW	<b>36-129591</b>		with sports suspension; Heavy Duty Version .; mark: Avantgarde
B3	<b>E 200</b> 06/95 - 06/99 100 kW	<b>36-129485</b>	<b>36-225927</b>	-> CH.Nr.: A394035; with standard chassis; mark: Classic; mark: Elegance; without ride height adjustment
B3	<b>E 200</b> CH-Nr. - 06/99 100 kW	<i>36-129607</i>	<b>36-225927</b>	CH.Nr.: A394036-> A962231; with standard chassis; mark: Classic; mark: Elegance; without ride height adjustment
B3	<b>E 200</b> 06/95 - 06/99 100 kW	<b>36-233779</b>	<b>36-129669</b>	-> CH.Nr.: A962231; with standard chassis; Heavy Duty Version .; mark: Classic; mark: Elegance; without ride height adjustment
B3	<b>E 200, E 240, E 280</b> 07/99 - 03/02 100 -150 kW	<b>36-233779</b>	<b>36-225927</b>	CH.Nr.: A962232 ->; with standard chassis; mark: Classic; mark: Elegance; without ride height adjustment
B3	<b>E 200, E 240, E 280</b> 07/99 - 03/02 100 -150 kW	<b>36-129621</b>	<b>36-129669</b>	CH.Nr.: A962232 ->; with standard chassis; Heavy Duty Version .; mark: Classic; mark: Elegance; without ride height adjustment
B3	<b>E 200, E 200 CDI, E 200 D, E 200 Kompressor, E 220 CDI, E 220 D, E 230, E 240, E 250 D, E 250 Turbo-D, E 280, E 290 Turbo-D, E 300 D, E 300 Turbo-D, E 320, E 320 CDI</b> 06/95 - 03/02 65 -162 kW		36-133673	with standard chassis; mark: Classic; mark: Elegance; with ride height adjustment
B3	<b>E 230, E 240</b> 06/95 - 06/99 110 -125 kW	<b>36-129485</b>	<b>36-225927</b>	-> CH.Nr.: A394035; with standard chassis; mark: Classic; mark: Elegance; without ride height adjustment; manual transmission
B3	<b>E 230, E 240</b> CH-Nr. - 06/99 110 -125 kW	<i>36-129607</i>	<b>36-225927</b>	CH.Nr.: A394036-> A962231; with standard chassis; mark: Classic; mark: Elegance; without ride height adjustment; manual transmission
B3	<b>E 230, E 240</b> 06/95 - 06/99 110 -125 kW	<b>36-233779</b>	<b>36-225927</b>	-> CH.Nr.: A962231; with standard chassis; mark: Classic; mark: Elegance; without ride height adjustment; automatic transmission
B3	<b>E 230, E 240, E 300 D</b> 06/95 - 06/99 100 -125 kW	<b>36-134526</b>	<b>36-129669</b>	-> CH.Nr.: A394035; with standard chassis; Heavy Duty Version .; mark: Classic; mark: Elegance; without ride height adjustment
B3	<b>E 230, E 240</b> CH-Nr. - 06/99 110 -125 kW	<b>36-129621</b>	<b>36-129669</b>	CH.Nr.: A394036-> A962231; with standard chassis; Heavy Duty Version .; mark: Classic; mark: Elegance; without ride height adjustment
B3	<b>E 320</b> 06/95 - 06/97 162 kW	<b>36-233779</b>	<b>36-225927</b>	with standard chassis; mark: Classic; mark: Elegance; without ride height adjustment
B3	<b>E 320</b> 06/95 - 06/97 162 kW	<b>36-134526</b>	<b>36-129669</b>	with standard chassis; Heavy Duty Version .; mark: Classic; mark: Elegance; without ride height adjustment
B3	<b>E 320, E 430</b> CH-Nr. - 03/02 165 -205 kW	<b>36-233779</b>	<b>36-129669</b>	CH.Nr.: A394036 ->; with standard chassis; mark: Classic; mark: Elegance
B3	<b>E 320, E 430</b> CH-Nr. - 03/02 165 -205 kW	<b>36-129621</b>	<b>36-129683</b>	CH.Nr.: A394036 ->; with standard chassis; Heavy Duty Version .; mark: Classic; mark: Elegance
B3	<b>E 420, E 430, E 430 4-matic</b> 01/96 - 03/02 205 kW	<b>36-129591</b>	<b>36-226030</b>	with standard chassis; mark: Avantgarde
B3	<b>E 420, E 430</b> 01/96 - 06/99 205 kW	<b>36-134526</b>	<b>36-129669</b>	-> CH.Nr.: A394035; with standard chassis; mark: Classic; mark: Elegance
B3	<b>E 420, E 430</b> 01/96 - 06/99 205 kW		<b>36-129683</b>	-> CH.Nr.: A394035; with standard chassis; Heavy Duty Version .; mark: Classic; mark: Elegance
B3	<b>E 430 4-matic</b> 05/99 - 03/02 205 kW	<b>36-129621</b>	<b>36-129669</b>	with standard chassis; mark: Classic; mark: Elegance
B3	<b>E 200 D, E 220 D, E 230, E 240, E 280, E 320</b> 06/95 - 03/02 55 -165 kW	<b>36-129591</b>	<b>36-226030</b>	with sports suspension; Heavy Duty Version .; mark: Avantgarde; without ride height adjustment





## MERCEDES-BENZ



### MERCEDES-BENZ E-CLASS (W210)



B3	<b>E 200 D, E 200 Kompressor, E 220 D, E 250 D, E 250 Turbo-D, E 280, E 290 Turbo-D</b> 06/95 - 06/99 55 -150 kW	<b>36-233779</b>	<b>36-225927</b>	-> CH.Nr.: A962231; with standard chassis; mark: Classic; mark: Elegance; without ride height adjustment
B3	<b>E 200 D, E 200 Kompressor, E 220 D, E 250 D, E 250 Turbo-D, E 280, E 290 Turbo-D</b> 06/95 - 06/99 55 -142 kW	<b>36-134526</b>	<b>36-129669</b>	-> CH.Nr.: A394035; with standard chassis; Heavy Duty Version .; mark: Classic; mark: Elegance; without ride height adjustment
B3	<b>E 200 D, E 200 Kompressor, E 220 D, E 250 D, E 250 Turbo-D, E 280, E 290 Turbo-D</b> CH-Nr. - 06/99 55 -150 kW	<b>36-129621</b>	<b>36-129669</b>	CH.Nr.: A394036-> A962231; with standard chassis; Heavy Duty Version .; mark: Classic; mark: Elegance; without ride height adjustment
B3	<b>E 200 CDI, E 220 CDI, E 220 D, E 250 D, E 250 Turbo-D, E 290 Turbo-D, E 300 D</b> 06/95 - 03/02 70 -110 kW	<b>36-129584</b>	<b>36-129676</b>	with sports suspension; mark: Avantgarde; without ride height adjustment; manual transmission
B3	<b>E 200 CDI, E 220 CDI, E 220 D, E 250 D, E 250 Turbo-D, E 290 Turbo-D, E 300 D</b> 06/95 - 03/02 70 -110 kW	<b>36-129591</b>	<b>36-226030</b>	with standard chassis; Heavy Duty Version .; mark: Avantgarde; without ride height adjustment
B3	<b>E 200 CDI, E 220 CDI, E 300 D, E 300 Turbo-D</b> 12/96 - 06/99 75 -130 kW	<b>36-134526</b>	<b>36-225927</b>	-> CH.Nr.: A394035; with standard chassis; mark: Classic; mark: Elegance; without ride height adjustment
B3	<b>E 200 CDI, E 220 CDI, E 270 CDI, E 300 D, E 300 Turbo-D, E 320 CDI</b> 12/96 - 03/02 75 -145 kW		<b>36-129669</b>	with standard chassis; Heavy Duty Version .; mark: Classic; mark: Elegance; without ride height adjustment
B3	<b>E 200 CDI, E 200 D, E 200 Kompressor, E 220 CDI</b> CH-Nr. - 03/02 65 -137 kW	<b>36-233779</b>	<b>36-225927</b>	CH.Nr.: A394036 ->; with standard chassis; mark: Classic; mark: Elegance; without ride height adjustment; manual transmission
B3	<b>E 200 CDI, E 200 D, E 200 Kompressor, E 220 CDI</b> CH-Nr. - 03/02 65 -137 kW	<b>36-129621</b>	<b>36-225927</b>	CH.Nr.: A394036 ->; with standard chassis; mark: Classic; mark: Elegance; without ride height adjustment; automatic transmission
B3	<b>E 200 CDI, E 200 D, E 200 Kompressor, E 220 CDI</b> CH-Nr. - 03/02 65 -137 kW	<b>36-129621</b>	<b>36-129669</b>	CH.Nr.: A394036 ->; with standard chassis; Heavy Duty Version .; mark: Classic; mark: Elegance; without ride height adjustment
B3	<b>E 220 CDI, E 270 CDI, E 320 CDI</b> 07/99 - 03/02 92 -145 kW	<b>36-129621</b>	<b>36-225927</b>	CH.Nr.: A394036 ->; with standard chassis; mark: Classic; mark: Elegance; without ride height adjustment
B3	<b>E 270 CDI, E 300 Turbo-D, E 320 CDI</b> 12/96 - 03/02 125 -145 kW	<b>36-129591</b>	<b>36-129676</b>	with sports suspension; Heavy Duty Version .; mark: Avantgarde; without ride height adjustment
B3	<b>E 270 CDI, E 300 Turbo-D, E 320 CDI</b> 12/96 - 03/02 125 -145 kW		<b>36-226030</b>	with sports suspension; Heavy Duty Version .; mark: Avantgarde; with ride height adjustment
B4	<b>E 200, E 200 D, E 200 Kompressor, E 220 D, E 240, E 280, E 320, E 430</b> 06/95 - 06/99 55 -205 kW	<b>24-108256</b> $\frac{1}{\circ}$	<b>24-108263</b> $\frac{1}{\circ}$	-> CH.Nr.: A394035; with standard chassis; without ADS; without ride height adjustment
B4	<b>E 200, E 200 D, E 200 Kompressor, E 220 D, E 240, E 280, E 320, E 430</b> 06/95 - 06/99 55 -205 kW	<b>24-021548</b> $\frac{1}{\circ}$	<b>24-021555</b> $\frac{1}{\circ}$	-> CH.Nr.: A394035; without ADS; mark: Heavy Duty; without ride height adjustment
B4	<b>E 200, E 200 D, E 200 Kompressor, E 220 D, E 240, E 280, E 320, E 430</b> 06/95 - 06/99 55 -205 kW	<b>24-100540</b> $\frac{1}{\circ}$	<b>24-100557</b> $\frac{1}{\circ}$	-> CH.Nr.: A394035; with sports suspension; without ADS; mark: Avantgarde; without ride height adjustment
B4	<b>E 200, E 200 D, E 200 Kompressor, E 220 D, E 240, E 280, E 320, E 430</b> 07/99 - 03/02 55 -205 kW	<b>24-100540</b> $\frac{1}{\circ}$	<b>24-100564</b> $\frac{1}{\circ}$	CH.Nr.: A394036 ->; with standard chassis; without ADS; without ride height adjustment
B4	<b>E 200, E 200 D, E 200 Kompressor, E 220 D, E 240, E 280, E 320, E 430</b> 07/99 - 03/02 55 -205 kW	<b>24-100571</b> $\frac{1}{\circ}$	<b>24-100588</b> $\frac{1}{\circ}$	CH.Nr.: A394036 ->; with sports suspension; without ADS; mark: Avantgarde; without ride height adjustment
B4	<b>E 280 4-matic, E 320 4-matic, E 430 4-matic</b> 12/96 - 03/02 150 -205 kW	<b>24-060905</b> $\frac{1}{\text{H}}$	<b>24-108263</b> $\frac{1}{\circ}$	with standard chassis; without ride height adjustment

			
<b>MERCEDES-BENZ</b>			
<b>MERCEDES-BENZ E-CLASS (W210)</b>			
B4	E 200 CDI, E 220 CDI, E 220 D, E 230, E 250 D, E 250 Turbo-D, E 280, E 290 Turbo-D, E 300 D, E 300 Turbo-D, E 320, E 420 01/96 - 03/02 70 -205 kW	24-108256 $\frac{1}{\circ}$	24-108263 $\frac{1}{\circ}$ with standard chassis; without ride height adjustment
B4	E 200 CDI, E 220 CDI, E 230, E 250 D, E 250 Turbo-D, E 280, E 290 Turbo-D, E 300 D, E 300 Turbo-D, E 320, E 420 01/96 - 03/02 75 -205 kW	24-021548 $\frac{1}{\circ}$	24-021555 $\frac{1}{\circ}$ mark: Heavy Duty
B4	E 200 CDI, E 220 CDI, E 220 D, E 230, E 250 D, E 250 Turbo-D, E 280, E 290 Turbo-D, E 300 D, E 300 Turbo-D, E 320, E 420 01/96 - 03/02 70 -205 kW	24-100540 $\frac{1}{\circ}$	24-100557 $\frac{1}{\circ}$ with sports suspension; mark: Avantgarde; without ride height adjustment
B4	E 200 CDI, E 200 Kompressor, E 220 CDI, E 240, E 270 CDI, E 320 CDI 07/99 - 03/02 85 -145 kW	24-100540 $\frac{1}{\circ}$	24-100564 $\frac{1}{\circ}$ with standard chassis; without ride height adjustment
B4	E 200 CDI, E 200 Kompressor, E 220 CDI, E 240, E 270 CDI, E 320 CDI 07/99 - 03/02 85 -145 kW	24-100571 $\frac{1}{\circ}$	24-100588 $\frac{1}{\circ}$ with sports suspension; mark: Avantgarde; without ride height adjustment
B4	E 220 D 06/95 - 06/99 70 kW	24-021548 $\frac{1}{\circ}$	24-021555 $\frac{1}{\circ}$ -> CH.Nr.: A394035; mark: Heavy Duty; without ride height adjustment
B6 Sport	E 200, E 200 CDI, E 200 D, E 200 Kompressor, E 220 CDI, E 220 D, E 240, E 250 D, E 250 Turbo-D, E 280, E 290 Turbo-D, E 300 Turbo-D, E 320, E 430 06/95 - 06/99 55 -205 kW	24-100458 $\frac{1}{\circ}$	24-100465 $\frac{1}{\circ}$ -> CH.Nr.: A394035; without ADS; without ride height adjustment
B6 Sport	E 200, E 200 CDI, E 200 D, E 200 Kompressor, E 220 CDI, E 220 D, E 240, E 270 CDI, E 280, E 320, E 320 CDI, E 430 07/99 - 03/02 55 -205 kW	24-021562 $\frac{1}{\circ}$	24-062039 $\frac{1}{\circ}$ CH.Nr.: A394036 ->; without ADS; without ride height adjustment
B6 Sport	E 230, E 280, E 300 D, E 320, E 420 06/95 - 06/97 100 -205 kW	24-100458 $\frac{1}{\circ}$	24-100465 $\frac{1}{\circ}$ without ride height adjustment
B8	E 200, E 200 CDI, E 200 D, E 200 Kompressor, E 220 CDI, E 220 D, E 240, E 250 D, E 250 Turbo-D, E 280, E 290 Turbo-D, E 300 Turbo-D, E 320, E 430, E 50 AMG 06/95 - 06/99 55 -255 kW	24-021562 $\frac{1}{\circ}$	24-021579 $\frac{1}{\circ}$ -> CH.Nr.: A394035; without ADS; without ride height adjustment
B8	E 200, E 200 CDI, E 200 D, E 200 Kompressor, E 220 CDI, E 220 D, E 240, E 270 CDI, E 280, E 320, E 320 CDI, E 430, E 55 AMG 07/99 - 03/02 55 -260 kW	24-062046 $\frac{1}{\circ}$	24-062053 $\frac{1}{\circ}$ CH.Nr.: A394036 ->; without ADS; without ride height adjustment
B8	E 230, E 280, E 300 D, E 320, E 420 06/95 - 06/97 100 -205 kW		24-021579 $\frac{1}{\circ}$ without ride height adjustment
B12 PK	E 200, E 200 CDI, E 200 D, E 200 Kompressor, E 220 CDI, E 220 D, E 230, E 250 D, E 250 Turbo-D, E 290 Turbo-D 06/95 - 06/99 55 -137 kW	46-190413	-> CH.Nr.: A394035; spring pads must be observed; without ADS; without ride height adjustment; Conditions see certificates VA: lowering (expertise): 35 mm; axle load to: 1095 kg HA: lowering (expertise): 30 mm; axle load to: 1165 kg
B12 PK	E 200, E 200 CDI, E 200 D, E 200 Kompressor, E 220 D, E 270 CDI 07/99 - 03/02 55 -137 kW	46-190420	CH.Nr.: A394036 ->; spring pads must be observed; without ADS; without ride height adjustment; Conditions see certificates VA: lowering (expertise): 35 mm; axle load to: 1095 kg HA: lowering (expertise): 30 mm; axle load to: 1165 kg



M





			
<b>MERCEDES-BENZ</b>			
<b>MERCEDES-BENZ E-CLASS (W210)</b>			
B12 PK	<b>E 240, E 280, E 320, E 430</b> 06/95 - 06/99      125 -205 kW	<b>46-190437</b>	-> CH.Nr.: A394035; spring pads must be observed; without ADS; without ride height adjustment; Conditions see certificates VA: lowering (expertise): 35 mm; axle load to: 1095 kg HA: lowering (expertise): 30 mm; axle load to: 1165 kg
B12 PK	<b>E 240, E 280, E 320, E 430</b> 07/99 - 03/02      125 -205 kW	<b>46-190444</b>	CH.Nr.: A394036 ->; spring pads must be observed; without ADS; without ride height adjustment; Conditions see certificates VA: lowering (expertise): 35 mm; axle load to: 1095 kg HA: lowering (expertise): 30 mm; axle load to: 1165 kg
B12 PK	<b>E 220 CDI</b> 07/99 - 03/02      105 kW	<b>46-190420</b>	CH.Nr.: A394035 ->; spring pads must be observed; without ADS; without ride height adjustment; Conditions see certificates VA: lowering (expertise): 35 mm; axle load to: 1095 kg HA: lowering (expertise): 30 mm; axle load to: 1165 kg

<b>MERCEDES-BENZ E-CLASS Estate (S210)</b>			
B3	<b>E 200 T, E 200 T Kompressor, E 220 T CDI, E 230 T, E 240 T, E 250 T D, E 250 T Turbo-D, E 270 T CDI, E 280 T, E 290 T Turbo-D, E 300 T Turbo-D, E 320 T, E 320 T CDI, E 420 T, E 430 T</b> 06/96 - 03/03      83 -205 kW	<b>36-129584</b>	<b>36-171989</b> with sports suspension; mark: Avantgarde
B3	<b>E 200 T, E 200 T Kompressor, E 220 T CDI, E 230 T, E 240 T, E 250 T D, E 250 T Turbo-D, E 270 T CDI, E 280 T, E 290 T Turbo-D, E 300 T Turbo-D, E 320 T, E 320 T CDI, E 420 T, E 430 T</b> 06/96 - 03/03      83 -205 kW	<b>36-129591</b>	<b>36-129676</b> with sports suspension; Heavy Duty Version .; mark: Avantgarde
B3	<b>E 200 T, E 230 T</b> 06/96 - CH-Nr.      100 -110 kW	<b>36-129485</b>	<b>36-198375</b> -> CH.Nr.: A 394035; with standard chassis; mark: Classic; mark: Elegance
B3	<b>E 200 T, E 230 T</b> 06/96 - CH-Nr.      100 -110 kW	<b>36-233779</b>	-> CH.Nr.: A 394035; with standard chassis; Heavy Duty Version .; mark: Classic; mark: Elegance
B3	<b>E 200 T, E 200 T Kompressor, E 220 T CDI, E 240 T, E 250 T D, E 320 T</b> 06/99 - 03/03      83 -165 kW	<b>36-233779</b>	<b>36-198375</b> CH.Nr.: A 962232 ->; with standard chassis; mark: Classic; mark: Elegance
B3	<b>E 200 T, E 200 T Kompressor, E 220 T CDI, E 240 T, E 250 T D, E 320 T</b> 06/99 - 03/03      83 -165 kW	<b>36-129621</b>	CH.Nr.: A 962232 ->; with standard chassis; Heavy Duty Version .; mark: Classic; mark: Elegance
B3	<b>E 200 T Kompressor, E 320 T</b> 12/96 - 05/99      137 -165 kW	<b>36-233779</b>	<b>36-198375</b> -> CH.Nr.: A 962231; with standard chassis; mark: Classic; mark: Elegance
B3	<b>E 200 T Kompressor, E 320 T</b> 12/96 - 05/99      137 -165 kW	<b>36-129621</b>	-> CH.Nr.: A 962231; with standard chassis; Heavy Duty Version .; mark: Classic; mark: Elegance
B3	<b>E 250 T D, E 290 T Turbo-D, E 420 T</b> 06/96 - CH-Nr.      83 -205 kW	<b>36-134526</b>	<b>36-198375</b> -> CH.Nr.: A 394035; with standard chassis; mark: Classic; mark: Elegance
B3	<b>E 250 T Turbo-D, E 270 T CDI, E 280 T, E 300 T Turbo-D, E 320 T CDI, E 430 T</b> 12/96 - 03/03      110 -205 kW	<b>36-129621</b>	<b>36-198375</b> with standard chassis; mark: Classic; mark: Elegance
B3	<b>E 290 T Turbo-D</b> CH-Nr. - 06/99      95 kW	<b>36-233779</b>	<b>36-198375</b> CH.Nr.: A 394036 ->; with standard chassis; mark: Classic; mark: Elegance
B4	<b>E 200 T, E 200 T Kompressor, E 220 T CDI, E 230 T, E 240 T, E 250 T D, E 250 T Turbo-D, E 280 T, E 290 T Turbo-D, E 300 T Turbo-D, E 320 T, E 420 T, E 430 T</b> 06/96 - 07/99      83 -205 kW	<b>24-108256</b> 	-> CH.Nr.: A394035; with standard chassis; without ADS
B4	<b>E 200 T, E 200 T Kompressor, E 220 T CDI, E 230 T, E 240 T, E 250 T D, E 250 T Turbo-D, E 280 T, E 290 T Turbo-D, E 300 T Turbo-D, E 320 T, E 420 T, E 430 T</b> 06/96 - 07/99      83 -205 kW	<b>24-100540</b> 	-> CH.Nr.: A394035; with sports suspension; without ADS; mark: Avantgarde



			
<b>MERCEDES-BENZ</b>			
<b>MERCEDES-BENZ E-CLASS Estate (S210)</b>			
B4	<b>E 200 T, E 200 T Kompressor, E 240 T, E 280 T, E 320 T, E 430 T</b> 07/99 - 03/03 100 -205 kW	<b>24-100540</b> $\frac{1}{\circ}$	with standard chassis; without ADS
B4	<b>E 200 T, E 200 T Kompressor, E 240 T, E 280 T, E 320 T, E 430 T</b> 07/99 - 03/03 100 -205 kW	<b>24-100571</b> $\frac{1}{\circ}$	with sports suspension; without ADS; mark: Avantgarde
B4	<b>E 200 T Kompressor, E 220 T CDI, E 240 T, E 270 T CDI, E 320 T CDI</b> 07/99 - 03/03 105 -145 kW	<b>24-100540</b> $\frac{1}{\circ}$	with standard chassis
B4	<b>E 200 T Kompressor, E 220 T CDI, E 240 T, E 270 T CDI, E 320 T CDI</b> 07/99 - 03/03 105 -145 kW	<b>24-100571</b> $\frac{1}{\circ}$	with sports suspension; mark: Avantgarde
B4	<b>E 280 T 4-matic, E 320 T 4-matic, E 430 T 4-matic</b> 12/96 - 03/03 150 -205 kW	<b>24-060905</b> $\frac{1}{\text{H}}$	with standard chassis; without ADS

<b>MERCEDES-BENZ E-CLASS (W211)</b>			
B1	<b>E 200 CDI, E 200 CGI, E 200 Kompressor, E 200 NGT, E 220 CDI, E 230, E 240, E 270 CDI, E 280, E 320, E 320 CDI, E 350, E 350 CGI, E 400 CDI, E 500</b> 03/02 - 12/08 75 -225 kW	<b>12-117864</b>	VA: without ball bearing
B3	<b>E 200 NGT</b> 03/04 - 12/08 120 kW	<b>36-226153</b>	<b>36-154142</b> with standard chassis
B3	<b>E 200 NGT, E 280, E 280 CDI, E 320 CDI</b> 11/02 - 12/08 120 -170 kW		<b>36-227211</b> with standard chassis; Heavy Duty Version .
B3	<b>E 200 NGT, E 280, E 280 CDI, E 320 CDI</b> 11/02 - 12/08 120 -170 kW	<b>37-163761</b>	<b>36-163731</b> with sports suspension; mark: Avantgarde
B3	<b>E 200 NGT, E 280, E 280 CDI, E 320 CDI</b> 11/02 - 12/08 120 -170 kW		<b>36-227211</b> with sports suspension; Heavy Duty Version .; mark: Avantgarde
B3	<b>E 280, E 280 CDI, E 320 CDI</b> 11/02 - 12/08 130 -170 kW	<b>36-226153</b>	<b>36-154142</b> with standard chassis
B3	<b>E 320</b> 03/02 - 12/08 165 kW	<b>37-154110</b>	<b>36-154135</b> with standard chassis
B3	<b>E 320</b> 03/02 - 12/08 165 kW	<b>37-163747</b>	<b>36-154159</b> with sports suspension; mark: Avantgarde
B3	<b>E 200 CDI, E 200 Kompressor, E 220 CDI, E 230, E 240</b> 03/02 - 12/08 75 -150 kW	<b>36-226146</b>	<b>36-154135</b> with standard chassis
B3	<b>E 200 CDI, E 200 Kompressor, E 220 CDI, E 230, E 240, E 320</b> 03/02 - 12/08 75 -165 kW	<b>36-226153</b>	<b>36-154142</b> with standard chassis; Heavy Duty Version .
B3	<b>E 200 CDI, E 200 Kompressor, E 220 CDI, E 230, E 240</b> 03/02 - 12/08 75 -150 kW	<b>37-163754</b>	<b>36-154159</b> with sports suspension; mark: Avantgarde
B3	<b>E 200 CDI, E 200 Kompressor, E 220 CDI, E 230, E 240, E 270 CDI, E 320</b> 03/02 - 12/08 75 -165 kW	<b>36-226153</b>	<b>36-154142</b> with sports suspension; Heavy Duty Version .; mark: Avantgarde
B3	<b>E 270 CDI</b> 03/02 - 12/08 130 kW	<b>37-154110</b>	<b>36-154142</b> with standard chassis
B3	<b>E 270 CDI</b> 03/02 - 12/08 130 kW	<b>36-226153</b>	<b>36-227211</b> with standard chassis; Heavy Duty Version .
B3	<b>E 270 CDI</b> 03/02 - 12/08 130 kW	<b>37-163747</b>	<b>36-163731</b> with sports suspension; mark: Avantgarde

				
<b>MERCEDES-BENZ</b>				
<b>MERCEDES-BENZ E-CLASS (W211)</b>				
B4	E 200 CDI, E 200 CGI, E 200 Kompressor, E 200 NGT, E 220 CDI, E 230, E 240, E 270 CDI, E 280, E 280 CDI, E 300 BLUETEC, E 320, E 320 CDI, E 350, E 350 CGI, E 400 CDI, E 420 CDI 03/02 - 12/08 75 -231 kW	24-105910 $\frac{1}{H}$	24-105927 $\frac{1}{O}$	with standard chassis; without Airmatic DC
B4	E 200 CDI, E 200 CGI, E 200 Kompressor, E 200 NGT, E 220 CDI, E 230, E 240, E 270 CDI, E 280, E 280 CDI, E 300 BLUETEC, E 320, E 320 CDI, E 350, E 350 CGI, E 400 CDI, E 420 CDI 03/02 - 12/08 75 -231 kW	24-121774 $\frac{1}{H}$	24-105927 $\frac{1}{O}$	with off-road suspension; without Airmatic DC
B4	E 200 CDI, E 200 CGI, E 200 Kompressor, E 200 NGT, E 220 CDI, E 230, E 240, E 270 CDI, E 280, E 280 CDI, E 300 BLUETEC, E 320, E 320 CDI, E 350, E 350 CGI, E 400 CDI, E 420 CDI 03/02 - 12/08 75 -231 kW	24-121781 $\frac{1}{H}$	24-105927 $\frac{1}{O}$	with sports suspension; without Airmatic DC
B4	E 200 CDI, E 200 CGI, E 200 Kompressor, E 200 NGT, E 220 CDI, E 230, E 240, E 270 CDI, E 280, E 280 CDI, E 300 BLUETEC, E 320, E 320 CDI, E 350, E 350 CGI, E 400 CDI, E 420 CDI 03/02 - 12/08 75 -231 kW	24-121798 $\frac{1}{H}$	24-105927 $\frac{1}{O}$	without Airmatic DC; mark: Elegance; mark: Avantgarde
B4 AMC	E 240 4-matic, E 280 4-matic, E 280 CDI 4-matic, E 320 4-matic, E 320 CDI 4-matic, E 350 4-matic, E 500 4-matic 03/03 - 12/08 130 -285 kW	44-181666 $\frac{1}{H}$ 44-181680 $\frac{1}{H}$	40-076614 $\frac{1}{O}$ 40-076621 $\frac{1}{O}$ 19-050027 $\frac{1}{O}$	with Airmatic DC
B4 AMC	E 55 AMG Kompressor, E 63 AMG 10/02 - 12/08 350 -378 kW	44-143657 $\frac{1}{H}$ 44-143664 $\frac{1}{H}$	40-076676 $\frac{1}{O}$ 40-076683 $\frac{1}{O}$ 20-070915 $\frac{1}{O}$	with Airmatic DC
B4 AMC	E 200 CDI, E 200 CGI, E 200 Kompressor, E 220 CDI, E 240, E 270 CDI, E 320, E 320 CDI, E 400 CDI, E 500 03/02 - 06/03 75 -225 kW	44-100834 $\frac{1}{H}$ 44-100827 $\frac{1}{H}$	40-076614 $\frac{1}{O}$ 40-076621 $\frac{1}{O}$ 19-050027 $\frac{1}{O}$	-> CH.Nr.: A 334970; -> CH.Nr.: X 108179; with Airmatic DC
B4 AMC	E 200 CDI, E 200 CGI, E 200 Kompressor, E 220 CDI, E 240, E 270 CDI, E 320, E 320 CDI, E 400 CDI, E 500 06/03 - 12/08 75 -225 kW	44-102265 $\frac{1}{H}$ 44-102272 $\frac{1}{H}$	40-076614 $\frac{1}{O}$ 40-076621 $\frac{1}{O}$ 20-101893 $\frac{1}{O}$	CH.Nr.: X 108180 ->; CH.Nr.: A 334971 ->; with Airmatic DC
B6 Sport	E 200 CDI, E 200 CGI, E 200 Kompressor, E 200 NGT, E 220 CDI, E 230, E 240, E 270 CDI, E 280, E 280 CDI, E 300 BLUETEC, E 320, E 320 CDI, E 350, E 350 CGI, E 400 CDI, E 420 CDI 03/02 - 12/08 75 -231 kW	24-069052 $\frac{1}{H}$	24-069069 $\frac{1}{O}$	with standard chassis; without Airmatic DC
B6 Sport	E 200 CDI, E 200 CGI, E 200 Kompressor, E 200 NGT, E 220 CDI, E 230, E 240, E 270 CDI, E 280, E 280 CDI, E 300 BLUETEC, E 320, E 320 CDI, E 350, E 350 CGI, E 400 CDI, E 420 CDI 03/02 - 12/08 75 -231 kW	24-120234 $\frac{1}{H}$	24-069083 $\frac{1}{O}$	with sports suspension; without Airmatic DC
B8	E 200 CDI, E 200 CGI, E 200 Kompressor, E 200 NGT, E 220 CDI, E 230, E 240, E 270 CDI, E 280, E 280 CDI, E 300 BLUETEC, E 320, E 320 CDI, E 350, E 350 CGI, E 400 CDI, E 420 CDI 03/02 - 12/08 75 -231 kW	24-069076 $\frac{1}{H}$	24-069083 $\frac{1}{O}$	without Airmatic DC; mark: Avantgarde; mark: Elegance

				
<b>MERCEDES-BENZ</b>				
<b>MERCEDES-BENZ E-CLASS (W211)</b>				
B8	E 200 CDI, E 200 CGI, E 200 Kompressor, E 200 NGT, E 220 CDI, E 230, E 240, E 270 CDI, E 280, E 280 CDI, E 300 BLUETEC, E 320, E 320 CDI, E 350, E 350 CGI, E 400 CDI, E 420 CDI 03/02 - 12/08 75 -231 kW	24-120241 $\frac{1}{H}$	24-120227 $\frac{1}{O}$	with sports suspension; without Airmatic DC
B12 PK	E 200 CDI, E 200 CGI, E 200 Kompressor, E 220 CDI, E 240, E 350 03/02 - 12/08 75 -200 kW	46-181879		spring pads must be observed; with standard chassis; without Airmatic DC; without ride height adjustment; Conditions see certificates VA: lowering (expertise): 30-35 mm; axle load to: 1095 kg HA: lowering (expertise): 30 mm; axle load to: 1230 kg
B12 PK	E 200 CDI, E 200 CGI, E 200 Kompressor, E 220 CDI, E 240, E 350 03/02 - 12/08 75 -200 kW	46-181879		spring pads must be observed; without Airmatic DC; mark: Avantgarde, Elegance; without ride height adjustment; Conditions see certificates VA: lowering (expertise): 15-20 mm; axle load to: 1095 kg HA: lowering (expertise): 15 mm; axle load to: 1230 kg
B12 PK	E 220 CDI, E 270 CDI, E 320, E 320 CDI 03/02 - 12/08 100 -165 kW	46-181862		spring pads must be observed; with standard chassis; without Airmatic DC; without ride height adjustment; Conditions see certificates VA: lowering (expertise): 35-40 mm; axle load to: 1160 kg HA: lowering (expertise): 30 mm; axle load to: 1230 kg
B12 PK	E 220 CDI, E 270 CDI, E 320, E 320 CDI 03/02 - 12/08 100 -165 kW	46-181862		spring pads must be observed; without Airmatic DC; mark: Avantgarde, Elegance; without ride height adjustment; Conditions see certificates VA: lowering (expertise): 20-25 mm; axle load to: 1160 kg HA: lowering (expertise): 15 mm; axle load to: 1230 kg
B16 PSS9	E 200 CDI, E 200 CGI, E 200 Kompressor, E 200 NGT, E 220 CDI, E 230, E 240, E 270 CDI, E 280, E 280 CDI, E 300 BLUETEC, E 320, E 320 CDI, E 350, E 350 CGI, E 400 CDI, E 420 CDI 03/02 - 12/08 75 -231 kW	48-088763		without Airmatic DC; Conditions see certificates VA: lowering (expertise): 30-50 mm; axle load to: 1175 kg HA: lowering (expertise): 30-50 mm; axle load to: 1255 kg
B16 RC	E 200 CDI, E 200 CGI, E 200 Kompressor, E 200 NGT, E 220 CDI, E 230, E 240, E 270 CDI, E 280, E 280 CDI, E 300 BLUETEC, E 320, E 320 CDI, E 350, E 350 CGI, E 400 CDI, E 420 CDI 03/02 - 12/08 75 -231 kW	14-230615  49-132380		without Airmatic DC; Conditions see certificates VA: lowering (expertise): 30-50 mm; axle load to: 1175 kg HA: lowering (expertise): 30-50 mm; axle load to: 1255 kg

<b>MERCEDES-BENZ E-CLASS T-Model (S211)</b>				
B1	E 200 T Kompressor, E 220 T CDI, E 230 T, E 240 T, E 270 T CDI, E 320 T, E 320 T CDI 03/03 - 07/09 110 -165 kW	12-117864		VA: without ball bearing
B3	E 200 Kompressor, E 200 T Kompressor, E 220 T CDI, E 240 T 03/03 - 07/09 110 -135 kW	37-154110		with standard chassis; with ride height adjustment
B3	E 200 Kompressor, E 200 T Kompressor, E 220 T CDI, E 240 T 03/03 - 07/09 110 -135 kW	36-226153		with standard chassis; Heavy Duty Version .; with ride height adjustment
B3	E 200 Kompressor, E 200 T Kompressor, E 240 T 03/03 - 07/09 120 -135 kW	37-163747		with standard chassis; mark: Avantgarde; with ride height adjustment
B3	E 220 T CDI 03/03 - 07/09 110 -125 kW	37-163747		with standard chassis; mark: Avantgarde; with ride height adjustment
B3	E 220 T CDI 03/03 - 07/09 110 -125 kW	36-226153		with standard chassis; Heavy Duty Version .; mark: Avantgarde; with ride height adjustment
B3	E 270 T CDI, E 280 T, E 280 T CDI, E 320 T, E 320 T CDI 03/03 - 07/09 120 -170 kW	36-226153		with standard chassis; with ride height adjustment
B3	E 270 T CDI, E 280 T, E 280 T CDI, E 320 T, E 320 T CDI 03/03 - 07/09 120 -170 kW	37-163761		with standard chassis; mark: Avantgarde; with ride height adjustment

				
<b>MERCEDES-BENZ</b>				
<b>MERCEDES-BENZ E-CLASS T-Model (S211)</b>				
B4	350 CGI, E 200 CDI, E 200 Kompressor, E 200 T Kompressor, E 220 CDI, E 220 T CDI, E 230 T, E 240 T, E 270 T CDI, E 280 T, E 280 T CDI, E 320 T, E 320 T CDI, E 350 T 03/05 - 07/09 100 -215 kW	24-105910 $\frac{1}{H}$	19-235219 $\frac{1}{O}$ 40-076638	with standard chassis; without Airmatic DC; with ride height adjustment
B4	350 CGI, E 200 CDI, E 200 Kompressor, E 200 T Kompressor, E 220 CDI, E 220 T CDI, E 230 T, E 240 T, E 270 T CDI, E 280 T, E 280 T CDI, E 320 T, E 320 T CDI, E 350 T 03/05 - 07/09 100 -215 kW	24-105910 $\frac{1}{H}$	40-076638 24-068741 $\frac{1}{O}$	with standard chassis; without Airmatic DC; mark: Avantgarde; with ride height adjustment
B4	350 CGI, E 200 CDI, E 200 Kompressor, E 200 T Kompressor, E 220 CDI, E 220 T CDI, E 230 T, E 240 T, E 270 T CDI, E 280 T, E 280 T CDI, E 320 T, E 320 T CDI, E 350 T 03/05 - 07/09 100 -215 kW	24-121781 $\frac{1}{H}$	40-076638 24-068734 $\frac{1}{O}$	with sports suspension; without Airmatic DC; with ride height adjustment
B4 AMC	E 200 T Kompressor, E 220 CDI, E 220 T CDI, E 240 T, E 270 T CDI, E 320 T CDI 03/03 - 06/03 100 -150 kW	44-100834 $\frac{1}{H}$ 44-100827 $\frac{1}{H}$	40-076614 $\frac{1}{O}$ 20-070861 $\frac{1}{O}$ 40-076621 $\frac{1}{O}$ 20-070878 $\frac{1}{O}$	-> CH.Nr.: A 334970; -> CH.Nr.: X 105579; with Airmatic DC
B4 AMC	3.5 4-matic, E 240 T 4-matic, E 280 T 4-matic, E 280 T CDI 4-matic, E 320 T 4-matic, E 320 T CDI 4-matic, E 350 T 4-matic, E 500 T 4-matic 10/03 - 07/09 130 -285 kW	44-181666 $\frac{1}{H}$ 44-181680 $\frac{1}{H}$	26-220048 $\frac{1}{O}$ 40-076614 $\frac{1}{O}$ 26-220055 $\frac{1}{O}$ 40-076621 $\frac{1}{O}$	with Airmatic DC
B4 AMC	350 CGI, E 200 Kompressor, E 220 T CDI, E 280 T, E 280 T CDI, E 320 T, E 320 T CDI, E 350 T, E 500 T 04/06 - 07/09 120 -285 kW	44-102265 $\frac{1}{H}$ 44-102272 $\frac{1}{H}$	40-076614 $\frac{1}{O}$ 20-070861 $\frac{1}{O}$ 40-076621 $\frac{1}{O}$ 20-070878 $\frac{1}{O}$	with Airmatic DC
B4 AMC	E 55 T AMG Kompressor, E 63 AMG 07/03 - 07/09 350 -378 kW	44-143657 $\frac{1}{H}$ 44-143664 $\frac{1}{H}$		with Airmatic DC
B4 AMC	E 200 CDI, E 200 T Kompressor, E 220 CDI, E 220 T CDI, E 230 T, E 240 T, E 270 T CDI, E 320 T CDI, E 500 T 06/03 - 07/09 100 -225 kW	44-102265 $\frac{1}{H}$ 44-102272 $\frac{1}{H}$	40-076614 $\frac{1}{O}$ 20-070861 $\frac{1}{O}$ 40-076621 $\frac{1}{O}$ 20-070878 $\frac{1}{O}$	CH.Nr.: A 334971 ->; CH.Nr.: X 105580 ->; with Airmatic DC
B6 Sport	350 CGI, E 200 CDI, E 200 Kompressor, E 200 T Kompressor, E 220 CDI, E 220 T CDI, E 230 T, E 240 T, E 270 T CDI, E 280 T, E 280 T CDI, E 320 T, E 320 T CDI, E 350 T 03/05 - 07/09 100 -215 kW	24-069052 $\frac{1}{H}$	27-105993 $\frac{1}{O}$	with standard chassis; without Airmatic DC HA: with ride height adjustment
B8	350 CGI, E 200 CDI, E 200 Kompressor, E 200 T Kompressor, E 220 CDI, E 220 T CDI, E 230 T, E 240 T, E 270 T CDI, E 280 T, E 280 T CDI, E 320 T, E 320 T CDI, E 350 T 03/05 - 07/09 100 -215 kW	24-069076 $\frac{1}{H}$	27-105993 $\frac{1}{O}$	with sports suspension; without Airmatic DC HA: with ride height adjustment
B12 PK	E 200 T Kompressor, E 220 CDI, E 220 T CDI, E 230 T, E 240 T, E 350 T 03/03 - 07/09 100 -200 kW		46-190499	without Airmatic DC; Conditions see certificates VA: lowering (expertise): 30-35 mm; axle load to: 1095 kg HA: with ride height adjustment; lowering (expertise): 30 mm; axle load to: 1230 kg
B12 PK	E 220 T CDI, E 270 T CDI, E 280 T CDI, E 320 T, E 320 T CDI, E 350 T 03/03 - 07/09 110 -200 kW		46-190505	without Airmatic DC; Conditions see certificates VA: lowering (expertise): 30-35 mm; axle load to: 1160 kg HA: with ride height adjustment; lowering (expertise): 30 mm; axle load to: 1230 kg



# New order number – Old order number

New	Old	Page	New	Old	Page	New	Old	Page	New	Old	Page	New	Old	Page
11-101291	ASP-A129	357	11-101314	ASP-A131	714	11-101369	ASP-A136	315	11-101918	ASP-A191	696	11-122456	ASP-C245	728
11-101291	ASP-A129	636	11-101314	ASP-A131	727	11-101369	ASP-A136	316	11-101918	ASP-A191	697	11-122456	ASP-C245	729
11-101291	ASP-A129	637	11-101314	ASP-A131	729	11-101369	ASP-A136	493	11-103455	ASP-A345	17	11-122456	ASP-C245	742
11-101291	ASP-A129	640	11-101314	ASP-A131	730	11-101369	ASP-A136	494	11-103455	ASP-A345	646	11-122456	ASP-C245	743
11-101291	ASP-A129	641	11-101314	ASP-A131	731	11-101369	ASP-A136	495	11-103455	ASP-A345	653	11-125358	ASP-C535	384
11-101291	ASP-A129	642	11-101314	ASP-A131	732	11-101369	ASP-A136	496	11-103455	ASP-A345	660	11-125358	ASP-C535	386
11-101291	ASP-A129	645	11-101314	ASP-A131	733	11-101369	ASP-A136	497	11-103455	ASP-A345	662	11-149828	ASP-E982	602
11-101291	ASP-A129	650	11-101314	ASP-A131	740	11-101369	ASP-A136	511	11-103455	ASP-A345	775	11-149828	ASP-E982	603
11-101291	ASP-A129	651	11-101314	ASP-A131	741	11-101369	ASP-A136	532	11-103455	ASP-A345	776	11-149828	ASP-E982	635
11-101291	ASP-A129	652	11-101314	ASP-A131	742	11-101369	ASP-A136	537	11-103455	ASP-A345	777	11-149828	ASP-E982	817
11-101291	ASP-A129	778	11-101314	ASP-A131	745	11-101369	ASP-A136	714	11-103455	ASP-A345	779	11-149828	ASP-E982	818
11-101291	ASP-A129	781	11-101314	ASP-A131	747	11-101369	ASP-A136	715	11-103455	ASP-A345	780	11-149835	ASP-E983	38
11-101291	ASP-A129	784	11-101314	ASP-A131	760	11-101369	ASP-A136	716	11-103455	ASP-A345	791	11-149835	ASP-E983	41
11-101291	ASP-A129	785	11-101314	ASP-A131	761	11-101369	ASP-A136	717	11-103455	ASP-A345	793	11-149835	ASP-E983	42
11-101291	ASP-A129	786	11-101314	ASP-A131	762	11-101369	ASP-A136	728	11-103455	ASP-A345	819	11-149835	ASP-E983	43
11-101291	ASP-A129	787	11-101314	ASP-A131	769	11-101369	ASP-A136	743	11-103455	ASP-A345	870	11-149835	ASP-E983	62
11-101291	ASP-A129	788	11-101314	ASP-A131	770	11-101369	ASP-A136	754	11-103455	ASP-A345	874	11-149835	ASP-E983	64
11-101291	ASP-A129	789	11-101321	ASP-A132	1	11-101376	ASP-A137	196	11-103455	ASP-A345	875	11-149835	ASP-E983	93
11-101291	ASP-A129	790	11-101321	ASP-A132	2	11-101376	ASP-A137	197	11-103455	ASP-A345	876	11-149835	ASP-E983	671
11-101291	ASP-A129	795	11-101321	ASP-A132	16	11-101376	ASP-A137	198	11-103462	ASP-A346	33	11-149835	ASP-E983	827
11-101291	ASP-A129	813	11-101321	ASP-A132	104	11-101376	ASP-A137	208	11-103462	ASP-A346	34	11-149835	ASP-E983	828
11-101291	ASP-A129	823	11-101321	ASP-A132	106	11-101376	ASP-A137	209	11-103462	ASP-A346	65	11-149835	ASP-E983	829
11-101291	ASP-A129	824	11-101321	ASP-A132	136	11-101376	ASP-A137	210	11-103622	ASP-A362	767	11-149835	ASP-E983	831
11-101291	ASP-A129	825	11-101321	ASP-A132	137	11-101376	ASP-A137	211	11-103622	ASP-A362	768	11-149835	ASP-E983	833
11-101291	ASP-A129	826	11-101321	ASP-A132	138	11-101376	ASP-A137	377	11-103622	ASP-A362	769	11-181415	ASP-E180	13
11-101291	ASP-A129	842	11-101321	ASP-A132	140	11-101376	ASP-A137	436	11-103622	ASP-A362	770	11-181415	ASP-E180	14
11-101291	ASP-A129	843	11-101321	ASP-A132	147	11-101376	ASP-A137	437	11-103622	ASP-A362	771	11-181415	ASP-E180	107
11-101291	ASP-A129	844	11-101321	ASP-A132	155	11-101376	ASP-A137	556	11-103622	ASP-A362	772	11-181415	ASP-E180	108
11-101291	ASP-A129	845	11-101321	ASP-A132	235	11-101376	ASP-A137	557	11-103943	ASP-A394	59	11-181415	ASP-E180	110
11-101291	ASP-A129	850	11-101321	ASP-A132	639	11-101376	ASP-A137	558	11-103943	ASP-A394	60	11-181415	ASP-E180	111
11-101291	ASP-A129	851	11-101321	ASP-A132	643	11-101376	ASP-A137	565	11-103943	ASP-A394	70	11-181415	ASP-E180	112
11-101291	ASP-A129	857	11-101321	ASP-A132	650	11-101376	ASP-A137	566	11-103943	ASP-A394	85	11-181415	ASP-E180	113
11-101291	ASP-A129	858	11-101321	ASP-A132	651	11-101376	ASP-A137	567	11-103943	ASP-A394	86	11-181415	ASP-E180	114
11-101291	ASP-A129	874	11-101321	ASP-A132	656	11-101376	ASP-A137	571	11-103943	ASP-A394	87	11-181415	ASP-E180	115
11-101307	ASP-A130	77	11-101321	ASP-A132	657	11-101376	ASP-A137	572	11-103943	ASP-A394	88	11-181415	ASP-E180	116
11-101307	ASP-A130	78	11-101321	ASP-A132	658	11-101376	ASP-A137	579	11-103943	ASP-A394	89	11-181415	ASP-E180	117
11-101307	ASP-A130	79	11-101321	ASP-A132	659	11-101376	ASP-A137	580	11-103943	ASP-A394	90	11-181415	ASP-E180	118
11-101307	ASP-A130	80	11-101321	ASP-A132	670	11-101390	ASP-A139	29	11-103943	ASP-A394	91	11-181415	ASP-E180	119
11-101307	ASP-A130	81	11-101321	ASP-A132	671	11-101390	ASP-A139	30	11-104322	ASP-A432	788	11-181415	ASP-E180	120
11-101307	ASP-A130	82	11-101321	ASP-A132	846	11-101390	ASP-A139	33	11-104322	ASP-A432	789	11-181415	ASP-E180	121
11-101307	ASP-A130	83	11-101321	ASP-A132	847	11-101390	ASP-A139	62	11-104957	ASP-A495	280	11-181415	ASP-E180	160
11-101307	ASP-A130	84	11-101321	ASP-A132	848	11-101390	ASP-A139	77	11-104957	ASP-A495	281	11-223900		595
11-101307	ASP-A130	86	11-101338	ASP-A133	242	11-101390	ASP-A139	93	11-104957	ASP-A495	303	11-223900		596
11-101307	ASP-A130	635	11-101338	ASP-A133	243	11-101390	ASP-A139	782	11-104964	ASP-A496	280	11-239734		59
11-101307	ASP-A130	640	11-101338	ASP-A133	249	11-101390	ASP-A139	825	11-104964	ASP-A496	281	11-239734		60
11-101307	ASP-A130	645	11-101338	ASP-A133	258	11-101390	ASP-A139	840	11-104964	ASP-A496	303	11-239734		61
11-101307	ASP-A130	650	11-101338	ASP-A133	259	11-101390	ASP-A139	841	11-105886	ASP-A588	263	11-239734		70
11-101307	ASP-A130	652	11-101338	ASP-A133	260	11-101390	ASP-A139	842	11-105886	ASP-A588	264	11-239734		71
11-101307	ASP-A130	778	11-101338	ASP-A133	261	11-101406	ASP-A140	387	11-105886	ASP-A588	265	11-239734		85
11-101307	ASP-A130	779	11-101338	ASP-A133	262	11-101406	ASP-A140	407	11-105886	ASP-A588	266	11-239734		87
11-101307	ASP-A130	780	11-101338	ASP-A133	263	11-101406	ASP-A140	408	11-105886	ASP-A588	267	11-239734		88
11-101307	ASP-A130	784	11-101338	ASP-A133	265	11-101406	ASP-A140	412	11-105886	ASP-A588	269	11-239734		89
11-101307	ASP-A130	817	11-101338	ASP-A133	266	11-101406	ASP-A140	413	11-105886	ASP-A588	367	11-239734		90
11-101307	ASP-A130	818	11-101338	ASP-A133	267	11-101406	ASP-A140	414	11-105886	ASP-A588	368	11-239734		91
11-101307	ASP-A130	820	11-101338	ASP-A133	269	11-101413	ASP-A141	85	11-106470	ASP-A647	639	11-240457		433
11-101307	ASP-A130	821	11-101338	ASP-A133	285	11-101437	ASP-A143	288	11-106470	ASP-A647	643	12-116614	AFS-B661	193
11-101307	ASP-A130	822	11-101338	ASP-A133	286	11-101437	ASP-A143	289	11-106470	ASP-A647	644	12-116614	AFS-B661	556
11-101307	ASP-A130	843	11-101338	ASP-A133	360	11-101437	ASP-A143	290	11-106470	ASP-A647	645	12-116621	AFS-B662	193
11-101307	ASP-A130	845	11-101345	ASP-A134	78	11-101437	ASP-A143	337	11-106470	ASP-A647	656	12-116621	AFS-B662	208
11-101307	ASP-A130	848	11-101345	ASP-A134	79	11-101451	ASP-A145	136	11-106470	ASP-A647	657	12-116621	AFS-B662	556
11-101307	ASP-A130	849	11-101345	ASP-A134	83	11-101451	ASP-A145	147	11-106470	ASP-A647	658	12-116669	AFS-B666	260
11-101307	ASP-A130	850	11-101345	ASP-A134	84	11-101468	ASP-A146	263	11-106470	ASP-A647	659	12-116669	AFS-B666	261
11-101314	ASP-A131	165	11-101345	ASP-A134	104	11-101468	ASP-A146	264	11-106470	ASP-A647	670	12-116669	AFS-B666	262
11-101314	ASP-A131	167	11-101345	ASP-A134	780	11-101468	ASP-A146	265	11-106470	ASP-A647	671	12-116669	AFS-B666	263
11-101314	ASP-A131	177	11-101345	ASP-A134	784	11-101468	ASP-A146	266	11-106470	ASP-A647	842	12-116669	AFS-B666	285
11-101314	ASP-A131	178	11-101345	ASP-A134	812	11-101468	ASP-A146	267	11-106470	ASP-A647	844	12-116676	AFS-B667	257
11-101314	ASP-A131	181	11-101345	ASP-A134	851	11-101468	ASP-A146	268	11-106470	ASP-A647	845	12-116676	AFS-B667	280
11-101314	ASP-A131	183	11-101352	ASP-A135	636	11-101468	ASP-A146	269	11-106470	ASP-A647	846	12-116676	AFS-B667	281
11-101314	ASP-A131	184	11-101352	ASP-A135	637	11-101468	ASP-A146	367	11-106470	ASP-A647	847	12-116744	AFS-B674	235
11-101314	ASP-A131	218	11-101352	ASP-A135	638	11-101468	ASP-A146	368	11-106470	ASP-A647	848	12-116768	AFS-B676	77
11-101314	ASP-A131	219	11-101352	ASP-A135	639	11-101499	ASP-A149	227	11-106487	ASP-A648	843	12-116768	AFS-B676	78
11-101314	ASP-A131	220	11-101352	ASP-A135	641	11-101499	ASP-A149	228	11-106487	ASP-A648	844	12-116768	AFS-B676	79
11-101314	ASP-A131	221	11-101352	ASP-A135	642	11-101499	ASP-A149	229	11-115755	ASP-B575	17	12-116768	AFS-B676	80
11-101314	ASP-A131	315	11-101352	ASP-A135	651	11-101499	ASP-A149	247	11-115755	ASP-B575	646	12-116768	AFS-B676	81
11-101314	ASP-A131	320	11-101352	ASP-A135	652	11-1014								



# New order number – Old order number

New	Old	Page	New	Old	Page	New	Old	Page	New	Old	Page	New	Old	Page
12-116805	AFS-B680	541	12-117086	AFS-B708	60	12-117376	AFS-B737	552	12-117598	AFS-B759	142	12-125104	AFS-C510	315
12-116805	AFS-B680	542	12-117086	AFS-B708	70	12-117376	AFS-B737	718	12-117628	AFS-B762	104	12-125104	AFS-C510	527
12-116805	AFS-B680	727	12-117086	AFS-B708	85	12-117376	AFS-B737	719	12-117628	AFS-B762	106	12-125104	AFS-C510	528
12-116805	AFS-B680	730	12-117086	AFS-B708	87	12-117376	AFS-B737	720	12-117628	AFS-B762	136	12-125104	AFS-C510	529
12-116812	AFS-B681	315	12-117086	AFS-B708	88	12-117376	AFS-B737	721	12-117628	AFS-B762	137	12-125104	AFS-C510	530
12-116812	AFS-B681	316	12-117086	AFS-B708	89	12-117376	AFS-B737	722	12-117628	AFS-B762	140	12-167616	AFS-G761	433
12-116812	AFS-B681	493	12-117086	AFS-B708	90	12-117376	AFS-B737	739	12-117628	AFS-B762	147	12-173495	AFS-H349	432
12-116812	AFS-B681	494	12-117093	AFS-B709	104	12-117376	AFS-B737	746	12-117628	AFS-B762	155	12-224036		511
12-116812	AFS-B681	495	12-117093	AFS-B709	106	12-117376	AFS-B737	747	12-117635	AFS-B763	510	12-224036		512
12-116812	AFS-B681	496	12-117109	AFS-B710	107	12-117376	AFS-B737	748	12-117635	AFS-B763	541	12-224036		517
12-116812	AFS-B681	497	12-117109	AFS-B710	110	12-117376	AFS-B737	754	12-117635	AFS-B763	542	12-224036		732
12-116812	AFS-B681	714	12-117109	AFS-B710	112	12-117383	AFS-B738	77	12-117635	AFS-B763	730	12-224074		18
12-116812	AFS-B681	715	12-117109	AFS-B710	114	12-117383	AFS-B738	781	12-117635	AFS-B763	731	12-224074		22
12-116812	AFS-B681	716	12-117109	AFS-B710	115	12-117383	AFS-B738	782	12-117642	AFS-B764	29	12-224074		26
12-116812	AFS-B681	717	12-117109	AFS-B710	116	12-117383	AFS-B738	840	12-117642	AFS-B764	33	12-224074		75
12-116829	AFS-B682	107	12-117109	AFS-B710	117	12-117383	AFS-B738	841	12-117642	AFS-B764	36	12-224074		76
12-116829	AFS-B682	110	12-117109	AFS-B710	120	12-117383	AFS-B738	842	12-117642	AFS-B764	40	12-224074		632
12-116829	AFS-B682	112	12-117109	AFS-B710	155	12-117390	AFS-B739	316	12-117642	AFS-B764	61	12-224074		633
12-116829	AFS-B682	114	12-117116	AFS-B711	137	12-117390	AFS-B739	317	12-117642	AFS-B764	63	12-224074		647
12-116829	AFS-B682	155	12-117116	AFS-B711	140	12-117390	AFS-B739	320	12-117642	AFS-B764	71	12-224074		654
12-116836	AFS-B683	230	12-117123	AFS-B712	141	12-117390	AFS-B739	498	12-117642	AFS-B764	826	12-224074		663
12-116836	AFS-B683	243	12-117130	AFS-B713	149	12-117390	AFS-B739	499	12-117642	AFS-B764	828	12-224074		664
12-116836	AFS-B683	244	12-117154	AFS-B715	267	12-117390	AFS-B739	500	12-117642	AFS-B764	830	12-224074		672
12-116843	AFS-B684	237	12-117154	AFS-B715	269	12-117390	AFS-B739	501	12-117642	AFS-B764	832	12-224074		673
12-116843	AFS-B684	360	12-117161	AFS-B716	267	12-117390	AFS-B739	502	12-117659	AFS-B765	277	12-224074		674
12-116850	AFS-B685	227	12-117161	AFS-B716	269	12-117390	AFS-B739	516	12-117659	AFS-B765	631	12-224074		779
12-116850	AFS-B685	228	12-117161	AFS-B716	278	12-117390	AFS-B739	518	12-117659	AFS-B765	635	12-224074		780
12-116850	AFS-B685	233	12-117161	AFS-B716	286	12-117390	AFS-B739	540	12-117659	AFS-B765	637	12-224074		782
12-116850	AFS-B685	234	12-117161	AFS-B716	367	12-117390	AFS-B739	543	12-117659	AFS-B765	638	12-224074		795
12-116867	AFS-B686	261	12-117185	AFS-B718	257	12-117390	AFS-B739	544	12-117659	AFS-B765	640	12-224074		798
12-116867	AFS-B686	263	12-117185	AFS-B718	280	12-117390	AFS-B739	546	12-117659	AFS-B765	645	12-224074		800
12-116867	AFS-B686	264	12-117185	AFS-B718	281	12-117390	AFS-B739	718	12-117659	AFS-B765	651	12-224074		804
12-116867	AFS-B686	265	12-117239	AFS-B723	635	12-117390	AFS-B739	719	12-117659	AFS-B765	778	12-224074		806
12-116867	AFS-B686	266	12-117239	AFS-B723	637	12-117390	AFS-B739	720	12-117659	AFS-B765	779	12-224074		809
12-116928	AFS-B692	407	12-117239	AFS-B723	638	12-117390	AFS-B739	721	12-117659	AFS-B765	786	12-224074		813
12-116928	AFS-B692	408	12-117239	AFS-B723	641	12-117390	AFS-B739	722	12-117659	AFS-B765	788	12-224074		816
12-116928	AFS-B692	409	12-117239	AFS-B723	780	12-117390	AFS-B739	734	12-117659	AFS-B765	790	12-224074		834
12-116928	AFS-B692	412	12-117239	AFS-B723	784	12-117390	AFS-B739	735	12-117659	AFS-B765	795	12-224074		836
12-116928	AFS-B692	413	12-117239	AFS-B723	786	12-117390	AFS-B739	745	12-117659	AFS-B765	823	12-224074		837
12-116928	AFS-B692	414	12-117239	AFS-B723	788	12-117390	AFS-B739	747	12-117659	AFS-B765	824	12-224074		838
12-116935	AFS-B693	532	12-117239	AFS-B723	790	12-117390	AFS-B739	748	12-117659	AFS-B765	843	12-224074		839
12-116935	AFS-B693	533	12-117239	AFS-B723	813	12-117444	AFS-B744	606	12-117659	AFS-B765	844	12-224074		840
12-116935	AFS-B693	534	12-117239	AFS-B723	842	12-117444	AFS-B744	607	12-117659	AFS-B765	850	12-224074		852
12-116935	AFS-B693	537	12-117239	AFS-B723	843	12-117451	AFS-B745	606	12-117659	AFS-B765	853	12-224074		854
12-116959	AFS-B695	635	12-117239	AFS-B723	844	12-117451	AFS-B745	607	12-117659	AFS-B765	857	12-224074		855
12-116959	AFS-B695	817	12-117239	AFS-B723	857	12-117475	AFS-B747	78	12-117703	AFS-B770	142	12-224074		870
12-116959	AFS-B695	842	12-117253	AFS-B725	150	12-117475	AFS-B747	79	12-117741	AFS-B774	639	12-224074		872
12-116959	AFS-B695	845	12-117260	AFS-B726	95	12-117475	AFS-B747	80	12-117741	AFS-B774	643	12-224074		875
12-116966	AFS-B696	15	12-117260	AFS-B726	97	12-117475	AFS-B747	81	12-117741	AFS-B774	845	12-224074		876
12-116966	AFS-B696	16	12-117260	AFS-B726	98	12-117475	AFS-B747	82	12-117772	AFS-B777	512	12-224074		877
12-116966	AFS-B696	73	12-117260	AFS-B726	99	12-117475	AFS-B747	83	12-117772	AFS-B777	513	12-224081		18
12-116966	AFS-B696	74	12-117260	AFS-B726	115	12-117475	AFS-B747	84	12-117772	AFS-B777	514	12-224081		26
12-116966	AFS-B696	634	12-117260	AFS-B726	116	12-117475	AFS-B747	820	12-117796	AFS-B779	572	12-224081		632
12-116966	AFS-B696	643	12-117260	AFS-B726	117	12-117475	AFS-B747	821	12-117796	AFS-B779	573	12-224081		633
12-116966	AFS-B696	644	12-117260	AFS-B726	119	12-117475	AFS-B747	822	12-117796	AFS-B779	574	12-224081		647
12-116966	AFS-B696	645	12-117260	AFS-B726	120	12-117475	AFS-B747	849	12-117802	AFS-B780	559	12-224081		672
12-116966	AFS-B696	652	12-117260	AFS-B726	122	12-117475	AFS-B747	850	12-117802	AFS-B780	560	12-224081		673
12-116966	AFS-B696	660	12-117260	AFS-B726	125	12-117499	AFS-B749	204	12-117802	AFS-B780	561	12-224081		674
12-116966	AFS-B696	661	12-117260	AFS-B726	141	12-117499	AFS-B749	206	12-117819	AFS-B781	559	12-224081		773
12-116966	AFS-B696	662	12-117260	AFS-B726	142	12-117499	AFS-B749	207	12-117819	AFS-B781	560	12-224081		774
12-116966	AFS-B696	670	12-117260	AFS-B726	144	12-117499	AFS-B749	243	12-117819	AFS-B781	561	12-224081		782
12-116966	AFS-B696	671	12-117260	AFS-B726	145	12-117499	AFS-B749	248	12-117840	AFS-B784	15	12-224081		795
12-116966	AFS-B696	774	12-117260	AFS-B726	147	12-117499	AFS-B749	360	12-117840	AFS-B784	16	12-224081		798
12-116966	AFS-B696	776	12-117260	AFS-B726	148	12-117499	AFS-B749	576	12-117840	AFS-B784	639	12-224081		800
12-116966	AFS-B696	790	12-117260	AFS-B726	152	12-117499	AFS-B749	577	12-117840	AFS-B784	642	12-224081		804
12-116966	AFS-B696	793	12-117260	AFS-B726	153	12-117499	AFS-B749	578	12-117840	AFS-B784	643	12-224081		806
12-116966	AFS-B696	819	12-117260	AFS-B726	154	12-117499	AFS-B749	579	12-117840	AFS-B784	661	12-224081		809
12-116966	AFS-B696	847	12-117260	AFS-B726	160	12-117505	AFS-B750	204	12-117840	AFS-B784	669	12-224081		813
12-116966	AFS-B696	856	12-117260	AFS-B726	162	12-117505	AFS-B750	206	12-117840	AFS-B784	670	12-224081		816
12-116966	AFS-B696	870	12-117291	AFS-B729	756	12-117505	AFS-B750	207	12-117840	AFS-B784	671	12-224081		834
12-116966	AFS-B696	876	12-117291	AFS-B729	757	12-117505	AFS-B750	243	12-117840	AFS-B784	774	12-224081		836
12-117000	AFS-B700	209	12-117314	AFS-B731	383	12-117505	AFS-B750	248	12-117840	AFS-B784	776	12-224081		837
12-117000	AFS-B700	210	12-117314	AFS-B731	386	12-117505	AFS-B750	360	12-117840	AFS-B784	790	12-224081		838
12-117000	AFS-B700	565	12-117321	AFS-B732	85	12-117505	AFS-B750	576	12-117840	AFS-B784	793	12-224081		839
12-117000	AFS-B700	566	12-117321	AFS-B732	87	12-117505	AFS-B750	577						



# New order number – Old order number

New	Old	Page	New	Old	Page	New	Old	Page	New	Old	Page	New	Old	Page
12-224135		281	12-224418	AFS-B761	141	12-226429		876	12-228676		582	12-234325		241
12-224135		282	12-224425	AFS-B766	141	12-226436		95	12-228676		583	12-234325		360
12-224135		283	12-224425	AFS-B766	158	12-226436		97	12-228683		213	12-234332		100
12-224142		281	12-224432		95	12-226436		98	12-228683		214	12-234332		102
12-224142		282	12-224432		97	12-226436		99	12-228683		254	12-234332		131
12-224159		391	12-224432		99	12-226436		122	12-228683		255	12-234332		133
12-224159		393	12-224432		122	12-226436		125	12-228683		256	12-234332		161
12-224159		394	12-224432		125	12-226436		127	12-228683		581	12-234622		146
12-224159		396	12-224432		127	12-226436		129	12-228683		582	12-234622		148
12-224159		403	12-224432		129	12-226443		95	12-228683		583	12-234622		149
12-224159		404	12-224432		144	12-226443		97	12-228690		431	12-234622		152
12-224173		272	12-224432		145	12-226443		98	12-228713		671	12-238026		273
12-224173		273	12-224449		503	12-226443		99	12-228713		830	12-238026		274
12-224173		274	12-224449		504	12-226443		122	12-228720		61	12-238026		275
12-224173		275	12-224449		505	12-226443		125	12-228720		63	12-238026		372
12-224180		607	12-224449		506	12-226443		127	12-228720		830	12-238026		373
12-224180		608	12-224449		507	12-226443		129	12-228744		608	12-238026		374
12-224197		177	12-224449		553	12-226450		11	12-228751		613	12-238026		756
12-224197		178	12-224449		722	12-226450		240	12-228751		614	12-238026		757
12-224197		320	12-224449		723	12-226450		241	12-228751		616	12-238026		758
12-224197		511	12-224449		724	12-226467		11	12-228768		430	12-238026		761
12-224197		515	12-224456		503	12-226467		240	12-228775		430	12-238033		489
12-224197		516	12-224456		505	12-226467		241	12-228782		278	12-238033		555
12-224197		539	12-224456		506	12-226481		207	12-228782		291	12-238033		623
12-224197		732	12-224456		507	12-226481		233	12-228799		608	12-238033		624
12-224197		733	12-224456		553	12-226481		240	12-228799		609	12-238033		754
12-224197		745	12-224456		723	12-226481		242	12-228805		52	12-238088		168
12-224203	AFS-B767	601	12-224456		724	12-226481		578	12-228805		53	12-238088		231
12-224203	AFS-B767	616	12-224463		43	12-226504		207	12-228805		54	12-238088		538
12-224227		611	12-224463		44	12-226504		233	12-228805		55	12-238088		547
12-224227		612	12-224463		48	12-226504		240	12-228805		56	12-238088		548
12-224227		613	12-224463		69	12-226504		242	12-228805		57	12-238088		550
12-224227		615	12-224463		70	12-226504		578	12-228805		58	12-238088		627
12-224227		616	12-224463		639	12-226528		562	12-228805		72	12-238088		743
12-224234		235	12-224463		640	12-226528		563	12-228812		52	12-238088		749
12-224234		236	12-224470		44	12-226528		564	12-228812		54	12-238088		751
12-224234		238	12-224470		48	12-226535		22	12-228812		55	12-238088		752
12-224234		250	12-224470		66	12-226535		71	12-228812		57	12-238095		553
12-224234		877	12-224470		67	12-226535		75	12-228812		58	12-238149		204
12-224241		215	12-224470		69	12-226535		76	12-228812		72	12-242191		683
12-224241		216	12-224470		639	12-226535		632	12-228829		52	12-242191		687
12-224241		217	12-224470		640	12-226535		663	12-228829		53	12-242191		710
12-224241		356	12-224487		66	12-226535		664	12-228829		54	12-242733	AFS-B730	760
12-224241		604	12-224487		67	12-226535		674	12-228829		55	12-242733	AFS-B730	761
12-224241		609	12-224623		397	12-226535		840	12-228829		56	12-242733	AFS-B730	762
12-224241		615	12-224623		399	12-226535		854	12-228829		57	12-242733	AFS-B730	763
12-224258		198	12-224623		400	12-226535		855	12-228829		58	12-242733	AFS-B730	764
12-224258		199	12-225323		16	12-226542		198	12-228829		72	12-242740		759
12-224258		200	12-225323		642	12-226542		199	12-231409		490	12-242740		760
12-224265		444	12-225323		669	12-226542		200	12-231607		760	12-242740		761
12-224265		445	12-225323		670	12-226542		577	12-231607		763	12-242740		762
12-224265		446	12-225323		671	12-226559		203	12-231607		764	12-242740		764
12-224265		447	12-225323		846	12-226559		205	12-231614		759	12-243945		26
12-224265		448	12-225323		847	12-226559		570	12-231614		760	12-243945		28
12-224265		859	12-225347		257	12-226580		632	12-231621		72	12-243945		649
12-224265		860	12-225347		268	12-226580		854	12-231621		599	12-243945		667
12-224289		436	12-225347		269	12-228454		707	12-231621		854	12-243945		668
12-224289		437	12-225347		368	12-228461	AFS-B699	609	12-231638		278	12-243945		807
12-224296		453	12-225354		268	12-228461	AFS-B699	610	12-231638		283	12-243945		808
12-224296		454	12-225354		269	12-228461	AFS-B699	615	12-231638		284	12-243952		521
12-224302		144	12-225385		295	12-228478		340	12-231638		290	12-243952		522
12-224302		147	12-225385		297	12-228485		340	12-233939		572	12-243952		629
12-224302		151	12-225385		299	12-228492		3	12-233939		573	12-243952		737
12-224319		151	12-225828	AFS-B691	387	12-228492		5	12-233960		605	12-243952		738
12-224326		704	12-225835		397	12-228492		6	12-233960		617	14-230615		14
12-224326		705	12-225835		399	12-228492		9	12-234059		605	14-230615		15
12-224333		200	12-225835		436	12-228492		11	12-234059		618	14-230615		21
12-224333		202	12-225835		451	12-228508		3	12-234073		570	14-230615		22
12-224333		567	12-225842		397	12-228508		11	12-234073		578	14-230615		25
12-224333		568	12-225842		400	12-228515		5	12-234080		678	14-230615		26
12-224333		569	12-225842		436	12-228515		6	12-234080		679	14-230615		28
12-224333		570	12-225842		451	12-228522		192	12-234080		680	14-230615		29
12-224340		267	12-226344		423	12-228522		229	12-234080		681	14-230615		53
12-224340		269	12-226344		424	12-228522		244	12-234080		682	14-230615		55
12-224340		277	12-226351		453	12-228522		245	12-234097		685	14-230615		56
12-224340		368	12-226351		455	12-228522		359	12-234097		686	14-230615		57
12-224357		477	12-226351		456	12-228539		574	12-234103		337	14-230615		58
12-224357		478	12-226351		457	12-228539		575	12-234103		338	14-230615		59
12-224357		603	12-226351		458	12-228546		574	12-234110		479	14-230615		93
12-224357		604	12-226351		459	12-228546		575	12-234127		479	14-230615		97
12-224357		614	12-226368		474	12-228553		233	12-234134		484	14-230615		98
12-224364		477	12-226368		482	12-228553		238	12-234134		489	14-230615		99
12-224364		478	12-226368		483	12-228553		239	12-234141		484	14-230615		100
12-224364		603	12-226399		518	12-228553		250	12-234141		489	14-230615		101
12-224364		604	12-226399		520	12-228553		251	12-234158		474	14-230615		102
12-224364		614	12-226399		736	12-228553		359	12-234158		482	14-230615		103
12-224371		866	12-226405		231	12-228560		300	12-234158		483	14-230615		116
12-224371		867	12-226405		232	12-228560		301	12-234158		488	14-230615		119
12-224371		868	12-226405		235	12-228638		601	12-234165		474	14-230615		120
12-224371		869	12-226405		244	12-228638		605	12-234172		198	14-230615		122



# New order number – Old order number

New	Old	Page	New	Old	Page	New	Old	Page	New	Old	Page	New	Old	Page
14-230615		162	15-069153	BTE-6915	571	16-031548	PTE-3154	494	18-140651	B22-E065	431	19-019741	BNE-1974	652
14-230615		406	15-069160	BTE-6916	572	16-031548	PTE-3154	495	19-000725	BNE-H846	453	19-019741	BNE-1974	785
14-230615		421	15-069177	BTE-6917	619	16-031548	PTE-3154	496	19-000725	BNE-H846	455	19-019741	BNE-1974	787
14-230615		451	15-069177	BTE-6917	620	16-031548	PTE-3154	497	19-000725	BNE-H846	456	19-019741	BNE-1974	790
14-230615		633	15-069177	BTE-6917	621	16-031548	PTE-3154	528	19-000725	BNE-H846	457	19-019741	BNE-1974	795
14-230615		649	15-069177	BTE-6917	622	16-031548	PTE-3154	711	19-019291	BNE-1929	226	19-019741	BNE-1974	813
14-230615		650	15-100078	BTE-A007	861	16-031548	PTE-3154	714	19-019291	BNE-1929	249	19-019741	BNE-1974	857
14-230615		655	15-100078	BTE-A007	862	16-031548	PTE-3154	715	19-019291	BNE-1929	655	19-019741	BNE-1974	858
14-230615		664	15-102096	BTE-A209	104	16-031548	PTE-3154	716	19-019291	BNE-1929	688	19-019741	BNE-1974	874
14-230615		666	15-102096	BTE-A209	106	16-031548	PTE-3154	717	19-019307	BNE-1930	79	19-019758	BNE-1975	321
14-230615		668	15-104311	BTE-A431	842	16-101920	PTE-A192	104	19-019307	BNE-1930	80	19-019758	BNE-1975	510
14-230615		669	15-104311	BTE-A431	843	16-101920	PTE-A192	106	19-019307	BNE-1930	83	19-019758	BNE-1975	727
14-230615		673	15-104311	BTE-A431	845	17-047142	VTE-4714	636	19-019307	BNE-1930	84	19-019765	BNE-1976	194
14-230615		675	15-105257	BTE-A525	823	17-047142	VTE-4714	641	19-019314	BNE-1931	211	19-019765	BNE-1976	208
14-230615		774	15-105257	BTE-A525	824	17-047142	VTE-4714	651	19-019314	BNE-1931	558	19-019765	BNE-1976	556
14-230615		798	15-105257	BTE-A525	825	17-047142	VTE-4714	652	19-019314	BNE-1931	565	19-019765	BNE-1976	557
14-230615		800	15-105257	BTE-A525	850	17-047142	VTE-4714	784	19-019314	BNE-1931	571	19-019772	BNE-1977	181
14-230615		804	15-106377	BTE-A637	636	17-047142	VTE-4714	785	19-019321	BNE-1932	211	19-019772	BNE-1977	495
14-230615		806	15-106377	BTE-A637	637	17-047142	VTE-4714	786	19-019338	BNE-1933	576	19-019772	BNE-1977	529
14-230615		807	15-106377	BTE-A637	638	17-047142	VTE-4714	788	19-019345	BNE-1934	287	19-019772	BNE-1977	711
14-230615		808	15-106377	BTE-A637	641	17-047142	VTE-4714	813	19-019390	BNE-1939	235	19-019772	BNE-1977	714
14-230615		809	15-106377	BTE-A637	642	17-047142	VTE-4714	857	19-019390	BNE-1939	650	19-019772	BNE-1977	716
14-230615		812	15-106384	BTE-A638	645	17-047142	VTE-4714	874	19-019390	BNE-1939	651	19-019802	BNE-1980	104
14-230615		816	15-106384	BTE-A638	778	17-047166	VTE-4716	823	19-019406	BNE-1940	618	19-019819	BNE-1981	104
14-230615		836	15-106384	BTE-A638	843	17-047166	VTE-4716	824	19-019406	BNE-1940	619	19-019819	BNE-1981	106
14-230615		837	15-107077	BTE-A707	788	17-047166	VTE-4716	825	19-019437	BNE-1943	221	19-019819	BNE-1981	155
14-230615		838	15-107282	BTE-A728	861	17-047166	VTE-4716	850	19-019437	BNE-1943	690	19-019826	BNE-1982	2
14-230615		839	15-107664	BTE-A766	619	17-053273	VTE-5327	258	19-019437	BNE-1943	692	19-019826	BNE-1982	3
14-230615		840	15-107664	BTE-A766	620	17-053273	VTE-5327	259	19-019444	BNE-1944	176	19-019826	BNE-1982	4
14-230615		853	15-107664	BTE-A766	621	17-053273	VTE-5327	285	19-019444	BNE-1944	322	19-019826	BNE-1982	247
14-230615		856	15-107664	BTE-A766	622	17-053310	VTE-5331	198	19-019444	BNE-1944	323	19-019826	BNE-1982	248
14-230615		872	15-119469	BTE-B946	292	17-053310	VTE-5331	208	19-019444	BNE-1944	342	19-019826	BNE-1982	358
14-230615		874	15-119469	BTE-B946	293	17-053310	VTE-5331	558	19-019444	BNE-1944	491	19-019833	BNE-1983	235
14-230615		875	15-119469	BTE-B946	294	17-053310	VTE-5331	571	19-019444	BNE-1944	523	19-019833	BNE-1983	360
15-062178	BTE-6217	82	15-122582	BTE-C258	212	17-053334	VTE-5333	619	19-019444	BNE-1944	524	19-019840	BNE-1984	266
15-062185	BTE-6218	78	15-122582	BTE-C258	213	17-053334	VTE-5333	620	19-019444	BNE-1944	531	19-019840	BNE-1984	267
15-062185	BTE-6218	79	15-122582	BTE-C258	252	17-053334	VTE-5333	621	19-019444	BNE-1944	729	19-019840	BNE-1984	268
15-062185	BTE-6218	83	15-122582	BTE-C258	253	17-053334	VTE-5333	622	19-019444	BNE-1944	731	19-019864	BNE-1986	183
15-062185	BTE-6218	84	15-122582	BTE-C258	580	17-104029	VTE-A402	636	19-019444	BNE-1944	732	19-019864	BNE-1986	184
15-062192	BTE-6219	651	15-122582	BTE-C258	581	17-104029	VTE-A402	637	19-019505	BNE-1950	629	19-019864	BNE-1986	315
15-062192	BTE-6219	652	15-126191	BTE-C619	512	17-104029	VTE-A402	638	19-019505	BNE-1950	630	19-019864	BNE-1986	492
15-062192	BTE-6219	784	15-126191	BTE-C619	513	17-104029	VTE-A402	641	19-019512	BNE-1951	820	19-019864	BNE-1986	524
15-062192	BTE-6219	786	15-126191	BTE-C619	514	17-104029	VTE-A402	642	19-019529	BNE-1952	765	19-019864	BNE-1986	525
15-062192	BTE-6219	813	15-126191	BTE-C619	740	17-104029	VTE-A402	645	19-019529	BNE-1952	766	19-019864	BNE-1986	526
15-062192	BTE-6219	857	15-126191	BTE-C619	741	17-104029	VTE-A402	651	19-019536	BNE-1953	630	19-019864	BNE-1986	528
15-062192	BTE-6219	874	15-126405	BTE-C640	177	17-104029	VTE-A402	652	19-019543	BNE-1954	629	19-019864	BNE-1986	530
15-062208	BTE-6220	823	15-126405	BTE-C640	178	17-104029	VTE-A402	778	19-019543	BNE-1954	630	19-019864	BNE-1986	710
15-062208	BTE-6220	824	15-126405	BTE-C640	515	17-104029	VTE-A402	779	19-019550	BNE-1955	780	19-019864	BNE-1986	711
15-062208	BTE-6220	825	15-126405	BTE-C640	516	17-104029	VTE-A402	786	19-019550	BNE-1955	784	19-019864	BNE-1986	712
15-062208	BTE-6220	850	15-126405	BTE-C640	539	17-104029	VTE-A402	788	19-019550	BNE-1955	812	19-019864	BNE-1986	713
15-062215	BTE-6221	181	15-126405	BTE-C640	732	17-104029	VTE-A402	842	19-019550	BNE-1955	851	19-019864	BNE-1986	729
15-062215	BTE-6221	218	15-126405	BTE-C640	733	17-104029	VTE-A402	843	19-019567	BNE-1956	9	19-019864	BNE-1986	730
15-062215	BTE-6221	219	15-126405	BTE-C640	745	17-104029	VTE-A402	844	19-019567	BNE-1956	10	19-019871	BNE-1987	767
15-062215	BTE-6221	220	16-031289	PTE-3128	85	17-104029	VTE-A402	857	19-019574	BNE-1957	9	19-019888	BNE-1988	767
15-062215	BTE-6221	315	16-031289	PTE-3128	86	17-104104	VTE-A410	177	19-019574	BNE-1957	10	19-019888	BNE-1988	768
15-062215	BTE-6221	316	16-031289	PTE-3128	87	17-104104	VTE-A410	178	19-019598	BNE-1959	511	19-019888	BNE-1988	769
15-062215	BTE-6221	493	16-031289	PTE-3128	90	17-104104	VTE-A410	511	19-019598	BNE-1959	523	19-019888	BNE-1988	770
15-062215	BTE-6221	494	16-031289	PTE-3128	91	17-104104	VTE-A410	512	19-019598	BNE-1959	524	19-019888	BNE-1988	771
15-062215	BTE-6221	496	16-031296	PTE-3129	77	17-104104	VTE-A410	513	19-019598	BNE-1959	536	19-019888	BNE-1988	772
15-062215	BTE-6221	497	16-031296	PTE-3129	78	17-104104	VTE-A410	514	19-019598	BNE-1959	690	19-019895	BNE-1989	618
15-062215	BTE-6221	526	16-031296	PTE-3129	79	17-104104	VTE-A410	515	19-019598	BNE-1959	693	19-019895	BNE-1989	619
15-062215	BTE-6221	527	16-031296	PTE-3129	86	17-104104	VTE-A410	516	19-019598	BNE-1959	694	19-019901	BNE-1990	619
15-062215	BTE-6221	530	16-031296	PTE-3129	820	17-104104	VTE-A410	539	19-019598	BNE-1959	731	19-019901	BNE-1990	620
15-062215	BTE-6221	541	16-031296	PTE-3129	821	17-104104	VTE-A410	732	19-019604	BNE-1960	491	19-019901	BNE-1990	621
15-062215	BTE-6221	542	16-031296	PTE-3129	822	17-104104	VTE-A410	733	19-019604	BNE-1960	531	19-019901	BNE-1990	622
15-062215	BTE-6221	712	16-031296	PTE-3129	849	17-104104	VTE-A410	740	19-019604	BNE-1960	536	19-019932	BNE-1993	821
15-062215	BTE-6221	713	16-031296	PTE-3129	850	17-104104	VTE-A410	741	19-019604	BNE-1960	729	19-019932	BNE-1993	822
15-062215	BTE-6221	714	16-031302	PTE-3130	181	17-104104	VTE-A410	742	19-019642	BNE-1964	77	19-019932	BNE-1993	849
15-062215	BTE-6221	715	16-031302	PTE-3130	218	17-104104	VTE-A410	745	19-019642	BNE-1964	782	19-019949	BNE-1994	823
15-062215	BTE-6221	717	16-031302	PTE-3130	219	17-105248	VTE-A524	823	19-019642	BNE-1964	840	19-019949	BNE-1994	824
15-062215	BTE-6221	730	16-031302	PTE-3130	220	17-105248	VTE-A524	824	19-019642	BNE-1964	841	19-019949	BNE-1994	825
15-062215	BTE-6221	731	16-031302	PTE-3130	315	17-105248	VTE-A524	825	19-019642	BNE-1964	842	19-019949	BNE-1994	826
15-064127	BTE-6412	86	16-031302	PTE-3130	524	17-105248	VTE-A524	850	19-019659	BNE-1965	821	19-019949	BNE-1994	850
15-064462	BTE-6446	355	16-031302	PTE-3130	525	17-106405	VTE-A640	635	19-0196					



# New order number – Old order number

New	Old	Page	New	Old	Page	New	Old	Page	New	Old	Page	New	Old	Page
19-019963	BNE-1996	787	19-028811	BNE-2881	323	19-045771	VNE-4577	62	19-063423	BNE-6342	463	19-068763	BNE-6876	721
19-019963	BNE-1996	858	19-028811	BNE-2881	324	19-045771	VNE-4577	64	19-063447	BNE-6344	340	19-068855	BNE-6885	559
19-019970	BNE-1997	511	19-028811	BNE-2881	325	19-045771	VNE-4577	93	19-063447	BNE-6344	352	19-068862	BNE-6886	561
19-019970	BNE-1997	516	19-028811	BNE-2881	625	19-045771	VNE-4577	827	19-063447	BNE-6344	468	19-068879	BNE-6887	559
19-019970	BNE-1997	530	19-028835	BNE-2883	481	19-045771	VNE-4577	828	19-063447	BNE-6344	469	19-000050	BNE-A005	196
19-019970	BNE-1997	732	19-028859	BNE-2885	462	19-045771	VNE-4577	829	19-063478	BNE-6347	473	19-000050	BNE-A005	211
19-019987	BNE-1998	601	19-028873	BNE-2887	81	19-050027	VNE-5002	420	19-063478	BNE-6347	474	19-000067	BNE-A006	607
19-019987	BNE-1998	602	19-028897	BNE-2889	364	19-061054	BNE-6105	206	19-063508	BNE-6350	482	19-100180	BNE-A018	438
19-019994	BNE-1999	260	19-028897	BNE-2889	521	19-061054	BNE-6105	248	19-063560	BNE-6356	695	19-100180	BNE-A018	439
19-019994	BNE-1999	261	19-028897	BNE-2889	737	19-061054	BNE-6105	360	19-063577	BNE-6357	704	19-100180	BNE-A018	440
19-019994	BNE-1999	262	19-028903	BNE-2890	364	19-061054	BNE-6105	577	19-063584	BNE-6358	704	19-100180	BNE-A018	441
19-019994	BNE-1999	263	19-028903	BNE-2890	521	19-061061	BNE-6106	232	19-064512	BNE-6451	448	19-100180	BNE-A018	862
19-019994	BNE-1999	285	19-028903	BNE-2890	737	19-061078	BNE-6107	277	19-064512	BNE-6451	449	19-100180	BNE-A018	862
19-019994	BNE-1999	286	19-029160	BNE-2916	17	19-061078	BNE-6107	632	19-064512	BNE-6451	450	19-103044	BNE-A304	244
19-020006	BNE-2000	533	19-029177	BNE-2917	17	19-061078	BNE-6107	853	19-064529	BNE-6452	438	19-103112	BNE-A311	116
19-020006	BNE-2000	537	19-029177	BNE-2917	646	19-061085	BNE-6108	343	19-064529	BNE-6452	439	19-103112	BNE-A311	121
19-020006	BNE-2000	541	19-029177	BNE-2917	653	19-061085	BNE-6108	487	19-064529	BNE-6452	440	19-103150	BNE-A315	107
19-020006	BNE-2000	543	19-029177	BNE-2917	660	19-061085	BNE-6108	740	19-064529	BNE-6452	441	19-103150	BNE-A315	108
19-020006	BNE-2000	728	19-029177	BNE-2917	775	19-061092	BNE-6109	280	19-064529	BNE-6452	448	19-103150	BNE-A315	111
19-020006	BNE-2000	730	19-029177	BNE-2917	791	19-061092	BNE-6109	487	19-064529	BNE-6452	449	19-103150	BNE-A315	113
19-020006	BNE-2000	731	19-029177	BNE-2917	819	19-061108	BNE-6110	343	19-064529	BNE-6452	450	19-103150	BNE-A315	114
19-020006	BNE-2000	743	19-029177	BNE-2917	870	19-061108	BNE-6110	532	19-064666	BNE-6466	355	19-103150	BNE-A315	115
19-020013	BNE-2001	289	19-029177	BNE-2917	874	19-061108	BNE-6110	740	19-064666	BNE-6466	356	19-103150	BNE-A315	118
19-020013	BNE-2001	290	19-029184	BNE-2918	82	19-061115	BNE-6111	343	19-065038	BNE-6503	221	19-103150	BNE-A315	119
19-020037	BNE-2003	537	19-029207	BNE-2920	29	19-061153	BNE-6115	347	19-065038	BNE-6503	682	19-103150	BNE-A315	160
19-020037	BNE-2003	693	19-029207	BNE-2920	30	19-061153	BNE-6115	348	19-065045	BNE-6504	187	19-103471	BNE-A347	29
19-020037	BNE-2003	694	19-029214	BNE-2921	59	19-061160	BNE-6116	348	19-065045	BNE-6504	220	19-103471	BNE-A347	30
19-020068	BNE-2006	137	19-029214	BNE-2921	60	19-061177	BNE-6117	361	19-065212	BNE-6521	193	19-103471	BNE-A347	33
19-020068	BNE-2006	138	19-029214	BNE-2921	87	19-061177	BNE-6117	362	19-065212	BNE-6521	223	19-104089	BNE-A408	267
19-020068	BNE-2006	140	19-029214	BNE-2921	88	19-061177	BNE-6117	363	19-065212	BNE-6521	360	19-104089	BNE-A408	269
19-020075	BNE-2007	863	19-029214	BNE-2921	89	19-061184	BNE-6118	362	19-065212	BNE-6521	584	19-104089	BNE-A408	367
19-020075	BNE-2007	864	19-029238	BNE-2923	237	19-061184	BNE-6118	363	19-065212	BNE-6521	585	19-104089	BNE-A408	368
19-020099	BNE-2009	480	19-029238	BNE-2923	360	19-061191	BNE-6119	361	19-065236	BNE-6523	605	19-104096	BNE-A409	278
19-020105	BNE-2010	480	19-029245	BNE-2924	237	19-061191	BNE-6119	362	19-065243	BNE-6524	604	19-104300	BNE-A430	861
19-020112	BNE-2011	619	19-029245	BNE-2924	238	19-061207	BNE-6120	361	19-065601	BNE-6560	212	19-104300	BNE-A430	862
19-020129	BNE-2012	480	19-029245	BNE-2924	360	19-061207	BNE-6120	362	19-065601	BNE-6560	251	19-105369	BNE-A536	239
19-020136	BNE-2013	480	19-029252	BNE-2925	227	19-061207	BNE-6120	363	19-065601	BNE-6560	252	19-105369	BNE-A536	240
19-020143	BNE-2014	480	19-029252	BNE-2925	228	19-061238	BNE-6123	573	19-065601	BNE-6560	584	19-105369	BNE-A536	877
19-020150	BNE-2015	86	19-029252	BNE-2925	229	19-061238	BNE-6123	574	19-065618	BNE-6561	251	19-105376	BNE-A537	33
19-020150	BNE-2015	88	19-029269	BNE-2926	234	19-061245	BNE-6124	573	19-065618	BNE-6561	252	19-105895	BNE-A589	280
19-020150	BNE-2015	90	19-029269	BNE-2926	247	19-061245	BNE-6124	574	19-065625	BNE-6562	212	19-105895	BNE-A589	487
19-020150	BNE-2015	91	19-029276	BNE-2927	278	19-061252	BNE-6125	609	19-065625	BNE-6562	251	19-106120	BNE-A612	16
19-020174	BNE-2017	136	19-029283	BNE-2928	269	19-061252	BNE-6125	610	19-065625	BNE-6562	252	19-106397	BNE-A639	645
19-020174	BNE-2017	147	19-029290	BNE-2929	266	19-061269	BNE-6126	611	19-065625	BNE-6562	584	19-106397	BNE-A639	778
19-020181	BNE-2018	623	19-029290	BNE-2929	267	19-061276	BNE-6127	630	19-065632	BNE-6563	252	19-106397	BNE-A639	843
19-020198	BNE-2019	863	19-029306	BNE-2930	267	19-061276	BNE-6127	631	19-065649	BNE-6564	293	19-106625	BNE-A662	191
19-020198	BNE-2019	864	19-029306	BNE-2930	269	19-061283	BNE-6128	460	19-065649	BNE-6564	294	19-106625	BNE-A662	323
19-027531	BNE-2753	110	19-029306	BNE-2930	367	19-061283	BNE-6128	469	19-065649	BNE-6564	295	19-106625	BNE-A662	553
19-028477	BNE-2847	470	19-029306	BNE-2930	368	19-061283	BNE-6128	757	19-065656	BNE-6565	212	19-106625	BNE-A662	755
19-028477	BNE-2847	484	19-029313	BNE-2931	260	19-062730	BNE-6273	323	19-065656	BNE-6565	213	19-106632	BNE-A663	343
19-028477	BNE-2847	489	19-029313	BNE-2931	261	19-062730	BNE-6273	335	19-065656	BNE-6565	214	19-106649	BNE-A664	143
19-028477	BNE-2847	708	19-029313	BNE-2931	263	19-062747	BNE-6274	323	19-065656	BNE-6565	253	19-107141	BNE-A714	343
19-028477	BNE-2847	709	19-029313	BNE-2931	264	19-062747	BNE-6274	335	19-065656	BNE-6565	254	19-107141	BNE-A714	532
19-028484	BNE-2848	844	19-029320	BNE-2932	263	19-062778	BNE-6277	327	19-065656	BNE-6565	255	19-107141	BNE-A714	740
19-028491	BNE-2849	789	19-029320	BNE-2932	264	19-062778	BNE-6277	328	19-065656	BNE-6565	580	19-107899	BNE-A789	286
19-028514	BNE-2851	865	19-029320	BNE-2932	266	19-062778	BNE-6277	334	19-065656	BNE-6565	581	19-107899	BNE-A789	380
19-028521	BNE-2852	865	19-029337	BNE-2933	264	19-062785	BNE-6278	327	19-065656	BNE-6565	582	19-108971	BNE-A897	559
19-028538	BNE-2853	533	19-029337	BNE-2933	265	19-062785	BNE-6278	328	19-065663	BNE-6566	253	19-108971	BNE-A897	560
19-028538	BNE-2853	729	19-029344	BNE-2934	544	19-062785	BNE-6278	334	19-065681	BNE-6566	619	19-108971	BNE-A897	561
19-028545	BNE-2854	617	19-029344	BNE-2934	545	19-062792	BNE-6279	333	19-065681	BNE-6566	620	19-108988	BNE-A898	320
19-028552	BNE-2855	535	19-029344	BNE-2934	546	19-062808	BNE-6280	333	19-065681	BNE-6566	621	19-108988	BNE-A898	517
19-028552	BNE-2855	743	19-029344	BNE-2934	746	19-062815	BNE-6281	333	19-065681	BNE-6566	622	19-108988	BNE-A898	540
19-028569	BNE-2856	477	19-029344	BNE-2934	747	19-062822	BNE-6282	333	19-065687	BNE-6567	270	19-108988	BNE-A898	734
19-028576	BNE-2857	230	19-029368	BNE-2936	572	19-062853	BNE-6285	323	19-065687	BNE-6567	271	19-108988	BNE-A898	735
19-028613	BNE-2861	534	19-029375	BNE-2937	623	19-062853	BNE-6285	324	19-065687	BNE-6567	272	19-108988	BNE-A898	745
19-028613	BNE-2861	742	19-029382	BNE-2938	631	19-062853	BNE-6285	325	19-067346	BNE-6734	141	19-108995	BNE-A899	320
19-028620	BNE-2862	481	19-029399	BNE-2939	641	19-062853	BNE-6285	625	19-067803	BNE-6780	635	19-108995	BNE-A899	517
19-028620	BNE-2862	482	19-029405	BNE-2940	659	19-062860	BNE-6286	323	19-067803	BNE-6780	818	19-108995	BNE-A899	540
19-028637	BNE-2863	150	19-029412	BNE-2941	659	19-062860	BNE-6286	324	19-067834	BNE-6783	471	19-108995	BNE-A899	734
19-028651	BNE-2865	636	19-029412	BNE-2941	660	19-062860	BNE-6286	325	19-067971	BNE-6797	675	19-108995	BNE-A899	735
19-028651	BNE-2865	637	19-029429	BNE-2942	646	19-062860	BNE-6286	625	19-067971	BNE-6797	676	19-108995	BNE-A899	745
19-028651	BNE-2865	638	19-029429	BNE-2942	653	19-062860	BNE-6286	626	19-068022	BNE-6802	207	19-109299	BNE-A929	566
19-0														



# New order number – Old order number

New	Old	Page	New	Old	Page	New	Old	Page	New	Old	Page	New	Old	Page
19-111728	BNE-B172	606	19-127439	BNE-C743	632	19-140032	BNE-E003	793	19-146980	BNE-E698	521	19-164687	BNE-G468	705
19-111780	BNE-B178	268	19-127439	BNE-C743	634	19-140032	BNE-E003	819	19-146980	BNE-E698	737	19-164786	BNE-G478	296
19-111780	BNE-B178	368	19-127439	BNE-C743	647	19-140032	BNE-E003	870	19-147024	BNE-E702	699	19-164786	BNE-G478	298
19-111797	BNE-B179	38	19-127439	BNE-C743	654	19-140032	BNE-E003	875	19-147024	BNE-E702	700	19-164786	BNE-G478	299
19-111797	BNE-B179	41	19-127439	BNE-C743	663	19-140032	BNE-E003	876	19-147093	BNE-E709	628	19-164915	BNE-G491	782
19-111797	BNE-B179	43	19-127439	BNE-C743	665	19-140049	BNE-E004	62	19-147291	BNE-E729	275	19-165349	BNE-G534	466
19-111803	BNE-B180	38	19-127439	BNE-C743	674	19-140049	BNE-E004	64	19-147291	BNE-E729	761	19-165479	BNE-G547	334
19-111803	BNE-B180	41	19-127439	BNE-C743	795	19-140049	BNE-E004	93	19-147659	BNE-E765	198	19-165486	BNE-G548	334
19-111803	BNE-B180	43	19-127439	BNE-C743	796	19-140049	BNE-E004	827	19-147659	BNE-E765	557	19-165530	BNE-G553	296
19-112763	BNE-B276	277	19-127439	BNE-C743	814	19-140049	BNE-E004	831	19-147659	BNE-E765	689	19-165530	BNE-G553	298
19-112862	BNE-B286	377	19-127439	BNE-C743	815	19-140049	BNE-E004	833	19-148519	BNE-E851	183	19-165530	BNE-G553	299
19-112862	BNE-B286	378	19-127439	BNE-C743	816	19-140056	BNE-E005	544	19-148519	BNE-E851	531	19-165547	BNE-G554	231
19-112893	BNE-B289	372	19-127439	BNE-C743	852	19-140056	BNE-E005	545	19-148519	BNE-E851	739	19-165547	BNE-G554	232
19-112893	BNE-B289	373	19-127439	BNE-C743	870	19-140056	BNE-E005	546	19-151069	BNE-F106	672	19-165554	BNE-G555	327
19-112893	BNE-B289	374	19-127439	BNE-C743	872	19-140056	BNE-E005	746	19-151069	BNE-F106	673	19-165646	BNE-G564	326
19-112893	BNE-B289	382	19-127439	BNE-C743	875	19-140056	BNE-E005	747	19-151069	BNE-F106	810	19-165697	BNE-G596	226
19-113128	BNE-B312	201	19-127439	BNE-C743	876	19-140056	BNE-E005	748	19-151069	BNE-F106	835	19-165998	BNE-G599	280
19-113128	BNE-B312	202	19-128146	BNE-C814	349	19-140087	BNE-E008	168	19-151069	BNE-F106	836	19-165998	BNE-G599	382
19-113128	BNE-B312	203	19-128153	BNE-C815	349	19-140087	BNE-E008	627	19-151069	BNE-F106	837	19-166278	BNE-G627	462
19-113128	BNE-B312	568	19-128160	BNE-C816	338	19-140100	BNE-E010	866	19-151069	BNE-F106	838	19-166278	BNE-G627	677
19-113135	BNE-B313	569	19-128177	BNE-C817	338	19-140100	BNE-E010	867	19-151069	BNE-F106	839	19-166384	BNE-G638	217
19-113135	BNE-B313	570	19-128191	BNE-C819	605	19-140100	BNE-E010	868	19-151069	BNE-F106	840	19-166384	BNE-G638	615
19-115351	BNE-B535	183	19-128238	BNE-C823	205	19-140100	BNE-E010	869	19-151069	BNE-F106	875	19-166445	BNE-G644	479
19-115351	BNE-B535	512	19-128238	BNE-C823	248	19-140391	BNE-E039	216	19-151083	BNE-F108	672	19-166452	BNE-G645	688
19-115351	BNE-B535	518	19-128238	BNE-C823	359	19-140391	BNE-E039	356	19-151083	BNE-F108	673	19-166766	BNE-G676	326
19-115351	BNE-B535	531	19-128238	BNE-C823	577	19-140391	BNE-E039	366	19-151083	BNE-F108	835	19-167046	BNE-G704	477
19-115351	BNE-B535	732	19-128269	BNE-C826	576	19-140391	BNE-E039	609	19-151083	BNE-F108	836	19-167060	BNE-G706	603
19-115351	BNE-B535	739	19-128290	BNE-C829	235	19-140407	BNE-E040	218	19-151083	BNE-F108	837	19-167084	BNE-G708	614
19-118703	BNE-B870	757	19-128863	BNE-C886	842	19-140407	BNE-E040	219	19-151083	BNE-F108	838	19-167367	BNE-G736	479
19-118758	BNE-B875	164	19-128863	BNE-C886	845	19-140407	BNE-E040	677	19-151083	BNE-F108	839	19-167985	BNE-G798	442
19-118758	BNE-B875	166	19-131689	BNE-D168	554	19-140414	BNE-E041	218	19-151083	BNE-F108	840	19-167985	BNE-G798	443
19-118758	BNE-B875	167	19-131689	BNE-D168	555	19-140414	BNE-E041	219	19-151083	BNE-F108	875	19-167985	BNE-G798	862
19-118758	BNE-B875	231	19-131689	BNE-D168	624	19-140414	BNE-E041	677	19-151113	BNE-F111	705	19-168203	BNE-G820	618
19-118758	BNE-B875	539	19-131689	BNE-D168	740	19-140605	BNE-E060	246	19-151793	BNE-F179	339	19-168210	BNE-G821	688
19-118758	BNE-B875	547	19-131702	BNE-D170	554	19-141619	BNE-E161	317	19-152608	BNE-F260	351	19-168210	BNE-G821	700
19-118758	BNE-B875	549	19-131702	BNE-D170	624	19-141619	BNE-E161	318	19-152615	BNE-F261	489	19-168388	BNE-G838	365
19-118758	BNE-B875	551	19-131702	BNE-D170	740	19-141619	BNE-E161	319	19-152615	BNE-F261	555	19-168432	BNE-G843	704
19-118758	BNE-B875	552	19-132327	BNE-D232	265	19-141619	BNE-E161	503	19-152615	BNE-F261	623	19-168487	BNE-G848	683
19-118758	BNE-B875	744	19-132327	BNE-D232	266	19-141619	BNE-E161	504	19-152615	BNE-F261	624	19-168494	BNE-G849	683
19-118758	BNE-B875	749	19-132334	BNE-D233	2	19-141619	BNE-E161	505	19-152615	BNE-F261	754	19-168685	BNE-G868	209
19-118758	BNE-B875	750	19-132334	BNE-D233	3	19-141619	BNE-E161	723	19-152646	BNE-F264	354	19-168685	BNE-G868	210
19-118758	BNE-B875	751	19-132334	BNE-D233	4	19-141619	BNE-E161	724	19-152769	BNE-F276	99	19-168784	BNE-G878	490
19-118758	BNE-B875	753	19-132341	BNE-D234	143	19-141619	BNE-E161	725	19-152769	BNE-F276	100	19-168784	BNE-G878	680
19-119205	BNE-B920	453	19-132471	BNE-D247	4	19-141626	BNE-E162	191	19-152790	BNE-F279	99	19-168784	BNE-G878	683
19-119205	BNE-B920	454	19-132495	BNE-D249	286	19-141626	BNE-E162	318	19-152790	BNE-F279	100	19-168784	BNE-G878	687
19-119328	BNE-B932	235	19-132495	BNE-D249	380	19-141626	BNE-E162	507	19-153681	BNE-F368	353	19-168784	BNE-G878	710
19-119328	BNE-B932	244	19-132501	BNE-D250	432	19-141626	BNE-E162	508	19-155876	BNE-F587	615	19-169163	BNE-G916	447
19-119328	BNE-B932	257	19-132792	BNE-D279	554	19-141626	BNE-E162	553	19-155876	BNE-F587	616	19-169163	BNE-G916	448
19-119519	BNE-B951	272	19-132792	BNE-D279	555	19-141626	BNE-E162	554	19-156316	BNE-F631	465	19-169163	BNE-G916	860
19-119519	BNE-B951	273	19-132792	BNE-D279	624	19-141626	BNE-E162	726	19-156545	BNE-F654	367	19-169163	BNE-G916	861
19-119526	BNE-B952	273	19-132792	BNE-D279	740	19-141626	BNE-E162	755	19-156545	BNE-F654	490	19-169200	BNE-G920	8
19-119526	BNE-B952	274	19-135021	BNE-D502	123	19-142128	BNE-E212	468	19-156545	BNE-F654	684	19-169200	BNE-G920	10
19-119526	BNE-B952	302	19-135021	BNE-D502	126	19-142135	BNE-E213	468	19-156545	BNE-F654	686	19-169200	BNE-G920	12
19-119526	BNE-B952	756	19-135021	BNE-D502	128	19-142142	BNE-E214	325	19-156545	BNE-F654	687	19-169262	BNE-G926	171
19-119526	BNE-B952	758	19-135021	BNE-D502	160	19-142142	BNE-E214	326	19-156545	BNE-F654	710	19-169262	BNE-G926	182
19-119526	BNE-B952	772	19-135052	BNE-D505	14	19-142142	BNE-E214	327	19-156699	BNE-F669	783	19-169262	BNE-G926	218
19-119922	BNE-B992	29	19-135052	BNE-D505	15	19-142173	BNE-E217	222	19-158150	BNE-F815	707	19-169279	BNE-G927	444
19-119922	BNE-B992	33	19-135052	BNE-D505	123	19-142241	BNE-E224	467	19-158150	BNE-F815	708	19-169279	BNE-G927	445
19-119922	BNE-B992	831	19-135052	BNE-D505	126	19-142258	BNE-E225	467	19-158198	BNE-F819	478	19-169279	BNE-G927	446
19-119922	BNE-B992	833	19-135052	BNE-D505	161	19-142265	BNE-E226	236	19-158464	BNE-F846	380	19-169279	BNE-G927	447
19-119939	BNE-B993	30	19-135069	BNE-D506	184	19-142449	BNE-E244	779	19-158495	BNE-F849	240	19-169279	BNE-G927	859
19-119939	BNE-B993	33	19-135069	BNE-D506	356	19-142449	BNE-E244	780	19-158495	BNE-F849	241	19-169279	BNE-G927	860
19-119939	BNE-B993	62	19-135076	BNE-D507	184	19-142913	BNE-E291	325	19-158495	BNE-F849	242	19-169279	BNE-G927	861
19-119939	BNE-B993	64	19-135076	BNE-D507	356	19-142913	BNE-E291	326	19-158495	BNE-F849	519	19-169538	BNE-G953	8
19-119939	BNE-B993	93	19-135083	BNE-D508	333	19-142913	BNE-E291	327	19-158495	BNE-F849	520	19-169538	BNE-G953	10
19-119939	BNE-B993	671	19-135090	BNE-D509	333	19-143026	BNE-E302	216	19-158495	BNE-F849	736	19-169538	BNE-G953	12
19-119939	BNE-B993	827	19-135106	BNE-D510	207	19-143026	BNE-E302	217	19-158686	BNE-F868	681	19-169965	BNE-G996	353
19-119939	BNE-B993	828	19-135106	BNE-D510	243	19-143026	BNE-E302	356	19-158693	BNE-F869	233	19-170084	BNE-H008	75
19-119939	BNE-B993	829	19-135106	BNE-D510	578	19-143026	BNE-E302	609	19-158693	BNE-F869	359	19-170084	BNE-H008	76
19-119939	BNE-B993	831	19-135106	BNE-D510	579	19-144221	BNE-E422	96	19-158761	BNE-F876	335	19-170206	BNE-H020	278
19-119939	BNE-B993	833	19-135113	BNE-D511	611	19-144221	BNE-E422	98	19-158778	BNE-F877	703	19-170206	BNE-H020	283
19-121369	BNE-C136	337	19-135113	BNE-D511	612	19-144238	BNE-E423	96	19-158785	BNE-F878	703	19-170206	BNE-H020	284
19-122472	BNE-C247	216	19-135113	BNE-D511	613	19-144238	BNE-E423	98	19-158839	BNE-F883	155	19-170206	BNE-H020	291
19-122472	BNE-C247	366	19-135304	BNE-D530	312	19-144948	BNE-E494	331	19-158839	BNE-F883	156	19-170206	BNE-H020	302
19-122472	BNE-C247	609	19-135311	BNE-D531	312	19-144948</								

# New order number – Old order number



New	Old	Page	New	Old	Page	New	Old	Page	New	Old	Page	New	Old	Page
19-171586	BNE-H158	455	19-183916		157	19-214276		470	19-225289		207	19-232065		518
19-171586	BNE-H158	456	19-184050	BNE-H837	30	19-214320		123	19-225289		243	19-232157		667
19-171586	BNE-H158	457	19-184050	BNE-H837	33	19-214320		128	19-225289		579	19-232157		668
19-171593	BNE-H159	52	19-184067	BNE-H887	62	19-214405		365	19-226323		773	19-232157		807
19-171593	BNE-H159	54	19-184067	BNE-H887	64	19-214405		365	19-226323		774	19-232157		809
19-171593	BNE-H159	56	19-184074	BNE-H817	154	19-214481		341	19-226330		773	19-232430		205
19-171593	BNE-H159	57	19-184081	BNE-H816	154	19-214498		341	19-226330		774	19-232485		206
19-171593	BNE-H159	58	19-184098	BNE-H818	154	19-214634		354	19-226392		484	19-232515		491
19-171593	BNE-H159	72	19-184104		250	19-214641		610	19-226392		489	19-232546		488
19-171593	BNE-H159	92	19-184104		251	19-214658	BNE-G746	625	19-226491		476	19-232546		489
19-171593	BNE-H159	94	19-184128		341	19-215693		704	19-226651		17	19-232546		555
19-171609	BNE-H160	52	19-184135		341	19-215976		453	19-226705		203	19-232546		624
19-171609	BNE-H160	54	19-184142		467	19-215976		456	19-226736		197	19-232546		625
19-171609	BNE-H160	56	19-189291		207	19-215976		457	19-226736		198	19-232553		488
19-171609	BNE-H160	57	19-189291		233	19-215983		453	19-226736		578	19-232553		489
19-171609	BNE-H160	58	19-189291		242	19-215983		456	19-226736		580	19-232553		555
19-171609	BNE-H160	72	19-189291		578	19-215983		457	19-226743		197	19-232553		624
19-171609	BNE-H160	92	19-189666	VN3-H554	855	19-215990		455	19-226743		580	19-232553		625
19-171609	BNE-H160	94	19-189673	VN3-H555	855	19-215990		456	19-226750		198	19-232638		760
19-171616	BNE-H161	52	19-189680	VN3-H556	855	19-215990		457	19-226750		580	19-232690		246
19-171616	BNE-H161	54	19-189697	VN3-H011	855	19-215990		458	19-226798		215	19-232812		217
19-171616	BNE-H161	56	19-189703	VN3-H012	855	19-215990		459	19-226798		255	19-232812		615
19-171616	BNE-H161	57	19-189710	VN3-G617	855	19-216003		455	19-226798		256	19-232928		578
19-171616	BNE-H161	58	19-193298		146	19-216003		456	19-226798		583	19-233734		165
19-171616	BNE-H161	92	19-193298		147	19-216003		457	19-226798		584	19-233734		190
19-171623	BNE-H162	52	19-193298		162	19-216003		458	19-226859		55	19-233734		532
19-171623	BNE-H162	54	19-193304		146	19-216003		459	19-226866		55	19-233734		739
19-171623	BNE-H162	56	19-193304		147	19-216942		235	19-226880		69	19-233765		165
19-171623	BNE-H162	57	19-193304		162	19-216966		864	19-226880		70	19-233765		191
19-171623	BNE-H162	58	19-193311		146	19-216973		823	19-226880		94	19-233765		532
19-171623	BNE-H162	92	19-193311		162	19-216973		825	19-226897		69	19-233765		740
19-171814	BNE-H181	300	19-193328		147	19-216980		361	19-226897		70	19-234656		153
19-171814	BNE-H181	301	19-193359		626	19-217000		361	19-226897		94	19-235042		216
19-171814	BNE-H181	302	19-193441		200	19-217154		273	19-226903		69	19-235042		604
19-172644	BNE-H264	296	19-193441		205	19-217154		276	19-226903		70	19-235219		422
19-172644	BNE-H264	298	19-193465		613	19-217161		277	19-226903		94	19-235370		217
19-172644	BNE-H264	299	19-193465		614	19-217451	BNE-D997	209	19-226910		69	19-235370		615
19-172651	BNE-H265	296	19-193472		571	19-217468		864	19-226910		70	19-235448		198
19-172651	BNE-H265	298	19-193564	BNE-G112	347	19-217994		100	19-226910		94	19-235448		557
19-172651	BNE-H265	300	19-194172		570	19-217994		102	19-227054		233	19-235448		689
19-172682	BNE-H268	198	19-194448		72	19-218014		100	19-227085		232	19-235479		198
19-172682	BNE-H268	466	19-194455		72	19-218014		102	19-227085		512	19-235479		557
19-172682	BNE-H268	577	19-194462		599	19-218458		339	19-227566		286	19-235479		689
19-172743	BNE-H274	151	19-194462		855	19-218625		362	19-227573		286	19-235486		204
19-172859	BNE-H285	11	19-194479		599	19-218625		363	19-227627		148	19-235493		204
19-172903	BNE-H290	478	19-194479		855	19-218632		362	19-227634		148	19-235509		204
19-172903	BNE-H290	479	19-194486		599	19-218632		363	19-227641		148	19-235516		204
19-172903	BNE-H290	488	19-194486		855	19-218717		361	19-227641		149	19-235547		236
19-172910	BNE-H291	478	19-194493		204	19-218717		362	19-227696		222	19-235585		236
19-172910	BNE-H291	479	19-194509		204	19-218724		361	19-227740		379	19-235646		236
19-172910	BNE-H291	488	19-194523		183	19-218724		362	19-227771		380	19-235677		236
19-172996	BNE-H299	26	19-194875		599	19-218731		361	19-227801		463	19-235707		236
19-172996	BNE-H299	806	19-194882		599	19-218748		361	19-227832		463	19-235738		236
19-173177	BNE-H317	467	19-194899		599	19-218939		151	19-227856		468	19-235769		291
19-173559	BNE-H355	354	19-195322		10	19-219073		701	19-227863		470	19-235790		291
19-173580	BNE-H358	333	19-195322		224	19-219080		699	19-227870		470	19-235837		334
19-174204	BNE-H420	483	19-195322		257	19-219080		700	19-227887		471	19-235868		334
19-174204	BNE-H420	484	19-195339		146	19-219097		377	19-227894		471	19-235905		339
19-174211	BNE-H421	335	19-195346		146	19-219097		378	19-227900		471	19-235936		339
19-181424	BNE-6296	336	19-195353		146	19-219103		377	19-227917		471	19-235974		351
19-182841		279	19-196299		278	19-219103		378	19-227924		471	19-235974		352
19-183398		214	19-196299		279	19-219127		354	19-227931		613	19-236001		351
19-183398		215	19-196299		291	19-219134		354	19-227948		709	19-236001		352
19-183398		255	19-196312		656	19-219158		689	19-227955		709	19-236087		617
19-183398		256	19-196312		657	19-219189		72	19-227955		709	19-236087		617
19-183398		583	19-196350		339	19-219592		785	19-229096		577	19-236100		617
19-183398		584	19-196671		704	19-220079		131	19-229355		217	19-236155		478
19-183459		340	19-196862		632	19-220079		133	19-229409		190	19-236186		478
19-183473		340	19-196862		854	19-220079		134	19-229409		532	19-236223		532
19-183510		341	19-196893		704	19-220079		161	19-229409		739	19-236223		739
19-183534		341	19-197135		351	19-220079		161	19-229416		165	19-236254		532
19-183558		339	19-197135		352	19-220093		131	19-229416		190	19-236254		739
19-183565		339	19-197210		236	19-220093		134	19-229416		532	19-236285		707
19-183572		339	19-197227		236	19-220093		161	19-229416		739	19-236315		708
19-183633		165	19-197227		279	19-220567		773	19-229447		707	19-236513		212
19-183633		166	19-197302		374	19-220598		115	19-229492		682	19-236681		478
19-183633		180	19-197692		153	19-220598		118	19-229492		707	19-236681		478
19-183633		191	19-197791		477	19-220598		121	19-229522		682	19-236971		670
19-183633		321	19-199511		118	19-220970		147	19-229539		682	19-236971		671
19-183633		322	19-199511		119	19-220970		148	19-229539		682	19-238784		196
19-183633		509	19-212647		469	19-221427		327	19-229584		682	19-238784		197
19-183633		510	19-212722		144	19-221519		341	19-229614		704	19-238784		579
19-183633		554	19-213156		154	19-221694		626	19-230221		149	19-238784		580
19-183633		726	19-213729		457	19-221700		626	19-230238		149	19-238791		192
19-183633		727	19-213729		459	19-222073		651	19-230542		667	19-238791		230
19-183633		755	19-213736		457	19-222073		655	19-230542		668	19-238791		245
19-183664		166	19-213736		459	19-222073		856	19-230542		807	19-239828		146



# New order number – Old order number

New	Old	Page	New	Old	Page	New	Old	Page	New	Old	Page	New	Old	Page
20-070816	BA5-7081	345	21-030444	PNE-3044	81	22-003799	V36-0379	111	22-040909	VNE-4090	514	22-042552	VN7-4255	237
20-070823	BA5-7082	345	21-030444	PNE-3044	82	22-003805	V36-0380	108	22-040909	VNE-4090	515	22-042552	VN7-4255	238
20-070830	BA5-7083	345	21-030444	PNE-3044	83	22-003805	V36-0380	111	22-040909	VNE-4090	516	22-042569	VN7-4256	237
20-070847	BA5-7084	345	21-030444	PNE-3044	84	22-003812	V36-0381	108	22-040909	VNE-4090	518	22-042750	VN7-4275	227
20-070854	BA5-7085	344	21-030468	PNE-3046	785	22-003812	V36-0381	111	22-040909	VNE-4090	540	22-042767	VN7-4276	227
20-070861	BA3-7086	422	21-030468	PNE-3046	813	22-003829	V36-0382	108	22-040909	VNE-4090	732	22-043016	VN3-4301	229
20-070878	BA3-7087	422	21-030468	PNE-3046	874	22-003829	V36-0382	111	22-040909	VNE-4090	733	22-043023	VN3-4302	229
20-070885	BA5-7088	344	21-030475	PNE-3047	194	22-004062	V36-0406	824	22-040909	VNE-4090	740	22-043085	VN3-4308	824
20-070915	BA5-7091	420	21-030475	PNE-3047	208	22-004062	V36-0406	826	22-040909	VNE-4090	741	22-043085	VN3-4308	826
20-101893	BA3-A189	420	21-030475	PNE-3047	556	22-004062	V36-0406	851	22-040909	VNE-4090	742	22-043085	VN3-4308	851
20-101893	BA3-A189	451	21-030475	PNE-3047	557	22-031167	PNE-3116	29	22-040909	VNE-4090	745	22-043092	VN3-4309	824
20-109097	BA3-A909	406	21-030499	PNE-3049	104	22-031167	PNE-3116	30	22-040916	VNE-4091	198	22-043092	VN3-4309	826
20-114411	BA5-B441	346	21-030499	PNE-3049	106	22-031167	PNE-3116	33	22-040916	VNE-4091	209	22-043092	VN3-4309	850
20-114428	BA5-B442	346	21-030505	PNE-3050	104	22-031167	PNE-3116	62	22-040916	VNE-4091	558	22-043092	VN3-4309	851
20-114435	BA5-B443	346	21-030505	PNE-3050	106	22-031167	PNE-3116	64	22-040916	VNE-4091	571	22-043313	VN7-4331	267
20-114497	BA5-B449	345	21-030505	PNE-3050	155	22-031167	PNE-3116	93	22-040923	VNE-4092	640	22-043313	VN7-4331	286
20-114503	BA5-B450	345	21-030512	PNE-3051	136	22-031167	PNE-3116	827	22-040923	VNE-4092	650	22-043320	VN7-4332	279
20-114510	BA5-B451	346	21-030512	PNE-3051	147	22-031167	PNE-3116	828	22-040923	VNE-4092	651	22-043337	VN7-4333	286
20-114527	BA5-B452	346	21-030529	PNE-3052	321	22-031204	PNE-3120	533	22-040930	VNE-4093	242	22-043344	VN7-4334	115
20-146078	BA5-E607	364	21-030529	PNE-3052	510	22-031204	PNE-3120	537	22-040930	VNE-4093	243	22-043344	VN7-4334	118
20-146085	BA5-G650	364	21-030529	PNE-3052	541	22-031204	PNE-3120	728	22-040954	VNE-4095	266	22-043344	VN7-4334	120
20-146092	BA5-G651	364	21-030529	PNE-3052	543	22-031204	PNE-3120	729	22-040961	VNE-4096	288	22-043344	VN7-4334	121
21-030246	PNE-3024	137	21-030529	PNE-3052	727	22-031204	PNE-3120	743	22-040961	VNE-4096	289	22-043351	VN7-4335	115
21-030246	PNE-3024	138	21-030529	PNE-3052	730	22-040039	V36-4003	247	22-040992	VNE-4099	227	22-043351	VN7-4335	118
21-030253	PNE-3025	137	21-030529	PNE-3052	731	22-040039	V36-4003	248	22-040992	VNE-4099	229	22-043351	VN7-4335	120
21-030260	PNE-3026	315	21-030536	PNE-3053	768	22-040039	V36-4003	358	22-041005	VNE-4100	247	22-043351	VN7-4335	121
21-030260	PNE-3026	316	21-030543	PNE-3054	767	22-040046	V36-4004	211	22-041005	VNE-4100	248	22-043375	VN7-4337	609
21-030260	PNE-3026	493	21-030543	PNE-3054	768	22-040053	V36-4005	211	22-041012	VNE-4101	266	22-043375	VN7-4337	610
21-030260	PNE-3026	494	21-030543	PNE-3054	769	22-040077	V36-4007	108	22-041012	VNE-4101	268	22-043375	VN7-4337	611
21-030260	PNE-3026	495	21-030543	PNE-3054	770	22-040077	V36-4007	110	22-041029	VNE-4102	288	22-043542	VN7-4354	264
21-030260	PNE-3026	496	21-030543	PNE-3054	771	22-040077	V36-4007	111	22-041029	VNE-4102	289	22-043542	VN7-4354	265
21-030260	PNE-3026	497	21-030543	PNE-3054	772	22-040077	V36-4007	113	22-041029	VNE-4102	290	22-043559	VN7-4355	279
21-030260	PNE-3026	714	21-030550	PNE-3055	357	22-040084	V36-4008	108	22-041043	VNE-4104	208	22-043696	VN7-4369	611
21-030260	PNE-3026	715	21-030567	PNE-3056	690	22-040084	V36-4008	110	22-041043	VNE-4104	209	22-043825	VN7-4382	264
21-030260	PNE-3026	716	21-030567	PNE-3056	692	22-040084	V36-4008	111	22-041043	VNE-4104	558	22-043825	VN7-4382	265
21-030260	PNE-3026	717	21-030567	PNE-3056	693	22-040084	V36-4008	113	22-041043	VNE-4104	571	22-043832	VN7-4383	116
21-030314	PNE-3031	765	21-031090	PNE-3109	690	22-040213	V36-4021	211	22-041050	VNE-4105	208	22-043832	VN7-4383	117
21-030314	PNE-3031	766	21-031120	PNE-3112	150	22-040220	V36-4022	211	22-041050	VNE-4105	209	22-043832	VN7-4383	118
21-030338	PNE-3033	778	21-031137	PNE-3113	150	22-040251	V36-4025	620	22-041050	VNE-4105	558	22-043832	VN7-4383	120
21-030338	PNE-3033	784	21-031144	PNE-3114	150	22-040251	V36-4025	621	22-041050	VNE-4105	571	22-043849	VN7-4384	116
21-030338	PNE-3033	812	21-031182	PNE-3118	137	22-040251	V36-4025	622	22-041067	VNE-4106	767	22-043849	VN7-4384	117
21-030338	PNE-3033	851	21-031182	PNE-3118	138	22-040251	V36-4025	623	22-041081	VNE-4108	619	22-043849	VN7-4384	118
21-030345	PNE-3034	77	21-031182	PNE-3118	140	22-040374	V36-4037	2	22-041081	VNE-4108	620	22-043849	VN7-4384	120
21-030345	PNE-3034	782	21-031199	PNE-3119	137	22-040374	V36-4037	3	22-041081	VNE-4108	621	22-044099	VN2-4409	383
21-030345	PNE-3034	840	21-031199	PNE-3119	138	22-040374	V36-4037	4	22-041081	VNE-4108	622	22-044105	VN2-4410	384
21-030345	PNE-3034	841	21-031199	PNE-3119	140	22-040381	V36-4038	2	22-041128	VNE-4112	601	22-044150	VNE-4415	107
21-030345	PNE-3034	842	21-031267	PNE-3126	630	22-040381	V36-4038	3	22-041135	VNE-4113	260	22-044150	VNE-4415	111
21-030376	PNE-3037	511	21-031274	PNE-3127	631	22-040381	V36-4038	4	22-041135	VNE-4113	261	22-044167	VNE-4416	107
21-030376	PNE-3037	532	21-031359	PNE-3135	695	22-040398	V36-4039	247	22-041135	VNE-4113	262	22-044167	VNE-4416	111
21-030376	PNE-3037	537	21-031359	PNE-3135	696	22-040398	V36-4039	248	22-041135	VNE-4113	265	22-044174	VNE-4417	108
21-030376	PNE-3037	728	21-031366	PNE-3136	690	22-040398	V36-4039	358	22-041135	VNE-4113	266	22-044174	VNE-4417	111
21-030376	PNE-3037	743	21-031366	PNE-3136	691	22-040534	V36-4053	407	22-041135	VNE-4113	285	22-044181	VNE-4418	108
21-030376	PNE-3037	754	21-031373	PNE-3137	695	22-040534	V36-4053	408	22-041142	VNE-4114	636	22-044181	VNE-4418	111
21-030383	PNE-3038	693	21-031373	PNE-3137	696	22-040534	V36-4053	409	22-041142	VNE-4114	641	22-044198	VNE-4419	108
21-030383	PNE-3038	694	21-031380	PNE-3138	695	22-040534	V36-4053	412	22-041142	VNE-4114	652	22-044198	VNE-4419	110
21-030390	PNE-3039	59	21-031380	PNE-3138	696	22-040534	V36-4053	413	22-041142	VNE-4114	785	22-044198	VNE-4419	111
21-030390	PNE-3039	60	21-031397	PNE-3139	690	22-040534	V36-4053	414	22-041142	VNE-4114	787	22-044198	VNE-4419	113
21-030390	PNE-3039	70	21-031397	PNE-3139	691	22-040589	V36-4058	824	22-041142	VNE-4114	789	22-044198	VNE-4419	114
21-030390	PNE-3039	85	21-031410	PNE-3141	691	22-040589	V36-4058	826	22-041142	VNE-4114	813	22-044204	VNE-4420	108
21-030390	PNE-3039	86	21-031410	PNE-3141	692	22-040589	V36-4058	850	22-041142	VNE-4114	857	22-044204	VNE-4420	110
21-030390	PNE-3039	87	21-031434	PNE-3143	693	22-040589	V36-4058	851	22-041142	VNE-4114	874	22-044204	VNE-4420	111
21-030390	PNE-3039	88	21-031441	PNE-3144	476	22-040657	VNE-4065	211	22-041159	VNE-4115	260	22-044204	VNE-4420	113
21-030390	PNE-3039	89	21-031465	PNE-3146	355	22-040657	VNE-4065	565	22-041159	VNE-4115	261	22-044204	VNE-4420	114
21-030390	PNE-3039	90	21-031502	PNE-3150	823	22-040657	VNE-4065	566	22-041159	VNE-4115	262	22-044389	VN3-4438	141
21-030390	PNE-3039	91	21-031502	PNE-3150	824	22-040657	VNE-4065	567	22-041159	VNE-4115	263	22-044389	VN3-4438	143
21-030406	PNE-3040	77	21-031502	PNE-3150	825	22-040664	VNE-4066	211	22-041159	VNE-4115	265	22-044587	VNE-4458	690
21-030406	PNE-3040	78	21-031502	PNE-3150	851	22-040664	VNE-4066	565	22-041159	VNE-4115	266	22-044761	VNE-4476	635
21-030406	PNE-3040	79	21-031519	PNE-3151	471	22-040664	VNE-4066	566	22-041159	VNE-4115	285	22-044761	VNE-4476	645
21-030406	PNE-3040	83	21-216381		104	22-040664	VNE-4066	567	22-041159	VNE-4115	286	22-044761	VNE-4476	652
21-030406	PNE-3040	820	21-216381		106	22-040671	VNE-4067	211	22-041166	VNE-4116	601	22-044761	VNE-4476	778
21-030406	PNE-3040	821	22-001856	V36-0185	407	22-040688	VNE-4068	211	22-041173	VNE-4117	249	22-044761	VNE-4476	779
21-030406	PNE-3040	822	22-00185											



# New order number – Old order number

New	Old	Page	New	Old	Page	New	Old	Page	New	Old	Page	New	Old	Page
22-045010	VNE-4501	858	22-045768	VNE-4576	824	22-047601	VNE-4760	375	22-049254	VNE-4925	481	22-053077	VNE-5307	316
22-045027	VNE-4502	636	22-045768	VNE-4576	825	22-047625	VNE-4762	376	22-049261	VNE-4926	481	22-053077	VNE-5307	317
22-045027	VNE-4502	638	22-045768	VNE-4576	826	22-047625	VNE-4762	381	22-049285	VNE-4928	681	22-053077	VNE-5307	319
22-045027	VNE-4502	641	22-045768	VNE-4576	850	22-047632	VNE-4763	376	22-049315	VNE-4931	681	22-053077	VNE-5307	498
22-045027	VNE-4502	652	22-045768	VNE-4576	851	22-047632	VNE-4763	377	22-049322	VNE-4932	681	22-053077	VNE-5307	499
22-045027	VNE-4502	781	22-045874	VNE-4587	544	22-047649	VNE-4764	376	22-049339	VNE-4933	681	22-053077	VNE-5307	501
22-045027	VNE-4502	787	22-045874	VNE-4587	545	22-047649	VNE-4764	377	22-049384	VNE-4938	695	22-053077	VNE-5307	502
22-045027	VNE-4502	789	22-045874	VNE-4587	546	22-047656	VNE-4765	371	22-049384	VNE-4938	696	22-053077	VNE-5307	718
22-045027	VNE-4502	844	22-045874	VNE-4587	746	22-047663	VNE-4766	371	22-049391	VNE-4939	695	22-053077	VNE-5307	719
22-045027	VNE-4502	858	22-045874	VNE-4587	747	22-047670	VNE-4767	371	22-049391	VNE-4939	696	22-053077	VNE-5307	721
22-045034	VNE-4503	151	22-045874	VNE-4587	748	22-047687	VNE-4768	371	22-049445	VNE-4944	691	22-053077	VNE-5307	722
22-045041	VNE-4504	151	22-045881	VNE-4588	544	22-047724	VNE-4772	377	22-049445	VNE-4944	692	22-053541	VNE-5354	387
22-045072	VNE-4507	460	22-045881	VNE-4588	545	22-047755	VNE-4775	460	22-049452	VNE-4945	691	22-053596	VNE-5359	346
22-045089	VNE-4508	460	22-045881	VNE-4588	546	22-047762	VNE-4776	460	22-049452	VNE-4945	692	22-053602	VNE-5360	346
22-045089	VNE-4508	463	22-045881	VNE-4588	746	22-047786	VNE-4784	465	22-049469	VNE-4946	696	22-053619	VNE-5361	346
22-045089	VNE-4508	464	22-045881	VNE-4588	747	22-047816	VNE-4781	464	22-049469	VNE-4946	697	22-053626	VNE-5362	346
22-045119	VNE-4511	375	22-045881	VNE-4588	748	22-047823	VNE-4782	340	22-049476	VNE-4947	696	22-059543	VNE-5954	691
22-045126	VNE-4512	375	22-045942	VNE-4594	358	22-047823	VNE-4782	352	22-049476	VNE-4947	697	22-059543	VNE-5954	692
22-045133	VNE-4513	375	22-045959	VNE-4595	197	22-047823	VNE-4782	468	22-049483	VNE-4948	690	22-059550	VNE-5955	691
22-045461	VNE-4546	2	22-045959	VNE-4595	565	22-047823	VNE-4782	469	22-049483	VNE-4948	691	22-059550	VNE-5955	692
22-045461	VNE-4546	3	22-045959	VNE-4595	566	22-047847	VNE-4784	461	22-049490	VNE-4949	690	22-100030	VNE-A003	196
22-045461	VNE-4546	4	22-045959	VNE-4595	567	22-047847	VNE-4784	600	22-049490	VNE-4949	691	22-100030	VNE-A003	211
22-045478	VNE-4547	360	22-045959	VNE-4595	580	22-047854	VNE-4785	461	22-049506	VNE-4950	693	22-100047	VNE-A004	196
22-045485	VNE-4548	237	22-045966	VNE-4596	197	22-047854	VNE-4785	600	22-049513	VNE-4951	693	22-100047	VNE-A004	211
22-045485	VNE-4548	238	22-045966	VNE-4596	565	22-047922	VNE-4792	481	22-049582	VNE-4958	689	22-100177	VNE-A017	141
22-045492	VNE-4549	237	22-045966	VNE-4596	566	22-047939	VNE-4793	481	22-049582	VNE-4958	690	22-100177	VNE-A017	143
22-045508	VNE-4550	228	22-045966	VNE-4596	567	22-047946	VNE-4794	471	22-049599	VNE-4959	689	22-100412	VNE-A041	387
22-045508	VNE-4550	229	22-045966	VNE-4596	580	22-047946	VNE-4794	486	22-049599	VNE-4959	690	22-100436	VNE-A043	408
22-045515	VNE-4551	278	22-046123	VNE-4612	590	22-047946	VNE-4794	487	22-049605	VNE-4960	697	22-100436	VNE-A043	409
22-045515	VNE-4551	279	22-046123	VNE-4612	591	22-047953	VNE-4795	471	22-049605	VNE-4960	698	22-100436	VNE-A043	412
22-045522	VNE-4552	266	22-046130	VNE-4613	590	22-047953	VNE-4795	486	22-049612	VNE-4961	697	22-100436	VNE-A043	413
22-045522	VNE-4552	268	22-046130	VNE-4613	591	22-047953	VNE-4795	487	22-049612	VNE-4961	698	22-100436	VNE-A043	414
22-045522	VNE-4552	269	22-046130	VNE-4613	592	22-047960	VNE-4796	473	22-049636	VNE-4963	688	22-102348	VNE-A234	675
22-045546	VNE-4554	267	22-046215	VNE-4621	598	22-047960	VNE-4796	474	22-049698	VNE-4969	383	22-102621	VNE-A262	612
22-045546	VNE-4554	269	22-046222	VNE-4622	598	22-047977	VNE-4797	473	22-050106	VNE-5010	221	22-102621	VNE-A262	613
22-045546	VNE-4554	367	22-046239	VNE-4623	598	22-047977	VNE-4797	474	22-050113	VNE-5011	221	22-102645	VNE-A264	612
22-045553	VNE-4555	267	22-046246	VNE-4624	598	22-048028	VNE-4802	681	22-050120	VNE-5012	187	22-102645	VNE-A264	613
22-045553	VNE-4555	269	22-046390	VNE-4639	360	22-048035	VNE-4803	681	22-050120	VNE-5012	220	22-103093	VNE-A309	115
22-045553	VNE-4555	368	22-046734	VNE-4673	206	22-048066	VNE-4806	681	22-050137	VNE-5013	187	22-103093	VNE-A309	118
22-045560	VNE-4556	263	22-046734	VNE-4673	207	22-048073	VNE-4807	681	22-050137	VNE-5013	220	22-103093	VNE-A309	119
22-045560	VNE-4556	264	22-046734	VNE-4673	243	22-048103	VNE-4810	685	22-051189	VNE-5118	615	22-103093	VNE-A309	121
22-045560	VNE-4556	265	22-046734	VNE-4673	248	22-048110	VNE-4811	685	22-051196	VNE-5119	615	22-103093	VNE-A309	160
22-045560	VNE-4556	266	22-046734	VNE-4673	360	22-048117	VNE-4817	705	22-051202	VNE-5120	615	22-103109	VNE-A310	115
22-045584	VNE-4558	280	22-046734	VNE-4673	577	22-048172	VNE-4817	706	22-051219	VNE-5121	270	22-103109	VNE-A310	118
22-045584	VNE-4558	303	22-046734	VNE-4673	578	22-048202	VNE-4820	691	22-051219	VNE-5121	271	22-103109	VNE-A310	119
22-045607	VNE-4560	280	22-046734	VNE-4673	579	22-048202	VNE-4820	692	22-051226	VNE-5122	270	22-103109	VNE-A310	121
22-045607	VNE-4560	281	22-046741	VNE-4674	232	22-048219	VNE-4821	691	22-051226	VNE-5122	271	22-103109	VNE-A310	160
22-045607	VNE-4560	303	22-046758	VNE-4675	234	22-048219	VNE-4821	692	22-051707	VNE-5170	117	22-103130	VNE-A313	115
22-045614	VNE-4561	281	22-046765	VNE-4676	234	22-048226	VNE-4822	706	22-051714	VNE-5171	117	22-103130	VNE-A313	118
22-045614	VNE-4561	303	22-046772	VNE-4677	231	22-048264	VNE-4826	704	22-051813	VNE-5181	227	22-103130	VNE-A313	119
22-045621	VNE-4562	280	22-046772	VNE-4677	359	22-048271	VNE-4827	704	22-051813	VNE-5181	229	22-103130	VNE-A313	121
22-045621	VNE-4562	281	22-046789	VNE-4678	231	22-048325	VNE-4832	689	22-051813	VNE-5181	247	22-103147	VNE-A314	115
22-045621	VNE-4562	303	22-046789	VNE-4678	359	22-048325	VNE-4832	690	22-052261	VNE-5226	676	22-103147	VNE-A314	118
22-045638	VNE-4563	462	22-046796	VNE-4679	277	22-048332	VNE-4833	689	22-052261	VNE-5226	676	22-103147	VNE-A314	119
22-045669	VNE-4566	196	22-046796	VNE-4679	632	22-048332	VNE-4833	690	22-052544	VNE-5254	5	22-103147	VNE-A314	121
22-045669	VNE-4566	197	22-046796	VNE-4679	853	22-048349	VNE-4834	697	22-052544	VNE-5254	7	22-104885	VNE-A488	156
22-045669	VNE-4566	209	22-046802	VNE-4680	460	22-048349	VNE-4834	698	22-052544	VNE-5254	11	22-104892	VNE-A489	156
22-045669	VNE-4566	210	22-046802	VNE-4680	757	22-048356	VNE-4835	697	22-052568	VNE-5256	590	22-105349	VNE-A534	239
22-045669	VNE-4566	565	22-046819	VNE-4681	460	22-048356	VNE-4835	698	22-052568	VNE-5256	591	22-105349	VNE-A534	877
22-045669	VNE-4566	579	22-046819	VNE-4681	757	22-048820	VNE-4882	337	22-052704	VNE-5270	707	22-105356	VNE-A535	239
22-045669	VNE-4566	580	22-046826	VNE-4682	573	22-048837	VNE-4883	337	22-052728	VNE-5272	590	22-105356	VNE-A535	240
22-045676	VNE-4567	196	22-046826	VNE-4682	574	22-048844	VNE-4884	337	22-052728	VNE-5272	591	22-105813	VNE-A581	16
22-045676	VNE-4567	197	22-046833	VNE-4683	573	22-048851	VNE-4885	337	22-052810	VNE-5281	115	22-105813	VNE-A581	639
22-045676	VNE-4567	209	22-046833	VNE-4683	574	22-048912	VNE-4891	369	22-052810	VNE-5281	118	22-105813	VNE-A581	643
22-045676	VNE-4567	210	22-046840	VNE-4684	609	22-048912	VNE-4891	370	22-052810	VNE-5281	121	22-105813	VNE-A581	656
22-045676	VNE-4567	565	22-046840	VNE-4684	610	22-048936	VNE-4893	369	22-052827	VNE-5282	115	22-105813	VNE-A581	657
22-045676	VNE-4567	579	22-046840	VNE-4684	611	22-048936	VNE-4893	370	22-052827	VNE-5282	118	22-105813	VNE-A581	658
22-045676	VNE-4567	580	22-046857	VNE-4685	611	22-048974	VNE-4897	370	22-052827	VNE-5282	121	22-105813	VNE-A581	659
22-045683	VNE-4568	572	22-046864	VNE-4686	607	22-048974	VNE-4897	371	22-052834	VNE-5283	13	22-105813	VNE-A581	670
22-045706	VNE-4570	631	22-046871	VNE-4687	607	22-048974	VNE-4897	372	22-052834	VNE-5283	116	22-105813	VNE-A581	671
22-045720	VNE-4572	659	22-046888	VNE-4688	607	22-049001	VNE-4900	375	22-052834	VNE-5283	118	22-105813	VNE-A581	783
22-045737	VNE-4573	659	22-047281	VNE-4728	327	22-049018	VNE-4901	375	22-052834	VNE-5283	121	22-105813	VNE-A581	846
22-045737	VNE-4573	660	22-047281	VNE-4728	334	2								



# New order number – Old order number

New	Old	Page	New	Old	Page	New	Old	Page	New	Old	Page	New	Old	Page
22-110442	VNE-B044	739	22-118738	VNE-B873	749	22-135032	VNE-D503	123	22-141590	VNE-E159	503	22-147523	VN7-E752	594
22-110459	VNE-B045	183	22-118738	VNE-B873	751	22-135032	VNE-D503	126	22-141590	VNE-E159	504	22-147530	VA7-E753	592
22-110459	VNE-B045	320	22-118738	VNE-B873	753	22-135032	VNE-D503	161	22-141590	VNE-E159	505	22-147530	VA7-E753	593
22-110459	VNE-B045	512	22-118745	VNE-B874	231	22-135049	VNE-D504	14	22-141590	VNE-E159	507	22-147554	VA7-E755	592
22-110459	VNE-B045	517	22-118745	VNE-B874	539	22-135049	VNE-D504	15	22-141590	VNE-E159	508	22-147554	VA7-E755	593
22-110459	VNE-B045	518	22-118745	VNE-B874	547	22-135049	VNE-D504	123	22-141590	VNE-E159	553	22-147554	VA7-E755	594
22-110459	VNE-B045	531	22-118745	VNE-B874	549	22-135049	VNE-D504	126	22-141590	VNE-E159	554	22-147561	VA7-E756	592
22-110459	VNE-B045	732	22-118745	VNE-B874	551	22-135049	VNE-D504	161	22-141590	VNE-E159	723	22-147561	VA7-E756	593
22-110459	VNE-B045	734	22-118745	VNE-B874	744	22-135971	VNE-D597	293	22-141590	VNE-E159	724	22-147561	VA7-E756	594
22-110459	VNE-B045	735	22-118745	VNE-B874	749	22-135971	VNE-D597	294	22-141590	VNE-E159	725	22-147578	VN7-E757	598
22-110459	VNE-B045	739	22-118745	VNE-B874	751	22-135971	VNE-D597	295	22-141590	VNE-E159	726	22-147578	VN7-E757	599
22-110893	VNE-B089	576	22-118745	VNE-B874	753	22-136572	VNE-D657	128	22-141590	VNE-E159	755	22-147585	VN7-E758	598
22-110909	VNE-B090	576	22-119186	VNE-B918	453	22-136589	VNE-D658	128	22-141606	VNE-E160	191	22-147585	VN7-E758	599
22-111074	VNE-B107	141	22-119186	VNE-B918	454	22-136602	VNE-D660	128	22-141606	VNE-E160	317	22-147592	VA7-E759	598
22-111074	VNE-B107	143	22-119193	VNE-B919	453	22-136619	VNE-D661	128	22-141606	VNE-E160	318	22-147592	VA7-E759	599
22-111081	VNE-B108	141	22-119193	VNE-B919	454	22-137197	VNE-D719	560	22-141606	VNE-E160	319	22-147608	VA7-E760	598
22-111081	VNE-B108	143	22-119261	VNE-B926	154	22-137203	VNE-D720	560	22-141606	VNE-E160	503	22-147608	VA7-E760	599
22-111111	VNE-B111	699	22-119278	VNE-B927	154	22-138361	VNE-D836	144	22-141606	VNE-E160	504	22-151032	VNE-F103	398
22-111111	VNE-B111	700	22-119315	VNE-B931	235	22-138361	VNE-D836	145	22-141606	VNE-E160	505	22-151032	VNE-F103	400
22-111128	VNE-B112	699	22-119315	VNE-B931	244	22-138361	VNE-D836	162	22-141606	VNE-E160	507	22-151032	VNE-F103	401
22-111128	VNE-B112	700	22-119315	VNE-B931	257	22-138392	VNE-D839	282	22-141606	VNE-E160	508	22-151032	VNE-F103	450
22-111715	VNE-B171	606	22-120199	VNE-C019	757	22-138392	VNE-D839	283	22-141606	VNE-E160	553	22-151049	VNE-F104	399
22-111760	VNE-B176	268	22-120205	VNE-C020	757	22-138392	VNE-D839	302	22-141606	VNE-E160	554	22-151049	VNE-F104	400
22-111760	VNE-B176	368	22-122469	VNE-C246	216	22-138712	VNE-D871	696	22-141606	VNE-E160	723	22-151056	VNE-F105	672
22-111777	VNE-B177	268	22-122469	VNE-C246	217	22-138712	VNE-D871	697	22-141606	VNE-E160	724	22-151056	VNE-F105	673
22-111777	VNE-B177	368	22-122469	VNE-C246	356	22-138729	VNE-D872	696	22-141606	VNE-E160	725	22-151056	VNE-F105	835
22-112743	VNE-B274	277	22-122469	VNE-C246	366	22-138729	VNE-D872	697	22-141606	VNE-E160	726	22-151056	VNE-F105	836
22-112750	VNE-B275	277	22-122469	VNE-C246	609	22-139122	VNE-D912	205	22-141606	VNE-E160	755	22-151056	VNE-F105	837
22-112774	VNE-B277	338	22-123602	VNE-C360	153	22-139122	VNE-D912	248	22-141705	VNE-E170	392	22-151056	VNE-F105	838
22-112774	VNE-B277	341	22-123619	VNE-C361	153	22-139122	VNE-D912	359	22-141705	VNE-E170	393	22-151056	VNE-F105	839
22-112781	VNE-B278	338	22-127426	VNE-C742	602	22-139122	VNE-D912	577	22-141705	VNE-E170	395	22-151056	VNE-F105	840
22-112781	VNE-B278	341	22-127426	VNE-C742	603	22-139184	VNE-D918	19	22-141705	VNE-E170	396	22-151056	VNE-F105	875
22-112798	VNE-B279	338	22-128188	VNE-C818	605	22-139184	VNE-D918	23	22-141705	VNE-E170	404	22-151070	VNE-F107	672
22-112798	VNE-B279	341	22-128188	VNE-C818	618	22-139184	VNE-D918	632	22-141705	VNE-E170	405	22-151070	VNE-F107	673
22-112804	VNE-B280	338	22-128201	VNE-C820	337	22-139184	VNE-D918	634	22-142429	VN3-E242	866	22-151070	VNE-F107	835
22-112804	VNE-B280	341	22-128218	VNE-C821	337	22-139184	VNE-D918	647	22-142429	VN3-E242	867	22-151070	VNE-F107	836
22-112811	VNE-B281	272	22-128225	VNE-C822	205	22-139184	VNE-D918	654	22-142429	VN3-E242	868	22-151070	VNE-F107	837
22-112811	VNE-B281	273	22-128225	VNE-C822	248	22-139184	VNE-D918	663	22-142429	VN3-E242	869	22-151070	VNE-F107	838
22-112811	VNE-B281	274	22-128225	VNE-C822	359	22-139184	VNE-D918	665	22-142436	VN3-E243	866	22-151070	VNE-F107	839
22-112811	VNE-B281	275	22-128225	VNE-C822	577	22-139184	VNE-D918	674	22-142436	VN3-E243	867	22-151070	VNE-F107	840
22-112811	VNE-B281	302	22-128249	VNE-C824	576	22-139184	VNE-D918	779	22-142436	VN3-E243	868	22-151070	VNE-F107	875
22-112811	VNE-B281	372	22-128256	VNE-C825	576	22-139184	VNE-D918	780	22-142436	VN3-E243	869	22-151094	VNE-F109	705
22-112811	VNE-B281	373	22-128287	VNE-C828	235	22-139184	VNE-D918	796	22-143358	VNE-E335	291	22-151100	VNE-F110	705
22-112811	VNE-B281	374	22-128300	VNE-C830	436	22-139184	VNE-D918	814	22-143358	VNE-E335	292	22-151223	VNE-F122	331
22-112811	VNE-B281	382	22-128300	VNE-C830	437	22-139184	VNE-D918	816	22-143365	VNE-E336	291	22-151230	VNE-F123	331
22-112811	VNE-B281	756	22-131492	VNE-D149	607	22-139184	VNE-D918	870	22-143365	VNE-E336	292	22-151773	VNE-F177	339
22-112811	VNE-B281	758	22-131492	VNE-D149	608	22-139184	VNE-D918	872	22-143372	VNE-E337	291	22-151780	VNE-F178	339
22-112811	VNE-B281	761	22-131607	VNE-D160	19	22-139191	VNE-D919	19	22-143372	VNE-E337	292	22-152749	VNE-F274	99
22-112811	VNE-B281	772	22-131607	VNE-D160	23	22-139191	VNE-D919	23	22-143389	VNE-E338	291	22-152749	VNE-F274	100
22-112880	VNE-B288	272	22-131607	VNE-D160	26	22-139191	VNE-D919	632	22-143389	VNE-E338	292	22-152756	VNE-F275	99
22-112880	VNE-B288	273	22-131607	VNE-D160	632	22-139191	VNE-D919	634	22-144249	VNE-E424	96	22-152756	VNE-F275	100
22-112880	VNE-B288	274	22-131607	VNE-D160	634	22-139191	VNE-D919	647	22-144249	VNE-E424	98	22-152770	VNE-F277	99
22-112880	VNE-B288	275	22-131607	VNE-D160	647	22-139191	VNE-D919	654	22-144256	VNE-E425	96	22-152770	VNE-F277	100
22-112880	VNE-B288	302	22-131607	VNE-D160	654	22-139191	VNE-D919	663	22-144256	VNE-E425	98	22-152787	VNE-F278	99
22-112880	VNE-B288	372	22-131607	VNE-D160	663	22-139191	VNE-D919	665	22-144263	VNE-E426	96	22-152787	VNE-F278	100
22-112880	VNE-B288	373	22-131607	VNE-D160	665	22-139191	VNE-D919	674	22-144263	VNE-E426	98	22-155344	VNE-F534	759
22-112880	VNE-B288	374	22-131607	VNE-D160	674	22-139191	VNE-D919	779	22-144270	VNE-E427	96	22-155344	VNE-F534	763
22-112880	VNE-B288	382	22-131607	VNE-D160	779	22-139191	VNE-D919	780	22-144270	VNE-E427	98	22-155344	VNE-F534	764
22-112880	VNE-B288	756	22-131607	VNE-D160	780	22-139191	VNE-D919	796	22-144928	VNE-E492	331	22-156358	VNE-F635	689
22-112880	VNE-B288	758	22-131607	VNE-D160	795	22-139191	VNE-D919	815	22-144928	VNE-E492	332	22-156358	VNE-F636	689
22-112880	VNE-B288	761	22-131607	VNE-D160	799	22-139191	VNE-D919	816	22-144935	VNE-E493	331	22-156655	VNE-F665	617
22-112880	VNE-B288	772	22-131607	VNE-D160	806	22-139191	VNE-D919	852	22-144935	VNE-E493	332	22-156662	VNE-F666	617
22-113115	VNE-B311	201	22-131607	VNE-D160	810	22-139191	VNE-D919	870	22-145246	VNE-E524	130	22-156679	VNE-F667	465
22-113115	VNE-B311	202	22-131607	VNE-D160	814	22-139191	VNE-D919	872	22-145253	VNE-E525	130	22-156830	VNE-F839	615
22-113115	VNE-B311	203	22-131607	VNE-D160	816	22-139320	VNE-D932	810	22-145277	VNE-E527	130	22-156830	VNE-F839	616
22-113115	VNE-B311	568	22-131607	VNE-D160	870	22-139320	VNE-D932	856	22-145284	VNE-E528	130	22-158475	VNE-F847	233
22-113115	VNE-B311	569	22-131607	VNE-D160	872	22-139320	VNE-D932	877	22-145550	VNE-E555	17	22-158475	VNE-F847	240
22-113115	VNE-B311	570	22-131614	VNE-D161	19	22-139924	VNE-D992	282	22-145550	VNE-E555	75	22-158475	VNE-F847	241
22-113313	VNE-B331	598	22-131614	VNE-D161	23	22-139924	VNE-D992	302	22-145550	VNE-E555	73	22-158475	VNE-F847	242
22-113320	VNE-B332	598	22-131614	VNE-D161	26	22-139931	VNE-D993	115	22-145550	VNE-E555	646	22-158475	VNE-F847	519
22-113337	VNE-B333	590	22-131614	VNE-D161	632	22-139931	VNE-D993	116	22-145550	VNE-E555	653	22-158475	VNE-F847	520
22-113337	VNE-B333	591	22-131614	VNE-D161	634	22-139931	VNE-D993	118	22-145550	VNE-E555	775	22-158475	VNE-F847	736
22-113344	VNE-B334	590	22-131614	VNE-D161	647	22-139931	VNE-D993	119	22-145550	VNE-E555	777	22-158482	VNE-F848	233
22-113344	VNE-B334	591	22-131614	VNE-D161	654	22-139931	VNE-D993	121	22-145550	VNE-E555	79			



# New order number – Old order number

New	Old	Page	New	Old	Page	New	Old	Page	New	Old	Page	New	Old	Page
22-165787	VNE-G578	479	22-171009	VNE-H100	457	22-183682		522	22-194091		451	22-213785		532
22-165794	VNE-G579	335	22-171009	VNE-H100	458	22-183682		737	22-194107		423	22-213785		739
22-165800	VNE-G580	335	22-171009	VNE-H100	459	22-183682		738	22-194107		451	22-213808		335
22-165954	VNE-G595	226	22-171443	VNE-H144	617	22-183699		570	22-195241		200	22-213815		335
22-165978	VNE-G597	690	22-172433	VNE-H243	231	22-183699		571	22-195241		205	22-213839		466
22-165985	VNE-G598	690	22-172433	VNE-H243	232	22-183705		15	22-195258		200	22-213846		466
22-166029	VNE-G602	678	22-172518	VNE-H251	108	22-183705		16	22-195258		205	22-213860		466
22-166036	VNE-G603	678	22-172518	VNE-H251	110	22-183705		643	22-195302		10	22-213877		466
22-166371	VNE-G637	217	22-172518	VNE-H251	111	22-183705		644	22-195302		224	22-213983		332
22-166371	VNE-G637	615	22-172518	VNE-H251	113	22-183705		645	22-195302		257	22-213990		332
22-166494	VNE-G649	340	22-172518	VNE-H251	114	22-183705		655	22-195319		10	22-214065		406
22-166500	VNE-G650	340	22-172525	VNE-H252	108	22-183705		669	22-195319		224	22-214065		407
22-166661	VNE-G666	398	22-172525	VNE-H252	110	22-183705		848	22-195319		257	22-214089		334
22-166661	VNE-G666	400	22-172525	VNE-H252	111	22-183705		876	22-196019		398	22-214096		334
22-166661	VNE-G666	450	22-172525	VNE-H252	113	22-183712		674	22-196019		400	22-214287		123
22-166722	VNE-G672	367	22-172525	VNE-H252	114	22-183712		773	22-196019		401	22-214287		126
22-166722	VNE-G672	490	22-172662	VNE-H266	198	22-183712		774	22-196019		450	22-214287		128
22-166722	VNE-G672	684	22-172662	VNE-H266	466	22-183712		802	22-196309		656	22-214294		123
22-166722	VNE-G672	686	22-172662	VNE-H266	577	22-183712		805	22-196309		657	22-214294		126
22-166722	VNE-G672	687	22-172679	VNE-H267	198	22-183712		875	22-196330		339	22-214294		128
22-166722	VNE-G672	710	22-172679	VNE-H267	466	22-183712		876	22-196347		339	22-214300		123
22-166739	VNE-G673	367	22-172679	VNE-H267	577	22-183729		674	22-196408		351	22-214300		128
22-166739	VNE-G673	490	22-172839	VNE-H283	11	22-183729		802	22-196408		352	22-214300		130
22-166739	VNE-G673	684	22-172846	VNE-H284	11	22-183729		805	22-196408		354	22-214317		123
22-166739	VNE-G673	686	22-173560	VNE-H356	333	22-183750		72	22-196415		351	22-214317		128
22-166739	VNE-G673	687	22-173577	VNE-H357	333	22-183750		854	22-196606		352	22-214317		130
22-166739	VNE-G673	710	22-181459	VNE-4457	690	22-183750		876	22-196606		5	22-214751		438
22-166746	VNE-G674	478	22-181602	V36-0156	588	22-183828	VNE-H775	200	22-196606		11	22-214751		439
22-166753	VNE-G675	478	22-181619	V36-0367	108	22-183828	VNE-H775	562	22-196651		704	22-214751		440
22-167002	VNE-G700	707	22-181619	V36-0367	111	22-183828	VNE-H775	563	22-196682		704	22-214751		441
22-167019	VNE-G701	707	22-181626	V36-0368	108	22-183828	VNE-H775	564	22-196682		215	22-214751		862
22-167071	VNE-G707	603	22-181626	V36-0368	111	22-183835	VNE-H776	200	22-196682		255	22-214768		442
22-167071	VNE-G707	604	22-181633	V36-0369	108	22-183835	VNE-H776	562	22-196682		256	22-214768		443
22-167071	VNE-G707	614	22-181633	V36-0369	111	22-183835	VNE-H776	563	22-196682		583	22-214768		862
22-167293	VNE-G729	340	22-181640	V36-0370	108	22-183835	VNE-H776	564	22-196682		584	22-215482		236
22-167309	VNE-G730	340	22-181640	V36-0370	111	22-183842		153	22-196859		632	22-215505		236
22-168061	VNE-G806	392	22-182821		279	22-183842		163	22-196859		854	22-215734		384
22-168061	VNE-G806	393	22-182838		279	22-183859		153	22-196873		704	22-215796		384
22-168061	VNE-G806	396	22-182869		278	22-183859		163	22-196880		704	22-215802		384
22-168085	VNE-G808	392	22-182869		283	22-183873		152	22-196934		236	22-215819		384
22-168085	VNE-G808	394	22-182869		284	22-183873		163	22-196941		236	22-215819		386
22-168085	VNE-G808	395	22-182869		291	22-183880		152	22-196958		236	22-215826		384
22-168085	VNE-G808	396	22-182869		302	22-183880		163	22-196965		236	22-215826		386
22-168085	VNE-G808	404	22-182869		303	22-183897		157	22-197313		436	22-215833		386
22-168085	VNE-G808	405	22-182869		760	22-183903		157	22-197313		451	22-215840		386
22-168337	VNE-G833	688	22-182869		763	22-184160	VNE-H888	562	22-197320		866	22-215895		453
22-168337	VNE-G833	700	22-182869		764	22-184160	VNE-H888	563	22-197320		867	22-215895		455
22-168344	VNE-G834	688	22-182869		773	22-184160	VNE-H888	564	22-197320		868	22-215895		456
22-168344	VNE-G834	700	22-182876		278	22-184177	VNE-H889	562	22-197320		869	22-215895		457
22-168597	VNE-G859	164	22-182876		283	22-184177	VNE-H889	563	22-197337		866	22-215895		458
22-168597	VNE-G859	166	22-182876		284	22-184177	VNE-H889	564	22-197337		867	22-215895		459
22-168597	VNE-G859	167	22-182876		291	22-184207		701	22-197337		868	22-215949		453
22-168597	VNE-G859	539	22-182876		302	22-184221		701	22-197337		869	22-215949		455
22-168597	VNE-G859	547	22-182876		303	22-184238		444	22-197351		250	22-215949		456
22-168597	VNE-G859	549	22-182876		760	22-184238		445	22-197351		251	22-215949		457
22-168597	VNE-G859	552	22-182876		763	22-184238		446	22-197351		279	22-215949		458
22-168597	VNE-G859	744	22-182876		764	22-184238		447	22-197368		250	22-215949		459
22-168597	VNE-G859	750	22-182876		773	22-184238		859	22-197368		251	22-216540		354
22-168597	VNE-G859	751	22-183415		214	22-184238		860	22-197368		279	22-216557		354
22-168597	VNE-G859	753	22-183415		215	22-184245		444	22-197665		423	22-217134		273
22-168603	VNE-G860	164	22-183415		255	22-184245		445	22-197665		424	22-217134		276
22-168603	VNE-G860	166	22-183415		256	22-184245		446	22-197672		153	22-217134		277
22-168603	VNE-G860	167	22-183415		583	22-184245		447	22-197689		153	22-217141		273
22-168603	VNE-G860	539	22-183644		165	22-184245		448	22-197849		424	22-217141		276
22-168603	VNE-G860	547	22-183644		166	22-184245		859	22-197849		425	22-217141		277
22-168603	VNE-G860	549	22-183644		180	22-184245		860	22-197931		244	22-217271		235
22-168603	VNE-G860	552	22-183644		191	22-184245		861	22-199492		118	22-217653		250
22-168603	VNE-G860	744	22-183644		321	22-184283	VNE-H783	151	22-199492		119	22-217653		251
22-168603	VNE-G860	750	22-183644		322	22-184283	VNE-H783	152	22-199508		118	22-217653		279
22-168603	VNE-G860	751	22-183644		509	22-184306	VNE-H784	151	22-199508		119	22-217660		250
22-168603	VNE-G860	753	22-183644		510	22-184306	VNE-H784	152	22-205414		631	22-217660		251
22-168665	VNE-G866	209	22-183644		554	22-188632		268	22-205438		631	22-217660		279
22-168665	VNE-G866	210	22-183644		726	22-188649		268	22-210692		484	22-217684		250
22-168672	VNE-G867	209	22-183644		727	22-188663		368	22-210692		489	22-217684		251
22-168672	VNE-G867	210	22-183644		755	22-189271		207	22-210739		484	22-217684		279
22-168771	VNE-G877	436	22-183651		165	22-189271		233	22-210739		489	22-217691		250
22-168771	VNE-G877	437	22-183651		166	22-189271		242	22-212696		144	22-217691		251
22-169976	VNE-G997	704	22-183651		180	22-189271		578	22-212696		146	22-217691		279
22-169983	VNE-G998	704	22-183651		191	22-189288		207	22-212986		683	22-217721		193
22-170071	VNE-H007	75	22-183651		321	22-189288		233	22-212986		687	22-217721		360
22-170071	VNE-H007	76	22-183651		322	22-189288		242	22-212986		683	22-217981		100
22-170217	VNE-H021	398	22-183651		509	22-189288		578	22-212993		687	22-217981		102
22-170217	VNE-H021	400	22-183651		510	22-193032		866	22-213136		154	22-218001		100
22-170217	VNE-H021	450	22-183651		554	22-193032		867	22-213143		154	22-218001		



## New order number – Old order number

New	Old	Page	New	Old	Page	New	Old	Page	New	Old	Page	New	Old	Page
22-218865		354	22-225252		564	22-229373		739	22-232908		578	22-238269		131
22-218919		151	22-225269		616	22-229380		165	22-232915		578	22-238276		131
22-218926		151	22-225290		207	22-229380		190	22-233677	VN3-4277	781	22-238818		509
22-219589		785	22-225290		243	22-229380		532	22-233707		165	22-238818		727
22-219947		595	22-225290		579	22-229380		739	22-233707		190	22-239075		509
22-219947		596	22-225306		207	22-229397		165	22-233707		532	22-239075		727
22-220066		131	22-225306		243	22-229397		190	22-233707		739	22-239099		490
22-220066		133	22-225306		579	22-229397		532	22-233721		165	22-239105		490
22-220066		134	22-226372		484	22-229397		739	22-233721		190	22-239129		490
22-220066		161	22-226372		489	22-229427		707	22-233721		532	22-239143		490
22-220080		131	22-226389		484	22-229434		707	22-233721		739	22-239594		778
22-220080		134	22-226389		489	22-229458		707	22-233745		165	22-239594		784
22-220080		161	22-226464		475	22-229465		707	22-233745		191	22-239594		851
22-220103		385	22-226464		476	22-229502		682	22-233745		532	22-240125		617
22-220103		386	22-226471		475	22-229519		682	22-233745		740	22-240583		100
22-220103		402	22-226471		476	22-229564		682	22-233752		165	22-240583		102
22-220127		385	22-226556		192	22-229571		682	22-233752		191	22-240590		100
22-220127		386	22-226556		230	22-229656		351	22-233752		532	22-240590		102
22-220127		402	22-226556		245	22-229663		351	22-233752		740	22-243034		379
22-220530		276	22-226556		246	22-229670		203	22-234636		153	22-243041		379
22-220547		276	22-226556		359	22-229687		203	22-234643		153	22-243058		379
22-220554		773	22-226563		192	22-230522		667	22-235039		216	22-243065		379
22-220578		115	22-226563		230	22-230522		668	22-235039		604	22-243201		686
22-220578		118	22-226563		245	22-230522		807	22-235053		216	22-243218		686
22-220578		121	22-226563		246	22-230522		808	22-235536		762	23-218482		595
22-220585		115	22-226563		359	22-230522		809	22-235536		770	23-218482		596
22-220585		118	22-226570		192	22-230539		667	22-235367		217	23-218482		598
22-220585		121	22-226570		230	22-230539		668	22-235367		615	23-218482		600
22-221407		327	22-226570		245	22-230539		807	22-235428		198	23-219960		595
22-221414		327	22-226570		246	22-230539		808	22-235428		557	23-219960		596
22-221490		147	22-226570		359	22-230539		809	22-235428		689	23-219984		595
22-221490		148	22-226631		438	22-230652		598	22-235435		198	23-219984		596
22-222046		651	22-226631		439	22-230652		600	22-235435		557	23-230668		598
22-222046		655	22-226631		440	22-230676		708	22-235435		689	23-230668		600
22-222046		856	22-226631		441	22-230676		709	22-235459		198	23-231153		598
22-222084		651	22-226648		442	22-230683		708	22-235459		557	23-231160		598
22-222084		655	22-226648		443	22-230683		709	22-235459		689	23-233324		152
22-222084		856	22-226716		197	22-230867		144	22-235466		198	23-233331		152
22-222107		651	22-226716		198	22-230867		146	22-235466		557	24-000024	B46-0002	409
22-222107		655	22-226716		203	22-230874		144	22-235466		689	24-000024	B46-0002	425
22-222107		856	22-226716		580	22-230874		146	22-235527		236	24-000024	B46-0002	429
22-222121		367	22-226723		197	22-230935		385	22-235534		236	24-000123	B46-0012	409
22-222121		490	22-226723		198	22-230935		402	22-235565		236	24-000123	B46-0012	425
22-222121		685	22-226723		203	22-230942		385	22-235572		236	24-000123	B46-0012	429
22-222121		686	22-226723		580	22-230942		402	22-235626		236	24-000321	B46-0032	95
22-222121		687	22-226969		192	22-230959		760	22-235633		236	24-000321	B46-0032	817
22-222121		710	22-226976		192	22-230959		761	22-235657		236	24-000321	B46-0032	859
22-222138		367	22-226983		192	22-230959		762	22-235664		236	24-000321	B46-0032	863
22-222138		490	22-227065		232	22-230959		769	22-235688		236	24-000338	B46-0033	817
22-222138		685	22-227065		512	22-230959		770	22-235695		236	24-000345	B46-0034	817
22-222138		686	22-227072		232	22-231116		598	22-235718		236	24-000574	B46-0057	471
22-222138		687	22-227072		512	22-231123		598	22-235725		236	24-000574	B46-0057	475
22-222138		710	22-227553		286	22-231130		598	22-235749		291	24-000574	B46-0057	476
22-222152		367	22-227706		278	22-231147		598	22-235756		291	24-000642	BE3-H821	105
22-222152		491	22-227706		291	22-231369		490	22-235770		291	24-000642	BE3-H821	107
22-222152		685	22-227713		278	22-231369		710	22-235787		291	24-000819	B46-0081	491
22-222152		686	22-227713		291	22-231376		490	22-235817		334	24-000857	B36-0085	165
22-222152		687	22-227720		379	22-231376		710	22-235824		334	24-000857	B36-0085	167
22-222152		710	22-227737		379	22-231444		215	22-235848		334	24-000857	B36-0085	178
22-222169		367	22-227782		463	22-231925		332	22-235855		334	24-000857	B36-0085	320
22-222169		491	22-227799		463	22-231925		333	22-235886		339	24-000857	B36-0085	513
22-222169		685	22-227812		463	22-231932		332	22-235893		339	24-000857	B36-0085	514
22-222169		686	22-227829		463	22-231932		333	22-235916		339	24-000857	B36-0085	515
22-222169		687	22-227966		231	22-232045		183	22-235923		339	24-000857	B36-0085	516
22-222169		710	22-227973		291	22-232045		518	22-235954		351	24-000857	B36-0085	540
22-223395		385	22-227973		292	22-232052		183	22-235954		352	24-000857	B36-0085	733
22-223395		386	22-227980		291	22-232052		518	22-235961		351	24-000857	B36-0085	734
22-223395		402	22-227980		292	22-232090		379	22-235961		352	24-000857	B36-0085	740
22-223401		385	22-227997		296	22-232106		379	22-235985		351	24-000857	B36-0085	741
22-223401		386	22-227997		298	22-232120		379	22-235985		352	24-000857	B36-0085	742
22-223401		402	22-227997		299	22-232137		379	22-235992		351	24-000857	B36-0085	745
22-223425		385	22-227997		300	22-232229		385	22-235992		352	24-000918	B46-0091	491
22-223425		386	22-228000		231	22-232229		402	22-236043		617	24-000918	B46-0091	729
22-223425		402	22-228000		232	22-232236		385	22-236067		617	24-000925	B46-0092	181
22-223432		385	22-228017		212	22-232236		402	22-236074		617	24-000925	B46-0092	218
22-223432		386	22-228017		213	22-232410		205	22-236098		617	24-000925	B46-0092	219
22-223432		402	22-228017		214	22-232427		205	22-236135		478	24-000925	B46-0092	315
22-223456		335	22-228017		253	22-232465		206	22-236142		478	24-000925	B46-0092	524
22-223463		335	22-228017		254	22-232472		206	22-236166		478	24-000925	B46-0092	525
22-223470		215	22-228017		255	22-232496		491	22-236173		478	24-000925	B46-0092	527
22-223470		216	22-228017		580	22-232502		491	22-236203		532	24-000925	B46-0092	528
22-223470		604	22-228017		581	22-232526		488	22-236203		739	24-000925	B46-0092	530
22-223616		602	22-228017		582	22-232526		489	22-236210		532	24-000925	B46-0092	710
22-223951		436	22-228062		366	22-232526		555	22-236210		739	24-000925	B46-0092	711
22-223951		437	22-228109		366	22-232526		624	22-236234		532	24-000925	B46-0092	712
22-223951		438	22-228116		366	22-232526		625	22-236234		539	24-000970	B36-0097	183
22-223951		452	22-228123		366	22-232533		488	22-236241		532	24-000970	B36-0097	184
22-22														



# New order number – Old order number

New	Old	Page	New	Old	Page	New	Old	Page	New	Old	Page	New	Old	Page
24-001618	B36-0161	596	24-004862	B36-0486	530	24-007504	B36-0750	311	24-010474	B46-1047	313	24-013840	B36-1384	387
24-001618	B36-0161	597	24-004862	B36-0486	710	24-007504	B36-0750	655	24-010894	B36-1089	323	24-013857	B36-1385	407
24-001670	B46-0167	585	24-004862	B36-0486	711	24-007504	B36-0750	878	24-010993	B46-1099	480	24-013857	B36-1385	408
24-001670	B46-0167	586	24-004862	B36-0486	712	24-007641	B46-0764	257	24-011006	B46-1100	478	24-013857	B36-1385	412
24-001670	B46-0167	587	24-004862	B36-0486	713	24-007672	B46-0767	258	24-011006	B46-1100	480	24-013857	B36-1385	413
24-001670	B46-0167	596	24-004862	B36-0486	714	24-007733	B46-0773	257	24-011020	B46-1102	222	24-013857	B36-1385	414
24-001694	B46-0169	586	24-004930	B46-0493	176	24-007733	B46-0773	258	24-011044	B46-1104	164	24-013895	B36-1389	408
24-001694	B46-0169	587	24-004930	B46-0493	322	24-008020	B46-0802	147	24-011044	B46-1104	168	24-013895	B36-1389	413
24-001793	B46-0179	596	24-004930	B46-0493	323	24-008037	B46-0803	158	24-011044	B46-1104	170	24-013901	B36-1390	387
24-001861	B46-0186	343	24-004930	B46-0493	521	24-008136	B46-0813	158	24-011044	B46-1104	175	24-013932	B46-1393	181
24-001960	B46-0196	343	24-004930	B46-0493	523	24-008198	B46-0819	159	24-011044	B46-1104	176	24-013932	B46-1393	220
24-001984	B46-0198	476	24-004930	B46-0493	524	24-008198	B46-0819	160	24-011044	B46-1104	313	24-013932	B46-1393	315
24-002288	B36-0228	179	24-004930	B46-0493	732	24-008204	B46-0820	864	24-011105	B46-1110	342	24-013932	B46-1393	524
24-002431	B46-0243	361	24-005012	B36-0501	427	24-008303	B46-0830	864	24-011105	B46-1110	533	24-013932	B46-1393	525
24-002431	B46-0243	362	24-005043	B46-0504	434	24-008341	B46-0834	852	24-011105	B46-1110	537	24-013932	B46-1393	527
24-002431	B46-0243	363	24-005043	B46-0504	435	24-008341	B46-0834	852	24-011105	B46-1110	728	24-013932	B46-1393	528
24-002455	B36-0245	362	24-005043	B46-0504	600	24-008341	B46-0834	851	24-011105	B46-1110	743	24-013932	B46-1393	530
24-002455	B36-0245	363	24-005043	B46-0504	601	24-008341	B46-0834	852	24-011167	B46-1116	472	24-013932	B46-1393	542
24-002479	B46-0247	702	24-005067	B46-0506	426	24-008372	B46-0837	784	24-011211	B46-1121	175	24-013932	B46-1393	543
24-002486	B46-0248	702	24-005074	B36-0507	426	24-008372	B46-0837	812	24-011211	B46-1121	585	24-013932	B46-1393	710
24-002509	B46-0250	347	24-005111	B46-0511	426	24-008372	B46-0837	851	24-011259	B46-1125	706	24-013932	B46-1393	711
24-002509	B46-0250	677	24-005111	B46-0511	427	24-008372	B46-0837	852	24-011266	B46-1126	706	24-013932	B46-1393	712
24-002530	B46-0253	361	24-005111	B46-0511	430	24-008716	B46-0871	258	24-011310	B46-1131	179	24-013932	B46-1393	713
24-002530	B46-0253	362	24-005142	B46-0514	434	24-008723	B46-0872	257	24-011327	B46-1132	702	24-013932	B46-1393	714
24-002530	B46-0253	363	24-005142	B46-0514	435	24-008723	B46-0872	258	24-011358	B36-1135	323	24-013932	B46-1393	730
24-002561	B46-0256	702	24-005142	B46-0514	600	24-008839	B46-0883	343	24-011365	B36-1136	323	24-013932	B46-1393	731
24-002585	B46-0258	702	24-005142	B46-0514	601	24-008839	B46-0883	491	24-011396	B46-1139	708	24-014052	B36-1405	387
24-002608	B46-0260	347	24-005166	B60-0516	426	24-008839	B46-0883	531	24-011402	B46-1140	708	24-014106	B46-1410	172
24-002608	B46-0260	677	24-005241	B36-0524	430	24-008938	B46-0893	491	24-011419	B46-1141	181	24-014106	B46-1410	173
24-002837	B46-0283	772	24-005258	B36-0525	409	24-008938	B46-0893	511	24-011488	B46-1148	150	24-014120	B46-1412	171
24-002899	B46-0289	765	24-005258	B36-0525	410	24-008938	B46-0893	531	24-011754	B46-1175	2	24-014120	B46-1412	172
24-002936	B46-0293	772	24-005265	B36-0526	409	24-008938	B46-0893	537	24-011761	B46-1176	2	24-014120	B46-1412	173
24-002967	B46-0296	765	24-005265	B36-0526	410	24-008938	B46-0893	728	24-011778	B46-1177	179	24-014120	B46-1412	313
24-002967	B46-0296	766	24-005272	B36-0527	409	24-008938	B46-0893	743	24-011785	B46-1178	179	24-014137	B46-1413	171
24-003100	B46-0310	322	24-005272	B36-0527	425	24-008938	B46-0893	754	24-011839	B36-1183	427	24-014137	B46-1413	172
24-003100	B46-0310	367	24-005272	B36-0527	429	24-009089	B46-0908	176	24-011846	B46-1184	426	24-014137	B46-1413	173
24-003100	B46-0310	683	24-005289	B36-0528	411	24-009089	B46-0908	322	24-011846	B46-1184	427	24-014137	B46-1413	313
24-003100	B46-0310	684	24-005289	B36-0528	412	24-009089	B46-0908	323	24-011877	B46-1187	702	24-014175	B36-1417	781
24-003179	B46-0317	343	24-005296	B36-0529	429	24-009089	B46-0908	342	24-011884	B46-1188	702	24-014298	B46-1429	95
24-003179	B46-0317	693	24-005340	B46-0534	426	24-009089	B46-0908	523	24-011990	B36-1199	1	24-014304	B46-1430	95
24-003179	B46-0317	694	24-005357	B46-0535	409	24-009089	B46-0908	524	24-011990	B36-1199	335	24-014441	B46-1444	222
24-003193	B46-0319	374	24-005357	B46-0535	410	24-009089	B46-0908	731	24-012003	B36-1200	1	24-014458	B46-1445	222
24-003193	B46-0319	379	24-005364	B46-0536	409	24-009089	B46-0908	732	24-012003	B36-1200	335	24-014533	B46-1453	173
24-003193	B46-0319	690	24-005364	B46-0536	410	24-009188	B46-0918	176	24-012140	B46-1214	382	24-014533	B46-1453	174
24-003193	B46-0319	692	24-005371	B46-0537	409	24-009188	B46-0918	322	24-012157	B46-1215	322	24-014533	B46-1453	176
24-003193	B46-0319	694	24-005371	B46-0537	425	24-009188	B46-0918	342	24-012157	B46-1215	367	24-014533	B46-1453	177
24-003971	B46-0397	630	24-005371	B46-0537	429	24-009188	B46-0918	491	24-012157	B46-1215	683	24-014533	B46-1453	185
24-004107	B46-0410	480	24-005388	B46-0538	411	24-009188	B46-0918	524	24-012157	B46-1215	684	24-014533	B46-1453	186
24-004206	B46-0420	480	24-005388	B46-0538	412	24-009188	B46-0918	531	24-012164	B46-1216	322	24-014670	B46-1467	470
24-004237	B36-0423	340	24-005395	B46-0539	429	24-009188	B46-0918	731	24-012164	B46-1216	367	24-014687	B46-1468	702
24-004237	B36-0423	341	24-005494	B46-0549	249	24-009232	B46-0923	187	24-012164	B46-1216	684	24-014687	B46-1468	708
24-004244	B46-0424	470	24-005494	B46-0549	311	24-009232	B46-0923	314	24-012171	B46-1217	475	24-014687	B46-1468	854
24-004374	B46-0437	322	24-006071	B46-0607	137	24-009294	B46-0929	163	24-012218	B46-1221	138	24-014694	B46-1469	708
24-004374	B46-0437	367	24-006088	B46-0608	136	24-009294	B46-0929	164	24-012218	B46-1221	140	24-014700	B36-1470	387
24-004374	B46-0437	683	24-006088	B46-0608	147	24-009294	B46-0929	168	24-012393	B46-1239	343	24-014700	B36-1470	408
24-004374	B46-0437	684	24-006125	B46-0612	104	24-009294	B46-0929	175	24-012454	B46-1245	479	24-014700	B36-1470	409
24-004435	B36-0443	355	24-006200	B46-0620	817	24-009294	B46-0929	176	24-012454	B46-1245	487	24-014700	B36-1470	412
24-004435	B36-0443	356	24-006309	B46-0630	859	24-009294	B46-0929	182	24-012478	B46-1247	138	24-014700	B36-1470	413
24-004435	B36-0443	357	24-006347	B46-0634	817	24-009294	B46-0929	183	24-012478	B46-1247	139	24-014700	B36-1470	414
24-004459	B36-0445	356	24-006347	B46-0634	859	24-009331	B46-0933	187	24-012577	B46-1257	701	24-014700	B36-1470	415
24-004473	B46-0447	355	24-006514	B46-0651	820	24-009331	B46-0933	314	24-012669	B46-1266	480	24-014700	B36-1470	416
24-004473	B46-0447	356	24-006521	B46-0652	820	24-009492	B36-0949	163	24-012676	B46-1267	480	24-014724	B46-1472	484
24-004473	B46-0447	357	24-006552	B36-0655	786	24-009492	B36-0949	182	24-012744	B36-1274	767	24-014731	B46-1473	484
24-004534	B36-0453	355	24-006559	B36-0656	785	24-009492	B36-0949	183	24-012744	B36-1274	768	24-014748	B46-1474	484
24-004534	B36-0453	356	24-006569	B36-0656	787	24-009669	B46-0966	597	24-012744	B36-1274	769	24-014779	B46-1477	703
24-004534	B36-0453	357	24-006569	B36-0656	813	24-009676	B46-0967	586	24-012744	B36-1274	770	24-014786	B46-1478	703
24-004541	B46-0454	462	24-006569	B36-0656	874	24-009676	B46-0967	587	24-012744	B36-1274	771	24-014816	B46-1481	472
24-004565	B46-0456	460	24-006576	B46-0657	784	24-009676	B46-0967	588	24-012744	B36-1274	772	24-014823	B46-1482	472
24-004572	B46-0457	355	24-006576	B46-0657	812	24-009737	B46-0973	586	24-012768	B46-1276	194	24-014847	B46-1484	702
24-004572	B46-0457	356	24-006576	B46-0657	851	24-009737	B46-0973	587	24-012768	B46-1276	208	24-014854	B46-1485	702



# New order number – Old order number

New	Old	Page	New	Old	Page	New	Old	Page	New	Old	Page	New	Old	Page
24-015233	B36-1523	714	24-016063	B46-1606	325	24-016988	B46-1698	174	24-018449	B36-1844	81	24-020749	B36-2074	567
24-015240	B36-1524	652	24-016063	B46-1606	626	24-016988	B46-1698	176	24-018548	B36-1854	390	24-020756	B36-2075	194
24-015240	B36-1524	787	24-016087	B36-1608	323	24-016988	B46-1698	177	24-018548	B36-1854	391	24-020756	B36-2075	208
24-015240	B36-1524	790	24-016087	B36-1608	324	24-016988	B46-1698	185	24-018555	B36-1855	390	24-020756	B36-2075	556
24-015240	B36-1524	795	24-016087	B36-1608	325	24-016988	B46-1698	336	24-018555	B36-1855	391	24-020756	B36-2075	557
24-015240	B36-1524	858	24-016087	B36-1608	626	24-017015	B46-1701	620	24-018555	B36-1855	403	24-020763	B46-2076	280
24-015257	B36-1525	108	24-016094	B36-1609	323	24-017015	B46-1701	621	24-018562	B36-1856	389	24-020763	B46-2076	487
24-015257	B36-1525	111	24-016094	B36-1609	324	24-017015	B46-1701	622	24-018562	B36-1856	391	24-020770	B46-2077	280
24-015257	B36-1525	113	24-016094	B36-1609	325	24-017015	B46-1701	623	24-018579	B36-1857	389	24-020770	B46-2077	479
24-015264	B36-1526	108	24-016094	B36-1609	626	24-017060	B36-1706	428	24-018579	B36-1857	391	24-020770	B46-2077	480
24-015264	B36-1526	111	24-016100	B46-1610	321	24-017077	B46-1707	428	24-018579	B36-1857	402	24-020770	B46-2077	487
24-015264	B36-1526	113	24-016100	B46-1610	510	24-017176	B46-1717	620	24-018579	B36-1857	403	24-020787	B46-2078	677
24-015264	B36-1526	114	24-016100	B46-1610	542	24-017176	B46-1717	621	24-018586	B46-1858	223	24-020794	B36-2079	30
24-015271	B46-1527	150	24-016100	B46-1610	543	24-017176	B46-1717	622	24-018586	B46-1858	345	24-020794	B36-2079	34
24-015288	B46-1528	342	24-016100	B46-1610	728	24-017176	B46-1717	623	24-018593	B46-1859	435	24-020794	B36-2079	62
24-015288	B46-1528	533	24-016100	B46-1610	730	24-017183	B46-1718	620	24-018593	B46-1859	601	24-020794	B36-2079	65
24-015288	B46-1528	538	24-016100	B46-1610	731	24-017183	B46-1718	621	24-018609	B46-1860	435	24-020794	B36-2079	93
24-015288	B46-1528	728	24-016124	B36-1612	407	24-017183	B46-1718	622	24-018609	B46-1860	601	24-020794	B36-2079	827
24-015288	B46-1528	743	24-016124	B36-1612	408	24-017183	B46-1718	623	24-018616	B36-1861	223	24-020794	B36-2079	829
24-015295	B36-1529	652	24-016124	B36-1612	409	24-017213	B36-1721	323	24-018616	B36-1861	345	24-020800	B36-2080	30
24-015295	B36-1529	781	24-016124	B36-1612	412	24-017213	B36-1721	324	24-018630	B36-1863	345	24-020800	B36-2080	34
24-015295	B36-1529	787	24-016124	B36-1612	413	24-017213	B36-1721	325	24-018647	B46-1864	345	24-020817	B36-2081	30
24-015295	B36-1529	790	24-016124	B36-1612	414	24-017213	B36-1721	625	24-018692	B46-1869	364	24-020817	B36-2081	34
24-015295	B36-1529	795	24-016155	B46-1615	306	24-017220	B36-1722	323	24-018692	B46-1869	365	24-020817	B36-2081	62
24-015295	B36-1529	858	24-016179	B46-1617	306	24-017220	B36-1722	324	24-018708	B46-1870	364	24-020817	B36-2081	65
24-015356	B36-1535	427	24-016179	B46-1617	308	24-017220	B36-1722	325	24-018708	B46-1870	365	24-020817	B36-2081	93
24-015363	B46-1536	427	24-016186	B46-1618	304	24-017220	B36-1722	625	24-018739	B46-1873	484	24-020817	B36-2081	827
24-015370	B36-1537	428	24-016186	B46-1618	305	24-017237	B46-1723	323	24-018739	B46-1873	485	24-020817	B36-2081	829
24-015387	B46-1538	428	24-016186	B46-1618	306	24-017237	B46-1723	324	24-018753	B36-1875	704	24-020824	B36-2082	30
24-015479	B46-1547	588	24-016186	B46-1618	308	24-017237	B46-1723	325	24-018999	B46-1899	169	24-020824	B36-2082	34
24-015479	B46-1547	589	24-016193	B46-1619	77	24-017237	B46-1723	625	24-019118	B46-1911	865	24-020879	B46-2087	173
24-015509	B46-1550	382	24-016193	B46-1619	782	24-017275	B46-1727	435	24-019156	B36-1915	617	24-020879	B46-2087	176
24-015523	B46-1552	315	24-016193	B46-1619	841	24-017275	B46-1727	601	24-019163	B46-1916	471	24-020879	B46-2087	177
24-015523	B46-1552	316	24-016193	B46-1619	842	24-017282	B46-1728	435	24-019163	B46-1916	484	24-021050	B46-2105	336
24-015523	B46-1552	493	24-016247	B46-1624	211	24-017282	B46-1728	601	24-019163	B46-1916	485	24-021074	B46-2107	485
24-015523	B46-1552	494	24-016353	B46-1635	435	24-017343	B46-1734	435	24-020251	B46-2025	365	24-021081	B46-2108	485
24-015523	B46-1552	496	24-016353	B46-1635	601	24-017350	B46-1735	588	24-020268	B46-2026	365	24-021098	B46-2109	470
24-015523	B46-1552	497	24-016360	B46-1636	435	24-017350	B46-1735	589	24-020275	B36-2027	13	24-021104	B46-2110	470
24-015523	B46-1552	715	24-016360	B46-1636	601	24-017381	B46-1738	343	24-020275	B36-2027	105	24-021111	B46-2111	470
24-015523	B46-1552	716	24-016377	B36-1637	261	24-017381	B46-1738	532	24-020275	B36-2027	106	24-021142	B46-2114	1
24-015523	B46-1552	717	24-016377	B36-1637	263	24-017381	B46-1738	740	24-020275	B36-2027	107	24-021142	B46-2114	324
24-015530	B36-1553	781	24-016384	B46-1638	605	24-017398	B46-1739	343	24-020275	B36-2027	110	24-021197	B36-2119	636
24-015554	B46-1555	542	24-016391	B36-1639	605	24-017398	B46-1739	532	24-020282	B36-2028	13	24-021197	B36-2119	641
24-015554	B46-1555	543	24-016407	B36-1640	760	24-017398	B46-1739	740	24-020282	B36-2028	105	24-021197	B36-2119	842
24-015554	B46-1555	730	24-016407	B36-1640	761	24-017428	B46-1742	469	24-020282	B36-2028	106	24-021197	B36-2119	844
24-015554	B46-1555	731	24-016407	B36-1640	762	24-017435	B46-1743	470	24-020282	B36-2028	110	24-021197	B36-2119	845
24-015714	B46-1571	2	24-016407	B36-1640	769	24-017442	B46-1744	471	24-020336	B46-2033	173	24-021203	B36-2120	705
24-015714	B46-1571	3	24-016407	B36-1640	770	24-017473	B36-1747	328	24-020336	B46-2033	174	24-021210	B36-2121	705
24-015714	B46-1571	4	24-016476	B36-1647	181	24-017480	B36-1748	328	24-020336	B46-2033	176	24-021227	B36-2122	636
24-015714	B46-1571	228	24-016476	B36-1647	495	24-017497	B46-1749	328	24-020336	B46-2033	177	24-021227	B36-2122	641
24-015714	B46-1571	229	24-016476	B36-1647	497	24-017503	B46-1750	475	24-020336	B46-2033	185	24-021227	B36-2122	842
24-015714	B46-1571	247	24-016476	B36-1647	529	24-017503	B46-1750	476	24-020336	B46-2033	186	24-021227	B36-2122	844
24-015714	B46-1571	248	24-016476	B36-1647	714	24-017534	B46-1753	260	24-020411	B46-2041	187	24-021227	B36-2122	845
24-015714	B46-1571	358	24-016476	B36-1647	716	24-017534	B46-1753	261	24-020428	B46-2042	187	24-021289	B46-2128	478
24-015738	B46-1573	59	24-016476	B36-1647	717	24-017534	B46-1753	262	24-020428	B46-2042	188	24-021289	B46-2128	480
24-015738	B46-1573	60	24-016483	B36-1648	181	24-017534	B46-1753	263	24-020435	B46-2043	173	24-021289	B46-2128	702
24-015738	B46-1573	89	24-016483	B36-1648	495	24-017534	B46-1753	286	24-020435	B46-2043	174	24-021289	B46-2128	854
24-015738	B46-1573	90	24-016483	B36-1648	497	24-017701	B46-1770	342	24-020435	B46-2043	176	24-021319	B46-2131	304
24-015738	B46-1573	91	24-016483	B36-1648	529	24-017701	B46-1770	533	24-020435	B46-2043	177	24-021319	B46-2131	452
24-015769	B46-1576	59	24-016483	B36-1648	714	24-017701	B46-1770	535	24-020459	B46-2045	340	24-021326	B46-2132	304
24-015769	B46-1576	60	24-016483	B36-1648	717	24-017701	B46-1770	729	24-020473	B46-2047	789	24-021326	B46-2132	452
24-015769	B46-1576	89	24-016582	B46-1658	542	24-017756	B36-1775	336	24-020480	B46-2048	789	24-021333	B46-2133	304
24-015769	B46-1576	90	24-016582	B46-1658	543	24-017763	B36-1776	336	24-020503	B36-2050	78	24-021333	B46-2133	452
24-015769	B46-1576	91	24-016582	B46-1658	730	24-017787	B46-1778	382	24-020503	B36-2050	79	24-021340	B46-2134	304
24-015776	B46-1577	260	24-016582	B46-1658	731	24-017794	B46-1779	382	24-020503	B36-2050	80	24-021340	B46-2134	452
24-015776	B46-1577	261	24-016629	B46-1662	767	24-017824	B46-1782	342	24-020503	B36-2050	81	24-021357	B36-2135	304
24-015776	B46-1577	262	24-016629	B46-1662	768	24-017824	B46-1782	481	24-020503	B36-2050	83	24-021357	B36-2135	452
24-015776	B46-1577	263	24-016629	B46-1662	769	24-017824	B46-1782	482	24-020503	B36-2050	84	24-021364	B46-2136	170
24-015776	B46-1577	286	24-016629	B46-1662	770	24-017831	B46-1783	365	24-020510	B36-2051	78	24-021364	B46-2136	313
24-015837	B46-1583	341	24-016629	B46-1662	771	24-017848	B46-1784	365	24-020510	B36-2051	79			



## New order number – Old order number

New	Old	Page	New	Old	Page	New	Old	Page	New	Old	Page	New	Old	Page
24-022361		311	24-024662	BE5-2466	238	24-026246	BE3-2624	653	24-027830	BE5-2783	720	24-060349	BE5-6034	75
24-022477	B46-2247	188	24-024662	BE5-2466	360	24-026246	BE3-2624	775	24-027830	BE5-2783	721	24-060349	BE5-6034	646
24-022477	B46-2247	314	24-024679	BE5-2467	227	24-026246	BE3-2624	791	24-027830	BE5-2783	722	24-060349	BE5-6034	653
24-022484	B46-2248	188	24-024679	BE5-2467	237	24-026246	BE3-2624	819	24-027847	BE5-2784	169	24-060349	BE5-6034	660
24-022484	B46-2248	314	24-024693	BE3-2469	477	24-026246	BE3-2624	871	24-027847	BE5-2784	501	24-060349	BE5-6034	662
24-022576	B36-2257	430	24-024785		305	24-026246	BE3-2624	875	24-027847	BE5-2784	503	24-060349	BE5-6034	775
24-022583	B46-2258	534	24-024792		305	24-026246	BE3-2624	876	24-027847	BE5-2784	721	24-060349	BE5-6034	777
24-022583	B46-2258	742	24-024815	BE5-2481	180	24-026314	BE5-2631	602	24-027847	BE5-2784	722	24-060349	BE5-6034	791
24-022590	B46-2259	533	24-024846	BE5-2484	182	24-026413	BE5-2641	267	24-027960	BE3-2796	4	24-060349	BE5-6034	794
24-022590	B46-2259	535	24-024846	BE5-2484	218	24-026413	BE5-2641	279	24-027960	BE3-2796	5	24-060356	BE5-6035	17
24-022590	B46-2259	743	24-024846	BE5-2484	219	24-026413	BE5-2641	286	24-027960	BE3-2796	7	24-060356	BE5-6035	74
24-022606	B46-2260	534	24-024846	BE5-2484	220	24-026505	BE5-2650	611	24-027960	BE3-2796	11	24-060356	BE5-6035	75
24-022606	B46-2260	742	24-024846	BE5-2484	315	24-026512	BE5-2651	609	24-027977	BE3-2797	4	24-060356	BE5-6035	646
24-022989	BE5-2298	521	24-024846	BE5-2484	524	24-026512	BE5-2651	610	24-027977	BE3-2797	5	24-060356	BE5-6035	653
24-022989	BE5-2298	737	24-024846	BE5-2484	527	24-026529	BE5-2652	154	24-027977	BE3-2797	7	24-060356	BE5-6035	661
24-023139	B46-2313	558	24-024846	BE5-2484	528	24-026604	BE5-2660	264	24-027977	BE3-2797	11	24-060356	BE5-6035	662
24-023139	B46-2313	559	24-024846	BE5-2484	530	24-026604	BE5-2660	265	24-028004	BE3-2800	662	24-060356	BE5-6035	775
24-023139	B46-2313	571	24-024846	BE5-2484	710	24-026628	BE5-2662	344	24-028011	BE3-2801	662	24-060356	BE5-6035	777
24-023368	BE5-2336	329	24-024846	BE5-2484	711	24-026703	BE5-2670	189	24-028028	BE5-2802	365	24-060356	BE5-6035	791
24-023368	BE5-2336	330	24-024846	BE5-2484	712	24-026727	BE5-2672	189	24-028035	BE5-2803	365	24-060356	BE5-6035	794
24-023375	BE5-2337	329	24-024877	BE5-2487	495	24-026758	BE5-2675	702	24-028066	BE3-2806	635	24-060417	BE5-6041	625
24-023375	BE5-2337	330	24-024877	BE5-2487	525	24-026758	BE5-2675	854	24-028066	BE3-2806	818	24-060424	BE5-6042	625
24-023382	BE5-2338	333	24-024877	BE5-2487	527	24-026895	BE5-2689	264	24-028073	BE3-2807	635	24-060431	BE5-6043	480
24-023399	BE5-2339	333	24-024884	BE5-2488	262	24-026895	BE5-2689	265	24-028073	BE3-2807	818	24-060448	BE5-6044	480
24-023405	BE5-2340	1	24-024921	BE3-2492	344	24-026970	BE3-2697	115	24-028172	BE3-2817	156	24-060462	BE5-6046	362
24-023405	BE5-2340	334	24-025027	BE5-2502	173	24-026970	BE3-2697	117	24-028288	BE5-2828	141	24-060479	BE5-6047	362
24-023412	BE5-2341	1	24-025027	BE5-2502	189	24-026970	BE3-2697	118	24-028295	BE5-2829	141	24-060486	BE5-6048	365
24-023412	BE5-2341	334	24-025027	BE5-2502	315	24-026970	BE3-2697	119	24-028318	BE5-2831	521	24-060493	BE5-6049	365
24-023429	BE5-2342	475	24-025256	BE3-2525	431	24-026970	BE3-2697	120	24-028318	BE5-2831	737	24-060554	BE3-6055	625
24-023443	BE5-2344	482	24-025263	BE3-2526	431	24-026970	BE3-2697	121	24-028929	BE3-2892	559	24-060561	BE3-6056	625
24-023450	BE5-2345	479	24-025287	BE5-2528	453	24-026970	BE3-2697	160	24-028929	BE3-2892	560	24-060608	BE3-6060	209
24-023528	BE5-2352	706	24-025324	BE3-2532	62	24-026987	BE3-2698	13	24-028929	BE3-2892	562	24-060608	BE3-6060	210
24-023719	BE5-2371	1	24-025324	BE3-2532	93	24-026987	BE3-2698	14	24-029025	BE5-2902	184	24-060615	BE5-6061	143
24-023719	BE5-2371	324	24-025324	BE3-2532	827	24-026987	BE3-2698	115	24-029025	BE5-2902	313	24-060646	BE3-6064	239
24-023726	BE3-2372	345	24-025324	BE3-2532	829	24-026987	BE3-2698	116	24-029032	BE5-2903	184	24-060646	BE3-6064	877
24-023733	BE5-2373	345	24-025331	BE3-2533	62	24-026987	BE3-2698	118	24-029032	BE5-2903	313	24-060646	BE3-6064	878
24-023740	BE3-2374	345	24-025331	BE3-2533	93	24-026987	BE3-2698	120	24-029056	BE5-2905	184	24-060653	BE5-6065	13
24-023757	BE5-2375	345	24-025331	BE3-2533	827	24-026987	BE3-2698	121	24-029056	BE5-2905	313	24-060653	BE5-6065	105
24-023863	BE3-2386	155	24-025331	BE3-2533	829	24-026987	BE3-2698	160	24-029063	BE5-2906	184	24-060653	BE5-6065	106
24-023900	BE3-2390	178	24-025386	BE5-2538	630	24-026994	BE3-2699	65	24-029063	BE5-2906	313	24-060813	BE5-6081	170
24-023900	BE3-2390	179	24-025386	BE5-2538	631	24-027007	BE3-2700	65	24-029070	BE5-2907	184	24-060813	BE5-6081	184
24-023900	BE3-2390	320	24-025409	BE5-2540	591	24-027045	BE3-2704	244	24-029070	BE5-2907	313	24-060813	BE5-6081	185
24-023900	BE3-2390	513	24-025430	BE3-2543	17	24-027083	BE3-2708	628	24-02913	BE5-2951	681	24-060813	BE5-6081	186
24-023900	BE3-2390	514	24-025430	BE3-2543	660	24-027090	BE3-2709	628	24-029636	BE5-2963	349	24-060813	BE5-6081	187
24-023900	BE3-2390	516	24-025430	BE3-2543	661	24-027090	BE3-2709	629	24-029643	BE5-2964	349	24-060813	BE5-6081	188
24-023900	BE3-2390	540	24-025447	BE3-2544	17	24-027113	BE5-2711	286	24-029728	BE3-2972	175	24-060813	BE5-6081	313
24-023900	BE3-2390	733	24-025447	BE3-2544	661	24-027182	BE5-2718	155	24-029759	BE5-2975	168	24-060813	BE5-6081	314
24-023900	BE3-2390	741	24-025508	BE5-2550	225	24-027182	BE5-2718	156	24-029759	BE5-2975	169	24-060820	BE5-6082	184
24-023900	BE3-2390	742	24-025515	BE3-2551	191	24-027243	BE5-2724	108	24-029759	BE5-2975	179	24-060820	BE5-6082	185
24-023900	BE3-2390	745	24-025515	BE3-2551	544	24-027243	BE5-2724	111	24-029759	BE5-2975	180	24-060820	BE5-6082	186
24-023917	BE3-2391	178	24-025515	BE3-2551	545	24-027243	BE5-2724	113	24-029766	BE5-2976	168	24-060820	BE5-6082	187
24-023917	BE3-2391	179	24-025515	BE3-2551	546	24-027243	BE5-2724	114	24-029766	BE5-2976	169	24-060820	BE5-6082	313
24-023917	BE3-2391	320	24-025515	BE3-2551	746	24-027250	BE5-2725	108	24-029766	BE5-2976	179	24-060905	BE3-6090	416
24-023917	BE3-2391	513	24-025515	BE3-2551	747	24-027250	BE5-2725	111	24-029766	BE5-2976	180	24-060905	BE3-6090	419
24-023917	BE3-2391	514	24-025515	BE3-2551	749	24-027250	BE5-2725	113	24-029773	BE5-2977	168	24-060950	BE5-6095	267
24-023917	BE3-2391	516	24-025522	BE3-2552	544	24-027250	BE5-2725	114	24-029773	BE5-2977	169	24-060950	BE5-6095	279
24-023917	BE3-2391	540	24-025522	BE3-2552	545	24-027267	BE5-2726	709	24-029773	BE5-2977	179	24-060950	BE5-6095	286
24-023917	BE3-2391	733	24-025522	BE3-2552	547	24-027274	BE5-2727	709	24-029773	BE5-2977	180	24-060967	BE5-6096	143
24-023917	BE3-2391	741	24-025522	BE3-2552	748	24-027304	BE5-2730	155	24-029780	BE5-2978	168	24-060974	BE5-6097	9
24-023917	BE3-2391	742	24-025652	BE5-2565	180	24-027304	BE5-2730	156	24-029780	BE5-2978	169	24-060981	BE5-6098	9
24-023917	BE3-2391	745	24-025683	BE5-2568	174	24-027342	BE5-2734	365	24-029780	BE5-2978	179	24-060981	BE5-6098	9
24-024051	BE5-2405	187	24-025683	BE5-2568	177	24-027359	BE5-2735	365	24-029780	BE5-2978	180	24-061001	BE5-6100	9
24-024051	BE5-2405	188	24-025706	BE5-2570	180	24-027366	BE5-2736	219	24-029810	BE5-2981	346	24-061025	BE5-6102	349
24-024068	BE5-2406	175	24-025768	BE3-2576	95	24-027397	BE5-2739	365	24-029858	BE5-2985	432	24-061032	BE5-6103	349
24-024068	BE5-2406	585	24-025775	BE3-2577	95	24-027397	BE5-2739	703	24-029865	BE5-2986	521	24-061308	BE5-6130	589
24-024075	BE5-2407	175	24-025799	BE5-2579	347	24-027403	BE5-2740	365	24-029865	BE5-2986	737	24-061308	BE5-6130	590
24-024075	BE5-2407	585	24-025829	BE5-2582	463	24-027403	BE5-2740	703	24-029896	BE5-2989	191	24-062039	BE3-6203	417
24-024129	BE5-2412	189	24-025836	BE3-2583	463	24-027410	BE5-2741	703	24-029896	BE5-2989	323	24-062046	BE3-6204	417
24-024136	BE5-2413	189	24-025935	BE5-2593	59	24-027434	BE5-2743	365	24-029896	BE5-2989	525	24-062053	BE3-6205	417
24-024167	BE5-2416	187	24-025935	BE5-2593	60	24-027441	BE5-2744	365	24-029896	BE5-2989	755			



# New order number – Old order number

New	Old	Page	New	Old	Page	New	Old	Page	New	Old	Page	New	Old	Page
24-064927	BE5-6492	346	24-066778	BE5-6677	346	24-069052	BE5-6905	422	24-102636	BE5-A263	615	24-110600	BE5-B060	599
24-065009	BE5-6500	168	24-066785	BE5-6678	71	24-069052	BE5-6905	451	24-102636	BE5-A263	616	24-110600	BE5-B060	855
24-065009	BE5-6500	170	24-067263	BE5-6726	345	24-069069	BE3-6906	420	24-102650	BE5-A265	612	24-110754	BE5-B075	272
24-065009	BE5-6500	184	24-067270	BE5-6727	345	24-069069	BE3-6906	451	24-102650	BE5-A265	613	24-111041	BE5-B104	354
24-065009	BE5-6500	188	24-067287	BE3-6728	344	24-069076	BE5-6907	420	24-102650	BE5-A265	616	24-111058	BE5-B105	354
24-065009	BE5-6500	190	24-067379		173	24-069076	BE5-6907	422	24-102667	BE5-A266	246	24-112703	BE5-B270	148
24-065009	BE5-6500	313	24-067379		177	24-069076	BE5-6907	451	24-102674	BE5-A267	246	24-112727	BE5-B272	148
24-065009	BE5-6500	314	24-067379		314	24-069083	BE3-6908	406	24-103251	BE3-A325	453	24-113205	BE5-B320	341
24-065085	BE5-6508	62	24-067379		315	24-069083	BE3-6908	420	24-103251	BE3-A325	454	24-113212	BE5-B321	341
24-065085	BE5-6508	65	24-067430	BE3-6743	344	24-069083	BE3-6908	451	24-103336	BE5-A333	190	24-113359	VNE-B335	590
24-065085	BE5-6508	93	24-067447	BE3-6744	344	24-069243	BE5-6924	699	24-103336	BE5-A333	342	24-113359	VNE-B335	591
24-065092	BE5-6509	62	24-067454	BE5-6745	344	24-069243	BE5-6924	700	24-103336	BE5-A333	629	24-113366	BE5-B336	434
24-065092	BE5-6509	65	24-067461	BE5-6746	463	24-069243	BE5-6924	701	24-103336	BE5-A333	190	24-113366	BE5-B336	435
24-065092	BE5-6509	829	24-067478	BE3-6747	463	24-069250	BE5-6925	699	24-103336	BE5-A333	629	24-113366	BE5-B336	600
24-065092	BE5-6509	831	24-067577	BE3-6757	117	24-069250	BE5-6925	700	24-103350	BE5-A335	190	24-113366	BE5-B336	601
24-065092	BE5-6509	833	24-067713	BE5-6771	344	24-069250	BE5-6925	701	24-103350	BE5-A335	342	24-113373	BE5-B337	434
24-065108	BE5-6510	62	24-067720	BE5-6772	344	24-069274	BE5-6927	225	24-103527	BE5-A352	277	24-113373	BE5-B337	435
24-065108	BE5-6510	65	24-067782	BE5-6778	344	24-069281	BE5-6928	225	24-103527	BE5-A352	632	24-113373	BE5-B337	600
24-065108	BE5-6510	93	24-067799	BE3-6779	344	24-069366	BE3-6936	387	24-103527	BE5-A352	853	24-113373	BE5-B337	601
24-065115	BE5-6511	62	24-067829	BE3-6782	383	24-069533	BE5-6953	833	24-103534	BE5-A353	277	24-113441	BE3-B344	431
24-065115	BE5-6511	65	24-067898	BE3-6789	15	24-069601	BE5-6960	164	24-103534	BE5-A353	632	24-113465	BE3-B346	431
24-065115	BE5-6511	829	24-067898	BE3-6789	16	24-069601	BE5-6960	166	24-103534	BE5-A353	853	24-113465	BE3-B346	432
24-065115	BE5-6511	831	24-067898	BE3-6789	639	24-069601	BE5-6960	167	24-103565	BE3-A356	268	24-114240	BE5-B424	331
24-065115	BE5-6511	834	24-067898	BE3-6789	643	24-069601	BE5-6960	231	24-103565	BE3-A356	368	24-114240	BE5-B424	332
24-065122	BE5-6512	30	24-067898	BE3-6789	644	24-069601	BE5-6960	539	24-103596	BE3-A359	268	24-114455	BE5-B445	345
24-065122	BE5-6512	34	24-067898	BE3-6789	645	24-069601	BE5-6960	548	24-103596	BE3-A359	368	24-114462	BE5-B446	345
24-065122	BE5-6512	671	24-067898	BE3-6789	656	24-069601	BE5-6960	549	24-104050	BE5-A405	168	24-114479	BE5-B447	346
24-065122	BE5-6512	829	24-067898	BE3-6789	657	24-069601	BE5-6960	552	24-104050	BE5-A405	173	24-114486	BE5-B448	346
24-065122	BE5-6512	831	24-067898	BE3-6789	658	24-069601	BE5-6960	744	24-104050	BE5-A405	174	24-114585	BE5-B458	153
24-065122	BE5-6512	833	24-067898	BE3-6789	659	24-069601	BE5-6960	750	24-104050	BE5-A405	176	24-114653	BE5-B465	317
24-065139	BE5-6513	30	24-067898	BE3-6789	846	24-069601	BE5-6960	751	24-104050	BE5-A405	177	24-114653	BE5-B465	318
24-065139	BE5-6513	34	24-067898	BE3-6789	847	24-069601	BE5-6960	753	24-104050	BE5-A405	187	24-114653	BE5-B465	319
24-065139	BE5-6513	671	24-067898	BE3-6789	848	24-069618	BE5-6961	164	24-104050	BE5-A405	188	24-114653	BE5-B465	504
24-065139	BE5-6513	829	24-067898	BE3-6789	876	24-069618	BE5-6961	166	24-104050	BE5-A405	189	24-114653	BE5-B465	505
24-065139	BE5-6513	831	24-067904	BE3-6790	15	24-069618	BE5-6961	167	24-104050	BE5-A405	314	24-114653	BE5-B465	508
24-065139	BE5-6513	833	24-067904	BE3-6790	16	24-069618	BE5-6961	231	24-104050	BE5-A405	315	24-114653	BE5-B465	723
24-065139	BE5-6513	834	24-067904	BE3-6790	639	24-069618	BE5-6961	539	24-104371	BE3-A437	384	24-114653	BE5-B465	724
24-065146	BE5-6514	38	24-067904	BE3-6790	643	24-069618	BE5-6961	548	24-104401	BE3-A440	277	24-114653	BE5-B465	725
24-065146	BE5-6514	41	24-067904	BE3-6790	644	24-069618	BE5-6961	549	24-104616	BE3-A461	384	24-114684	BE5-B468	318
24-065146	BE5-6514	43	24-067904	BE3-6790	645	24-069618	BE5-6961	550	24-104807	BE5-A480	703	24-114684	BE5-B468	319
24-065153	BE5-6515	38	24-067904	BE3-6790	656	24-069618	BE5-6961	552	24-104814	BE5-A481	703	24-114684	BE5-B468	504
24-065153	BE5-6515	41	24-067904	BE3-6790	657	24-069618	BE5-6961	744	24-104906	BE3-A490	156	24-114684	BE5-B468	506
24-065153	BE5-6515	43	24-067904	BE3-6790	658	24-069618	BE5-6961	750	24-104906	BE3-A490	157	24-114684	BE5-B468	508
24-065160	BE5-6516	38	24-067904	BE3-6790	659	24-069618	BE5-6961	751	24-104937	BE3-A493	156	24-114684	BE5-B468	723
24-065160	BE5-6516	42	24-067904	BE3-6790	846	24-069618	BE5-6961	752	24-104937	BE3-A493	157	24-114684	BE5-B468	724
24-065160	BE5-6516	44	24-067904	BE3-6790	847	24-069618	BE5-6961	753	24-105804	BE3-A580	362	24-114684	BE5-B468	725
24-065177	BE5-6517	38	24-067904	BE3-6790	848	24-069687	BE5-6968	569	24-105910	BE3-A591	420	24-114714	BE3-B471	392
24-065177	BE5-6517	42	24-067904	BE3-6790	876	24-100144		706	24-105910	BE3-A591	422	24-114714	BE3-B471	393
24-065177	BE5-6517	44	24-067911	BE5-6791	192	24-100397	BE3-A039	390	24-105910	BE3-A591	450	24-114714	BE3-B471	394
24-065184	BE3-6518	682	24-067911	BE5-6791	230	24-100397	BE3-A039	391	24-105927	BE3-A592	406	24-114714	BE3-B471	395
24-065191	BE3-6519	559	24-067911	BE5-6791	245	24-100403	BE3-A040	390	24-105927	BE3-A592	420	24-114714	BE3-B471	396
24-065191	BE3-6519	560	24-067911	BE5-6791	359	24-100403	BE3-A040	391	24-105927	BE3-A592	450	24-114714	BE3-B471	404
24-065191	BE3-6519	561	24-067928	BE5-6792	192	24-100403	BE3-A040	403	24-105927	BE3-A592	451	24-114714	BE3-B471	405
24-065191	BE3-6519	562	24-067928	BE5-6792	230	24-100427	BE3-A042	387	24-106290	BE3-A629	405	24-115926	BE5-B592	96
24-065276		305	24-067928	BE5-6792	245	24-100441	BE3-A044	408	24-106320	BE3-A632	405	24-115926	BE5-B592	98
24-065276		306	24-067928	BE5-6792	359	24-100441	BE3-A044	412	24-107013	BE5-A701	224	24-115926	BE5-B592	99
24-065276		307	24-067935	BE5-6793	759	24-100441	BE3-A044	413	24-107303	BE5-A730	327	24-115926	BE5-B592	100
24-065276		308	24-067935	BE5-6793	763	24-100441	BE3-A044	414	24-107310	BE5-A731	327	24-115957	BE5-B595	96
24-065283		303	24-067935	BE5-6793	764	24-100458	BE3-A045	417	24-107327	BE5-A732	327	24-115957	BE5-B595	98
24-065283		305	24-067942	BE5-6794	759	24-100465	BE3-A046	417	24-107440	BE5-A744	154	24-115957	BE5-B595	99
24-065283		306	24-067942	BE5-6794	763	24-100540	BE3-A054	416	24-107488	BE5-A748	333	24-115957	BE5-B595	100
24-065283		307	24-067942	BE5-6794	764	24-100540	BE3-A054	417	24-107617		304	24-116244	BE5-B624	487
24-065283		308	24-067966	BE3-6796	687	24-100540	BE3-A054	418	24-107617		305	24-116299	BE5-B629	67
24-065290	BE5-6529	361	24-068116	BE5-6811	590	24-100540	BE3-A054	419	24-107624		305	24-116299	BE5-B629	68
24-065290	BE5-6529	362	24-068116	BE5-6811	591	24-100557	BE3-A055	416	24-107839	BE3-A783	192	24-116299	BE5-B629	94
24-065382	BE5-6538	224	24-068598	BE5-6859	590	24-100557	BE3-A055	417	24-107839	BE3-A783	193	24-116312	BE5-B631	67
24-065405	BE5-6540	361	24-068598	BE5-6859	591	24-100564	BE3-A056	416	24-107938	BE5-A793	327	24-116312	BE5-B631	68
24-065405	BE5-6540	362	24-068604	BE5-6860	201	24-100564	BE3-A056	417	24-107945	BE5-A794	327	24-116312	BE5-B631	94
24-065429	BE5-6542	62	24-068604	BE5-6860	202	24-100571	BE3-A057	416	24-108096	BE5-A809	14	24-118224	BE5-B822	592
24-065429	BE5-6542	93	24-068604	BE5-6860	203	24-100571	BE3-A057	417	24-108096	BE5-A809	152	24-118224	BE5-B822	594
24-065429	BE5-6542	671	24-068604	BE5-6860	568	24-100571	BE3-A057	419	24-108256	BE3-A825	416	24-118248	BE5-B824	592
24-065429	BE5-6542	831	24-068604	BE5-6860	569	24-1005								



# New order number – Old order number

New	Old	Page	New	Old	Page	New	Old	Page	New	Old	Page	New	Old	Page
24-119795	BE5-B979	43	24-132725	BE5-D272	349	24-142311	BE3-E231	458	24-145992	BE5-E599	94	24-169608	BE3-G960	438
24-119795	BE5-B979	47	24-132732	BE5-D273	349	24-142311	BE3-E231	459	24-146135	BE5-E613	763	24-169608	BE3-G960	452
24-119795	BE5-B979	50	24-136709	BE5-D670	363	24-142342	BE3-E234	517	24-146708	BE5-E670	351	24-170659	BE3-H065	157
24-119795	BE5-B979	92	24-136716	BE5-D671	363	24-142342	BE3-E234	517	24-146715	BE5-E671	351	24-170680	BE3-H068	157
24-119795	BE5-B979	639	24-136822	BE5-D682	75	24-142342	BE3-E234	540	24-146944	BE5-E694	72	24-170826	BE3-H082	399
24-119795	BE5-B979	640	24-136822	BE5-D682	76	24-142342	BE3-E234	735	24-146944	BE5-E694	854	24-170826	BE3-H082	401
24-119818	BE5-B981	38	24-136846	BE5-D684	76	24-142342	BE3-E234	736	24-146944	BE5-E694	876	24-171014	BE5-H101	407
24-119818	BE5-B981	42	24-137430		478	24-142342	BE3-E234	745	24-147002	BE5-E700	765	24-171014	BE5-H101	424
24-119818	BE5-B981	44	24-137430		488	24-143318	BE5-E331	99	24-147477	BE5-E747	592	24-171311	BE5-H131	153
24-119818	BE5-B981	47	24-137867	BE5-D786	782	24-143318	BE5-E331	123	24-147477	BE5-E747	593	24-171311	BE5-H131	163
24-119818	BE5-B981	51	24-137874	BE5-D787	782	24-143318	BE5-E331	124	24-147477	BE5-E747	594	24-171472	BE5-H147	354
24-119818	BE5-B981	92	24-138284	BE5-D828	562	24-143318	BE5-E331	128	24-147484	BE5-E748	592	24-171687	BE3-H168	166
24-119818	BE5-B981	639	24-138284	BE5-D828	563	24-143318	BE5-E331	130	24-147484	BE5-E748	593	24-171687	BE3-H168	180
24-119818	BE5-B981	640	24-138284	BE5-D828	564	24-143349	BE5-E334	99	24-147484	BE5-E748	594	24-171687	BE3-H168	191
24-119825	BE5-B982	38	24-138338	BE5-D833	563	24-143349	BE5-E334	123	24-147644	VNE-E764	590	24-171687	BE3-H168	321
24-119825	BE5-B982	42	24-138338	BE5-D833	564	24-143349	BE5-E334	128	24-147644	VNE-E764	591	24-171687	BE3-H168	322
24-119825	BE5-B982	44	24-139106	BE5-D910	193	24-143349	BE5-E334	130	24-151368	BE5-F136	467	24-171687	BE3-H168	509
24-119825	BE5-B982	47	24-139106	BE5-D910	224	24-143639	BE5-E363	278	24-151375	BE5-F137	467	24-171687	BE3-H168	510
24-119825	BE5-B982	51	24-139113	BE5-D911	193	24-143639	BE5-E363	284	24-151627	BE5-F162	305	24-171687	BE3-H168	554
24-119825	BE5-B982	92	24-139113	BE5-D911	224	24-143639	BE5-E363	293	24-152938	BE5-F293	365	24-171687	BE3-H168	726
24-119825	BE5-B982	639	24-139168	BE5-D916	224	24-143639	BE5-E363	301	24-152938	BE5-F293	703	24-171687	BE3-H168	727
24-119825	BE5-B982	640	24-139168	BE5-D916	348	24-143639	BE5-E363	760	24-155311	BE5-F531	365	24-171687	BE3-H168	756
24-120227	BE3-C022	406	24-139175	BE5-D917	224	24-143639	BE5-E363	763	24-155328	BE5-F532	365	24-171717	BE3-H171	166
24-120227	BE3-C022	421	24-139175	BE5-D917	348	24-143639	BE5-E363	764	24-155335	BE5-F533	365	24-171717	BE3-H171	180
24-120227	BE3-C022	451	24-139380	BE3-D938	453	24-143639	BE5-E363	773	24-156530	BE5-F653	279	24-171717	BE3-H171	191
24-120234	BE5-C023	406	24-139380	BE3-D938	455	24-143646	BE5-E364	278	24-158428	BE3-F842	351	24-171717	BE3-H171	321
24-120234	BE5-C023	420	24-139380	BE3-D938	456	24-143646	BE5-E364	284	24-158657	BE5-F865	433	24-171717	BE3-H171	322
24-120234	BE5-C023	451	24-139380	BE3-D938	457	24-143646	BE5-E364	291	24-158657	BE5-F865	436	24-171717	BE3-H171	509
24-120241	BE5-C024	406	24-139380	BE3-D938	458	24-143646	BE5-E364	303	24-158756	BE5-F875	803	24-171717	BE3-H171	510
24-120241	BE5-C024	421	24-139380	BE3-D938	459	24-143646	BE5-E364	760	24-158756	BE5-F875	805	24-171717	BE3-H171	554
24-120241	BE5-C024	451	24-139397	BE3-D939	453	24-143646	BE5-E364	764	24-158756	BE5-F875	876	24-171717	BE3-H171	726
24-120340	BE3-C034	384	24-139397	BE3-D939	455	24-143646	BE5-E364	773	24-158848	BE5-F884	304	24-171717	BE3-H171	727
24-120340	BE3-C034	386	24-139397	BE3-D939	456	24-143806	BE5-E380	163	24-158848	BE5-F884	307	24-171717	BE3-H171	756
24-120364	BE3-C036	384	24-139397	BE3-D939	457	24-143806	BE5-E380	171	24-158848	BE5-F884	308	24-172936	BE3-H293	19
24-120364	BE3-C036	386	24-139397	BE3-D939	458	24-143806	BE5-E380	188	24-158879	BE5-F887	12	24-172936	BE3-H293	20
24-120395	BE5-C039	123	24-139397	BE3-D939	459	24-143806	BE5-E380	190	24-158879	BE5-F887	519	24-172936	BE3-H293	23
24-120395	BE5-C039	126	24-140225	BE5-E022	240	24-143806	BE5-E380	314	24-158930	BE3-F893	304	24-172936	BE3-H293	26
24-120395	BE5-C039	128	24-140225	BE5-E022	241	24-143936	BE5-E393	154	24-158930	BE3-F893	307	24-172936	BE3-H293	632
24-120395	BE5-C039	130	24-140225	BE5-E022	242	24-143936	BE5-E393	155	24-158930	BE3-F893	308	24-172936	BE3-H293	633
24-120395	BE5-C039	161	24-140225	BE5-E022	519	24-143943	BE5-E394	154	24-164429	BE3-G442	436	24-172936	BE3-H293	634
24-120425	BE5-C042	14	24-140225	BE5-E022	520	24-143943	BE5-E394	155	24-164429	BE3-G442	451	24-172936	BE3-H293	648
24-120425	BE5-C042	15	24-140225	BE5-E022	736	24-143950	BE5-E395	154	24-165464	BE5-G546	570	24-172936	BE3-H293	654
24-120425	BE5-C042	124	24-140256	BE5-E025	11	24-143950	BE5-E395	155	24-165686	BE5-G568	570	24-172936	BE3-H293	663
24-120425	BE5-C042	126	24-140256	BE5-E025	240	24-143967	BE5-E396	154	24-165686	BE5-G568	571	24-172936	BE3-H293	665
24-120425	BE5-C042	128	24-140256	BE5-E025	241	24-143967	BE5-E396	155	24-166218	BE3-G621	398	24-172936	BE3-H293	672
24-120425	BE5-C042	130	24-140256	BE5-E025	242	24-143974	BE5-E397	154	24-166218	BE3-G621	400	24-172936	BE3-H293	673
24-120425	BE5-C042	161	24-140256	BE5-E025	519	24-143974	BE5-E397	155	24-166218	BE3-G621	401	24-172936	BE3-H293	674
24-120708	BE5-C070	146	24-140256	BE5-E025	520	24-143981	BE5-E398	154	24-166218	BE3-G621	450	24-172936	BE3-H293	796
24-121774	BE3-C177	420	24-140256	BE5-E025	736	24-143981	BE5-E398	155	24-166522	BE3-G652	398	24-172936	BE3-H293	799
24-121774	BE3-C177	451	24-140812	BE3-E081	199	24-143988	BE3-E399	118	24-166522	BE3-G652	400	24-172936	BE3-H293	806
24-121781	BE3-C178	406	24-140812	BE3-E081	577	24-143988	BE3-E399	120	24-166522	BE3-G652	401	24-172936	BE3-H293	810
24-121781	BE3-C178	420	24-140874	BE5-E087	478	24-144384	BE5-E438	478	24-166522	BE3-G652	450	24-172936	BE3-H293	815
24-121781	BE3-C178	422	24-140874	BE5-E087	479	24-144384	BE5-E438	479	24-166539	BE3-G653	399	24-172936	BE3-H293	816
24-121781	BE3-C178	451	24-140874	BE5-E087	488	24-144384	BE5-E438	488	24-166539	BE3-G653	400	24-172936	BE3-H293	835
24-121798	BE3-C179	420	24-140881	BE5-E088	479	24-144766	BE5-E476	193	24-166607	BE5-G660	434	24-172936	BE3-H293	836
24-121798	BE3-C179	451	24-141086	BE3-E108	320	24-144773	BE5-E477	193	24-166621	BE5-G662	434	24-172936	BE3-H293	837
24-121934	BE5-C193	434	24-141086	BE3-E108	517	24-144780	BE5-E478	193	24-166652	BE5-G665	433	24-172936	BE3-H293	838
24-122245	BE5-C224	310	24-141086	BE3-E108	540	24-144834	BE5-E483	433	24-166676	BE3-G667	398	24-172936	BE3-H293	839
24-122245	BE5-C224	311	24-141086	BE3-E108	734	24-144889	BE5-E488	434	24-166676	BE3-G667	400	24-172936	BE3-H293	840
24-122740	BE5-C274	574	24-141086	BE3-E108	735	24-144896	BE5-E489	434	24-166676	BE3-G667	450	24-172936	BE3-H293	852
24-122740	BE5-C274	575	24-141116	BE3-E111	321	24-144919	BE5-E491	433	24-166874	BE3-G687	423	24-172936	BE3-H293	854
24-122757	BE5-C275	574	24-141116	BE3-E111	517	24-145404	BE3-E540	436	24-166874	BE3-G687	451	24-172936	BE3-H293	856
24-122757	BE5-C275	575	24-141116	BE3-E111	517	24-145404	BE3-E540	437	24-166898	BE3-G689	423	24-172936	BE3-H293	870
24-122764	BE5-C276	574	24-141116	BE3-E111	540	24-145961	BE5-E596	52	24-166898	BE3-G689	451	24-172936	BE3-H293	873
24-122764	BE5-C276	575	24-141116	BE3-E111	735	24-145961	BE5-E596	54	24-166980	BE5-G698	433	24-172936	BE3-H293	875
24-122771	BE5-C277	574	24-141116	BE3-E111	736	24-145961	BE5-E596	56	24-166980	BE5-G698	436	24-172936	BE3-H293	877
24-122771	BE5-C277	575	24-141116	BE3-E111	745	24-145961	BE5-E596	57	24-166997	BE5-G699	436	24-172981	BE3-H298	436
24-122986		305	24-141352	BE5-E135	364	24-145961	BE5-E596	58	24-167659	BE5-G765	434	24-172981	BE3-H298	437
24-123266	BE3-C326	384	24-141369	BE5-E136	364	24-145961	BE5-E596	69	24-167666	BE5-G766	434	24-172981	BE3-H298	438
24-124362	BE5-C436	433	24-141680	BE3-E168	156	24-145961	BE5-E596	70	24-168014	BE5-G801	166	24-172981	BE3-H298	452
24-124379	BE5-C437	433	24-141680	BE3-E168	157	24-145961	BE5-E596	72	24-168014	BE5-G801	167	24-173032	BE5-H303	703
24-124508	BE5-C450	275	24-141727	BE5-E172	95	24-145961	BE5-E596	92	24-168014	BE5-G801	183	24-173049		



# New order number – Old order number

New	Old	Page	New	Old	Page	New	Old	Page	New	Old	Page	New	Old	Page
24-178006	BE3-H800	838	24-185387	BE5-6024	706	24-186735	BE5-D146	185	24-191197		343	24-203029	BE5-D243	344
24-178006	BE3-H800	839	24-185394	BE5-6025	706	24-186735	BE5-D146	186	24-191203		185	24-209755		430
24-178006	BE3-H800	840	24-185400	BE5-6092	305	24-186735	BE5-D146	189	24-191203		186	24-209779		430
24-178006	BE3-H800	852	24-185417	BE5-6093	305	24-186735	BE5-D146	313	24-191203		226	24-210294		484
24-178006	BE3-H800	856	24-185448	BE5-6206	304	24-186735	BE5-D146	314	24-191203		313	24-210294		489
24-178006	BE3-H800	871	24-185455	BE5-6207	304	24-186735	BE5-D146	336	24-191371		354	24-214001		332
24-178006	BE3-H800	873	24-185462	BE5-6208	304	24-186742	BE5-D147	185	24-192941		187	24-214018		365
24-178006	BE3-H800	875	24-185479	BE5-6209	304	24-186742	BE5-D147	186	24-193221		475	24-214018		703
24-178006	BE3-H800	877	24-185493	BE5-6215	303	24-186742	BE5-D147	313	24-193238		475	24-214070		406
24-178488	BE5-H848	146	24-185493	BE5-6215	311	24-186766	BE5-D186	487	24-193245		475	24-214230		865
24-178488	BE5-H848	147	24-185509	BE5-6216	303	24-186773	BE5-D187	487	24-193276		759	24-215220		372
24-178488	BE5-H848	148	24-185509	BE5-6216	311	24-186797	BE5-D721	348	24-193276		763	24-215220		373
24-178488	BE5-H848	149	24-185523	BE5-6243	304	24-186797	BE5-D721	349	24-193276		764	24-215220		382
24-178488	BE5-H848	162	24-185523	BE5-6243	305	24-186803	BE5-D722	348	24-193382		367	24-215237		372
24-178495	BE5-H849	146	24-185523	BE5-6243	306	24-186803	BE5-D722	349	24-193382		683	24-215237		373
24-178495	BE5-H849	147	24-185523	BE5-6243	307	24-186810	BE5-D784	350	24-193399		367	24-215237		382
24-178495	BE5-H849	148	24-185523	BE5-6243	308	24-186827	BE5-D785	350	24-193399		683	24-215662		434
24-178495	BE5-H849	149	24-185530	BE5-6244	304	24-186834	BE5-D972	189	24-193580		146	24-216579		434
24-178495	BE5-H849	162	24-185530	BE5-6244	305	24-186841	BE5-E011	185	24-193597		146	24-216951		193
24-178501	BE5-H850	146	24-185530	BE5-6244	306	24-186872	BE5-E174	351	24-193672	BE5-H325	339	24-216951		223
24-178501	BE5-H850	147	24-185615	BE5-6254	336	24-186926	BE5-E374	171	24-193702		339	24-216951		224
24-178501	BE5-H850	149	24-185622	BE5-6255	347	24-186926	BE5-E374	189	24-194112		406	24-217552		430
24-178501	BE5-H850	163	24-185622	BE5-6255	348	24-186926	BE5-E374	190	24-194112		423	24-217675		250
24-178518	BE5-H851	146	24-185622	BE5-6255	349	24-186933	BE5-E375	190	24-194112		451	24-217675		251
24-178518	BE5-H851	147	24-185639	BE5-6256	347	24-186940	BE5-E376	171	24-194129		406	24-217675		279
24-178518	BE5-H851	149	24-185653	BE5-6457	349	24-186940	BE5-E376	185	24-194129		423	24-217859		100
24-178518	BE5-H851	163	24-185660	BE5-6458	349	24-186940	BE5-E376	189	24-194129		451	24-217859		101
24-178525	BE5-H852	146	24-185677	BE5-6501	170	24-186940	BE5-E376	190	24-194136		407	24-217859		102
24-178617	BE5-H861	146	24-185677	BE5-6501	185	24-186957	BE5-E377	185	24-194136		424	24-217859		131
24-178617	BE5-H861	147	24-185677	BE5-6501	188	24-186964	BE5-E428	706	24-195065		10	24-217859		133
24-181464	B36-0370	94	24-185677	BE5-6501	314	24-186971	BE5-E429	706	24-195065		224	24-217859		134
24-181464	B36-0370	342	24-185745	BE5-6582	708	24-186988	BE5-E523	225	24-195065		257	24-217859		161
24-181464	B36-0370	452	24-185752	BE5-6583	708	24-186995	BE5-E578	351	24-195096		10	24-217873		101
24-181464	B36-0370	626	24-185776	BE5-6681	226	24-187053	BE5-E653	478	24-195096		224	24-217873		102
24-181471	B36-0380	94	24-185776	BE5-6681	307	24-187053	BE5-E653	479	24-195096		257	24-217873		131
24-181471	B36-0380	342	24-185776	BE5-6681	309	24-187053	BE5-E653	488	24-195294		589	24-217873		133
24-181471	B36-0380	452	24-185783	BE5-6682	170	24-187077	BE5-E655	187	24-195294		590	24-217873		134
24-181471	B36-0380	626	24-185783	BE5-6682	188	24-187077	BE5-E655	314	24-195409		457	24-217873		161
24-181488	B46-0040	817	24-185783	BE5-6682	189	24-187084	BE5-E656	187	24-195409		459	24-218245		432
24-181488	B46-0040	863	24-185783	BE5-6682	190	24-187084	BE5-E656	314	24-195416		457	24-218269		432
24-181495	B46-0137	77	24-185783	BE5-6682	225	24-187091	BE5-E672	336	24-195416		459	24-218283		432
24-181495	B46-0137	782	24-185783	BE5-6682	226	24-187121	BE5-E686	488	24-195690		773	24-218474		595
24-181495	B46-0137	840	24-185783	BE5-6682	314	24-187152	BE5-E689	478	24-195706		773	24-218474		596
24-181495	B46-0137	841	24-185813	BE5-6738	705	24-187152	BE5-E689	479	24-196277		311	24-218641		864
24-181495	B46-0137	842	24-185912	BE5-A937	336	24-187169	BE5-E690	488	24-196284		307	24-218689		864
24-181501	B46-0387	630	24-185929	BE5-A938	350	24-187183	BE5-E710	185	24-196284		309	24-219952		595
24-181846	BE5-63207	629	24-185943	BE5-A940	347	24-187183	BE5-E710	186	24-196390		339	24-219952		596
24-181853	BE5-63310	77	24-185943	BE5-A940	348	24-187183	BE5-E710	313	24-196499		701	24-220118		385
24-184564	B36-2176	224	24-185943	BE5-A940	350	24-187190	BE5-F100	350	24-196529		274	24-220118		386
24-184601	B46-0425	708	24-185950	BE5-B513	170	24-187206	BE5-F138	336	24-196529		276	24-220118		402
24-184618	B46-0617	104	24-185950	BE5-B513	185	24-187213	BE5-F255	226	24-196529		302	24-221726	BE5-2398	249
24-184632	B46-0925	225	24-185950	BE5-B513	188	24-187237	BE5-F265	171	24-196529		374	24-221726	BE5-2398	311
24-184656	B46-1105	304	24-185950	BE5-B513	190	24-187237	BE5-F265	171	24-196529		383	24-221948		180
24-184663	B46-1106	304	24-185950	BE5-B513	313	24-187237	BE5-F265	188	24-196529		756	24-221948		181
24-184724	B46-1495	303	24-185967	BE5-B625	487	24-187237	BE5-F265	189	24-196529		758	24-222099		651
24-184724	B46-1495	366	24-185974	BE5-C265	310	24-187237	BE5-F265	190	24-196529		772	24-222099		655
24-184724	B46-1495	452	24-185981	BE5-C296	306	24-187244	BE5-F332	708	24-196550		274	24-222099		856
24-184731	B46-1497	303	24-185981	BE5-C296	307	24-187251	BE5-F348	705	24-196550		276	24-222112		651
24-184731	B46-1497	366	24-185981	BE5-C296	308	24-187251	BE5-F348	705	24-196550		302	24-222112		655
24-184755	B46-1498	303	24-185981	BE5-C296	309	24-187381	BE5-G549	306	24-196550		374	24-222112		856
24-184755	B46-1498	366	24-186018	BE5-C335	307	24-187404	BE5-G551	305	24-196550		383	24-222143		367
24-184762	B46-1568	304	24-186018	BE5-C335	309	24-187428	BE5-G594	171	24-196550		756	24-222143		490
24-184809	B46-1616	304	24-186025	BE5-C336	307	24-187428	BE5-G594	172	24-196550		758	24-222143		491
24-184809	B46-1616	305	24-186025	BE5-C336	308	24-187428	BE5-G594	173	24-196550		759	24-222143		685
24-184847	B46-1907	225	24-186025	BE5-C336	309	24-187428	BE5-G594	313	24-196550		772	24-222143		686
24-184854	B46-1908	225	24-186056	BE5-C515	706	24-187435	BE5-G611	181	24-196901		424	24-222143		687
24-184885	B46-2067	478	24-186063	BE5-C603	226	24-187466	BE5-G738	306	24-196901		425	24-222143		710
24-184915	B46-2129	225	24-186070	BE5-C604	226	24-187497	BE5-G741	306	24-196918		436	24-222181		773
24-184922	B46-2130	225	24-186087	BE5-C605	226	24-187541	BE5-H150	701	24-196918		451	24-222181		774
24-184984	B46-2335	311	24-186094	BE5-C614	226	24-187558	BE5-H151	701	24-196925		430	24-222198		773
24-185004	BE3-6420	478	24-186155	BE5-D744	478	24-187824		478	24-197083		599	24-222198		774
24-185011	BE3-6422	478	24-186162	BE5-D934	177	24-187824		480	24-197083		855	24-222426	BE5-2608	452
24-185011	BE3-6422	488	24-186179	BE5-D935	177	24-187824		488	24-197205		154	24-222976		175
24-185080	BE5-2400	479	24-186193	BE5-D973	177	24-187831		171	24-197236		406	24-223416		385
24-185097	BE5-2401	479	24-186209	BE5-D974	177	24-187831		172	24-197243		406	24-223416		386
24-185134	BE5-2489	305	24-186216	BE5-E075	348	24-187831		173	24-197243		407	24-223416		402
24-185141	BE5-2490	305	24-186223	BE5-E076	348	24-187831		313	24-197427		479	24-223447		385
24-185158	BE5-2504	225	24-186230	BE5-E235	706									



# New order number – Old order number

New	Old	Page	New	Old	Page	New	Old	Page	New	Old	Page	New	Old	Page
24-224024	BE5-2738	859	24-236997	B46-0653	812	25-187601	BR5-G695	171	26-224572		123	31-633499	VM3-63349	157
24-225076		564	24-236997	B46-0653	851	25-187601	BR5-G695	189	26-224572		128	31-633505	VM3-63350	14
24-225397		175	24-236997	B46-0653	852	25-187601	BR5-G695	190	26-224572		130	31-633505	VM3-63350	15
24-225397		585	24-237338		614	25-187601	BR5-G695	226	26-231303		144	31-633505	VM3-63350	97
24-225410		349	24-238588		604	25-187618	BR5-G713	171	26-234229		148	31-633505	VM3-63350	98
24-225427		349	24-239110		490	25-187618	BR5-G713	185	26-237138		431	31-633505	VM3-63350	99
24-225434		349	24-239134		490	25-187618	BR5-G713	186	26-237145		431	31-633505	VM3-63350	116
24-225441		349	24-239943		599	25-187618	BR5-G713	189	26-602059	BM5-60205	110	31-633505	VM3-63350	119
24-225793		348	24-239943		855	25-187618	BR5-G713	314	26-602059	BM5-60205	112	31-633505	VM3-63350	120
24-225793		349	24-239950		599	25-187618	BR5-G713	315	26-602059	BM5-60205	116	31-633505	VM3-63350	122
24-226776		765	24-239950		855	25-187618	BR5-G713	336	26-602059	BM5-60205	119	31-633505	VM3-63350	125
24-227544		476	24-242110		564	25-187625	BR5-G714	171	26-602059	BM5-60205	120	31-633505	VM3-63350	127
24-228398		678	24-242127		564	25-187625	BR5-G714	185	26-602059	BM5-60205	122	31-633505	VM3-63350	129
24-228398		701	24-242127		565	25-187625	BR5-G714	186	26-602059	BM5-60205	156	31-633505	VM3-63350	131
24-228435		678	24-242707		379	25-187625	BR5-G714	189	26-602059	BM5-60205	157	31-633505	VM3-63350	156
24-228435		701	24-243742		379	25-187625	BR5-G714	190	26-624648	BM5-62464	591	31-633505	VM3-63350	157
24-228992		433	24-577410	B36-57741	249	25-187625	BR5-G714	314	26-630113	VM3-63011	591	32-145519	VR3-E551	591
24-229005		386	24-577700	B46-57770	249	25-187625	BR5-G714	315	26-633510	BM5-63351	14	32-145526	BR5-E552	593
24-229258		310	24-591522	B46-59152	511	25-187625	BR5-G714	336	26-633510	BM5-63351	15	32-616965	BR5-61696	591
24-229753	BE3-63949	15	24-591522	B46-59152	536	25-187632	BR5-G717	351	26-633510	BM5-63351	97	33-023519	BE5-2351	703
24-229760	BE3-63950	15	24-595452	BE5-59545	587	25-187649	BR5-G718	351	26-633510	BM5-63351	98	33-028187		306
24-229883		26	24-599955	BE5-59995	585	25-187656	BR5-G719	351	26-633510	BM5-63351	99	33-028187		308
24-229883		28	24-599962	BE5-59996	585	25-187663	BR5-G720	351	26-633510	BM5-63351	125	33-061399		173
24-229883		649	24-604277	BE5-60427	158	25-187670	BR5-G721	348	26-633510	BM5-63351	127	33-061399		177
24-229883		667	24-607896	BE3-60789	635	25-187687	BR5-G918	185	26-633510	BM5-63351	129	33-061399		314
24-229883		668	24-607896	BE3-60789	818	25-187687	BR5-G918	186	26-633510	BM5-63351	131	33-061399		315
24-229883		807	24-618106	BE3-61810	877	25-187687	BR5-G918	314	27-105993	BF3-A599	422	33-066868		347
24-229883		809	24-618113	BE3-61811	877	25-187694	BR5-G919	185	27-124260	BR5-C426	591	33-066868		348
24-229890		26	24-627009	BE5-62700	786	25-187694	BR5-G919	186	27-219935	BA5-F650	433	33-067230	BE5-6723	765
24-229890		27	24-627009	BE5-62700	788	25-187694	BR5-G919	314	28-188629	RE3-H772	586	33-067230	BE5-6723	766
24-229890		28	24-627009	BE5-62700	813	25-187779	BR5-H075	307	28-188629	RE3-H772	587	33-124254	VR3-C425	593
24-229890		649	24-627726	BE5-62772	491	25-187779	BR5-H075	309	28-188629	RE3-H772	588	33-151618	BE5-F161	348
24-229890		667	24-627726	BE5-62772	531	25-187786	BR5-H076	307	28-214212	P30-57939	705	33-151632	BE5-F163	349
24-229890		668	24-629485	BE3-62948	785	25-187786	BR5-H076	309	28-240921	XDE-05767	589	33-151649	BE5-F164	349
24-229890		807	24-629485	BE3-62948	787	25-187793	BR5-H312	350	29-196500		276	33-151656	BE5-F165	304
24-229890		807	24-629485	BE3-62948	813	25-187793	BR5-H312	351	29-196500		277	33-151663	BE5-F166	347
24-229890		808	24-630016	BE5-63001	152	25-187809	BR5-H313	350	29-196517		276	33-151663	BE5-F166	348
24-229890		809	24-630085	BE3-63008	489	25-187809	BR5-H313	351	29-196517		277	33-151670	BE5-F167	348
24-229920		27	24-630085	BE3-63008	490	25-187816	BR5-H410	348	29-196531		276	33-158723	BE5-F872	803
24-229920		28	24-631129	BE5-63112	511	25-188363		307	29-196531		277	33-158723	BE5-F872	805
24-229920		649	24-631129	BE5-63112	536	25-188363		308	29-196548		276	33-158723	BE5-F872	876
24-229920		667	24-631136	BE3-63113	511	25-188363		309	29-196548		277	33-170862	BE5-H086	307
24-229920		668	24-631136	BE3-63113	536	25-188370		307	31-181884	VM3-H362	115	33-170862	BE5-H086	309
24-229920		808	24-632133	BE5-63213	158	25-188370		308	31-181884	VM3-H362	118	33-174525	BE5-H452	170
24-229920		809	24-632140	BE5-63214	158	25-188370		309	31-181884	VM3-H362	120	33-174525	BE5-H452	185
24-229937		27	24-632157	BE5-63215	84	25-188387		307	31-181884	VM3-H362	121	33-174525	BE5-H452	186
24-229937		28	24-632164	BE5-63216	84	25-188387		308	31-181884	VM3-H362	160	33-174525	BE5-H452	189
24-229937		649	24-632171	BE3-63217	521	25-188394		307	31-181891	VM3-H363	115	33-174525	BE5-H452	313
24-229937		650	24-632171	BE3-63217	523	25-188394		308	31-181891	VM3-H363	118	33-174525	BE5-H452	314
24-229937		667	24-632188	BE3-63218	859	25-193114		350	31-181891	VM3-H363	120	33-174525	BE5-H452	336
24-229937		668	24-632539	BE5-63253	84	25-193121		350	31-181891	VM3-H363	121	33-185347	BE5-2819	308
24-229937		669	24-632560	BE5-63256	84	25-193138		350	31-181891	VM3-H363	160	33-185514	BE5-6242	350
24-229937		808	24-632614	BE5-63261	84	25-193145		350	31-181914	VM3-H616	14	33-185545	BE5-6245	304
24-229937		809	24-632621	BE5-63262	84	25-194012		350	31-181914	VM3-H616	15	33-185545	BE5-6245	307
24-230964		385	24-632683	BE3-63268	490	25-197754		226	31-181914	VM3-H616	96	33-185545	BE5-6245	308
24-230964		402	24-632683	BE3-63268	520	25-197761		226	31-181914	VM3-H616	98	33-185552	BE5-6248	187
24-231190		509	24-632690	BE5-63269	490	25-227611		701	31-181914	VM3-H616	99	33-185552	BE5-6248	314
24-231190		727	24-632690	BE5-63269	520	26-118260	BA5-B826	592	31-181914	VM3-H616	100	33-185569	BE5-6249	187
24-231282		476	24-632799	BE5-63279	863	26-118260	BA5-B826	594	31-181914	VM3-H616	123	33-185569	BE5-6249	314
24-231312		655	24-632805	BE5-63280	863	26-118260	BA5-B826	595	31-181914	VM3-H616	126	33-185590	BE5-6252	187
24-231312		669	24-633116	BE5-63311	77	26-118284	BA5-B828	592	31-181914	VM3-H616	128	33-185590	BE5-6252	314
24-231428		655	24-633369	BE5-63336	176	26-118284	BA5-B828	594	31-181914	VM3-H616	130	33-185606	BE5-6253	303
24-231428		669	24-633369	BE5-63336	322	26-118284	BA5-B828	595	31-181914	VM3-H616	161	33-185859	BE5-A702	224
24-231657		578	24-633369	BE5-63336	323	26-147543	VA7-E754	592	31-181921	VM3-H617	14	33-185897	BE5-A935	305
24-231725	BL5-C227	357	24-633369	BE5-63336	342	26-147543	VA7-E754	593	31-181921	VM3-H617	15	33-185934	BE5-A939	350
24-231732	BL5-C140	357	24-633369	BE5-63336	524	26-147543	VA7-E754	594	31-181921	VM3-H617	96	33-186009	BE5-C299	305
24-231749	BL5-C327	357	24-633369	BE5-63336	731	26-181905	BM5-H364	115	31-181921	VM3-H617	98	33-186542	BE5-A463	187
24-231756	BL5-C330	357	24-633376	BE5-63337	176	26-181905	BM5-H364	118	31-181921	VM3-H617	99	33-186542	BE5-A463	303
24-231763	BL5-C331	357	24-633376	BE5-63337	322	26-181905	BM5-H364	120	31-181921	VM3-H617	100	33-186542	BE5-A463	314
24-231770	BL5-C329	357	24-633376	BE5-63337	323	26-181905	BM5-H364	121	31-181921	VM3-H617	123	33-186542	BE5-A463	347
24-231787	BL5-C225	357	24-633376	BE5-63337	342	26-181905	BM5-H364	160	31-181921	VM3-H617	126	33-186887	BE5-E175	351
24-231794	BL5-C149	357	24-633376	BE5-63337	524	26-181936	BM5-H618	14	31-181921	VM3-H617	128	33-187174	BE5-E703	701
24-231800	BL5-C328	357	24-633376	BE5-63337	731	26-181936	BM5-H618	15	31-181921	VM3-H617	130	33-187228	BE5-F256	226
24-231985		149	24-634038	BE3-63403	223	26-181936	BM5-H618	96	31-181921	VM3-H617	161	33-187228	BE5-F256	336
24-232074		385	24-634045	BE3-63404	223	26-181936	BM5-H618	98	31-224550		123	33-187266	BE5-F349	705
24-232074		402	24-848879	BE5-04887	589									



# New order number – Old order number

New	Old	Page	New	Old	Page	New	Old	Page	New	Old	Page	New	Old	Page
34-000243	P36-0024	158	34-002513	P36-0251	106	34-030066	P30-3006	84	34-050538	RE2-5053	340	35-004004	V36-0400	623
34-000243	P36-0024	159	34-002629	P36-0262	472	34-030097	P30-3009	696	34-050545	RE2-5054	340	35-005452	V36-0545	558
34-000243	P36-0024	160	34-002636	P30-0263	475	34-030103	P36-3010	475	34-100608	PE3-A060	150	35-005452	V36-0545	571
34-000250	P30-0025	158	34-002645	P30-0264	472	34-030103	P36-3010	476	34-101803	PE3-A180	355	35-005469	V36-0546	558
34-000311	P36-0031	859	34-002926	P36-0292	767	34-030110	P30-3011	342	34-110096	PE3-B009	14	35-005469	V36-0546	571
34-000403	P30-0040	596	34-002926	P36-0292	768	34-030110	P30-3011	481	34-110096	PE3-B009	152	35-005476	V36-0547	558
34-000403	P30-0040	597	34-002926	P36-0292	769	34-030165	P36-3016	78	34-181515	P30-0034	817	35-005476	V36-0547	571
34-000403	P30-0040	817	34-002926	P36-0292	770	34-030165	P36-3016	79	34-181522	P30-0128	105	35-005483	V36-0548	558
34-000427	P30-0042	95	34-002926	P36-0292	771	34-030165	P36-3016	83	34-181522	P30-0128	106	35-005483	V36-0548	571
34-000427	P30-0042	357	34-002926	P36-0292	772	34-030172	P36-3017	78	34-181539	P36-0081	765	35-005520	V36-0552	572
34-000533	P30-0053	232	34-003114	P36-0311	181	34-030172	P36-3017	79	34-181539	P36-0081	766	35-040163	V36-4016	620
34-000533	P30-0053	249	34-003114	P36-0311	220	34-030172	P36-3017	80	34-181546	P36-0243	136	35-040163	V36-4016	621
34-000533	P30-0053	878	34-003114	P36-0311	315	34-030172	P36-3017	83	34-181546	P36-0243	137	35-040163	V36-4016	622
34-000540	P30-0054	232	34-003114	P36-0311	524	34-030172	P36-3017	84	34-181553	P36-0258	150	35-040163	V36-4016	623
34-000540	P30-0054	249	34-003114	P36-0311	525	34-030189	P36-3018	138	34-181560	P36-0361	150	35-040194	V36-4019	704
34-000540	P30-0054	878	34-003114	P36-0311	527	34-030189	P36-3018	139	34-181577	P36-0365	315	35-040200	V36-4020	704
34-000588	P30-0058	249	34-003114	P36-0311	528	34-030189	P36-3018	150	34-181577	P36-0365	316	35-040286	V36-4028	260
34-000670	P36-0067	460	34-003114	P36-0311	529	34-030196	P36-3019	138	34-181577	P36-0365	493	35-040286	V36-4028	261
34-000885	P30-0088	460	34-003114	P36-0311	530	34-030196	P36-3019	139	34-181577	P36-0365	494	35-040286	V36-4028	262
34-000885	P30-0088	462	34-003114	P36-0311	710	34-030196	P36-3019	140	34-181577	P36-0365	495	35-040286	V36-4028	263
34-000885	P30-0088	463	34-003114	P36-0311	711	34-030202	P36-3020	138	34-181577	P36-0365	496	35-040286	V36-4028	286
34-000939	P36-0093	358	34-003114	P36-0311	712	34-030202	P36-3020	139	34-181577	P36-0365	497	35-040408	V36-4040	288
34-000984	P30-0098	694	34-003114	P36-0311	713	34-030202	P36-3020	140	34-181577	P36-0365	715	35-040408	V36-4040	289
34-001011	P30-0101	257	34-003114	P36-0311	714	34-030219	P36-3021	138	34-181577	P36-0365	716	35-040408	V36-4040	290
34-001028	P30-0102	785	34-003268	P36-0326	135	34-030226	P36-3022	138	34-181577	P36-0365	717	35-040415	V36-4041	288
34-001028	P30-0102	813	34-003268	P36-0326	136	34-030226	P36-3022	140	34-181584	P36-0366	321	35-040415	V36-4041	289
34-001028	P30-0102	874	34-003268	P36-0326	159	34-030233	P36-3023	138	34-181584	P36-0366	510	35-040415	V36-4041	290
34-001042	P30-0104	596	34-003268	P36-0326	160	34-030233	P36-3023	140	34-181584	P36-0366	728	35-040460	V36-4046	601
34-001042	P30-0104	597	34-003343	P30-0334	105	34-030585	P36-3058	80	34-184530		784	35-040460	V36-4046	602
34-001103	P36-0110	257	34-003343	P30-0334	106	34-030585	P36-3058	81	34-184530		851	35-040477	V36-4047	602
34-001127	P36-0112	586	34-003350	P36-0335	13	34-030585	P36-3058	84	34-184530		852	35-040590	V36-4059	165
34-001127	P36-0112	587	34-003350	P36-0335	105	34-030592	P30-3059	194	34-186350	P30-0125	104	35-040590	V36-4059	167
34-001127	P36-0112	596	34-003350	P36-0335	106	34-030592	P30-3059	208	34-236406	PE3-64077	13	35-040590	V36-4059	178
34-001134	P36-0113	586	34-003350	P36-0335	107	34-030592	P30-3059	556	34-236406	PE3-64077	105	35-040590	V36-4059	320
34-001134	P36-0113	587	34-003497	P36-0349	704	34-030592	P30-3059	557	34-236437	PE3-3082	495	35-040590	V36-4059	513
34-001141	P36-0114	586	34-003510	P30-0351	194	34-030608	P30-3060	194	34-236437	PE3-3082	525	35-040590	V36-4059	514
34-001158	P36-0115	586	34-003510	P30-0351	208	34-030608	P30-3060	208	34-236437	PE3-3082	527	35-040590	V36-4059	515
34-001158	P36-0115	587	34-003510	P30-0351	556	34-030608	P30-3060	556	34-237229	P30-0041	95	35-040590	V36-4059	516
34-001158	P36-0115	588	34-003510	P30-0351	557	34-030608	P30-3060	557	34-237229	P30-0041	357	35-040590	V36-4059	540
34-001165	P36-0116	586	34-003527	P30-0352	693	34-030615	P30-3061	705	34-237236	P30-0043	357	35-040590	V36-4059	733
34-001165	P36-0116	587	34-003534	P36-0353	150	34-030622	P30-3062	705	34-237243	P30-0044	357	35-040590	V36-4059	734
34-001165	P36-0116	588	34-003671	P36-0367	542	34-030677	P36-3067	767	34-237250	P30-0154	95	35-040590	V36-4059	740
34-001219	P30-0121	104	34-003671	P36-0367	543	34-030677	P36-3067	768	34-237250	P30-0154	357	35-040590	V36-4059	741
34-001363	P36-0136	105	34-003671	P36-0367	730	34-030677	P36-3067	769	34-465578	P30-46557	877	35-040590	V36-4059	742
34-001363	P36-0136	106	34-003671	P36-0367	731	34-030684	P36-3068	357	34-465585	P30-46558	877	35-040590	V36-4059	745
34-001363	P36-0136	155	34-003688	P36-0368	150	34-030721	P36-3072	182	34-594520	P30-59452	158	35-040606	V32-4060	617
34-001370	P30-0137	778	34-003695	P36-0369	59	34-030721	P36-3072	218	34-610848	VE3-61084	591	35-041313	V36-4131	565
34-001370	P30-0137	784	34-003695	P36-0369	60	34-030721	P36-3072	219	34-612200	RE3-61220	586	35-041313	V36-4131	566
34-001370	P30-0137	812	34-003695	P36-0369	61	34-030721	P36-3072	220	34-612200	RE3-61220	587	35-041313	V36-4131	567
34-001370	P30-0137	851	34-003695	P36-0369	71	34-030721	P36-3072	315	34-612200	RE3-61220	588	35-041320	V36-4132	565
34-001370	P30-0137	852	34-003695	P36-0369	87	34-030721	P36-3072	524	34-632192	PE3-63219	158	35-041320	V36-4132	566
34-001417	P36-0141	511	34-003695	P36-0369	88	34-030721	P36-3072	527	35-000396	V36-0039	258	35-041320	V36-4132	567
34-001417	P36-0141	537	34-003695	P36-0369	89	34-030721	P36-3072	528	35-000396	V36-0039	259	35-041337	V36-4133	566
34-001417	P36-0141	728	34-003695	P36-0369	90	34-030721	P36-3072	530	35-000945	V36-0094	342	35-041337	V36-4133	567
34-001417	P36-0141	743	34-003695	P36-0369	91	34-030721	P36-3072	710	35-000945	V36-0094	533	35-041344	V36-4134	566
34-001417	P36-0141	754	34-003701	P36-0370	59	34-030721	P36-3072	711	35-000945	V36-0094	537	35-041344	V36-4134	567
34-001424	P36-0142	181	34-003701	P36-0370	60	34-030721	P36-3072	712	35-000945	V36-0094	728	35-041382	V36-4138	309
34-001424	P36-0142	218	34-003701	P36-0370	70	34-030806	P36-3080	765	35-000945	V36-0094	729	35-041382	V36-4138	310
34-001424	P36-0142	219	34-003701	P36-0370	85	34-030806	P36-3080	766	35-000945	V36-0094	743	35-041696	VE3-4169	151
34-001424	P36-0142	220	34-003701	P36-0370	87	34-030837	PE3-3083	765	35-001065	V36-0106	786	35-041702	VE3-4170	151
34-001424	P36-0142	221	34-003701	P36-0370	88	34-030837	PE3-3083	766	35-001270	V36-0127	586	35-041757	VE3-4175	178
34-001424	P36-0142	315	34-003701	P36-0370	89	34-030868	PE3-3086	80	35-001270	V36-0127	587	35-041757	VE3-4175	179
34-001424	P36-0142	524	34-003701	P36-0370	90	34-030868	PE3-3086	82	35-001287	V36-0128	586	35-041757	VE3-4175	320
34-001424	P36-0142	525	34-003701	P36-0370	91	34-030868	PE3-3086	83	35-001287	V36-0128	587	35-041757	VE3-4175	513
34-001424	P36-0142	526	34-003725	P36-0372	321	34-030936	PE3-3093	630	35-002147	V36-0214	781	35-041757	VE3-4175	514
34-001424	P36-0142	528	34-003725	P36-0372	510	34-030936	PE3-3093	631	35-003663	V36-0366	785	35-041757	VE3-4175	516
34-001424	P36-0142	529	34-003725	P36-0372	728	34-031049	PE3-3104	626	35-003663	V36-0366	787	35-041757	VE3-4175	540
34-001424	P36-0142	530	34-030011	P30-3001	77	34-031056	PE3-3105	626	35-003663	V36-0366	813	35-041757	VE3-4175	733
34-001424	P36-0142	710	34-030011	P30-3001	82	34-031483	PE3-3148	150	35-003663	V36-0366	874	35-041757	VE3-4175	741
34-001424	P36-0142	711	34-030011	P30-3001	841	34-031520	PE3-3152	765	35-003717	V36-0371	342	35-041757	VE3-4175	742
34-001424	P36-0142	712	34-030011	P3										



# New order number – Old order number

New	Old	Page	New	Old	Page	New	Old	Page	New	Old	Page	New	Old	Page
35-043911	VE3-4391	781	35-044260	VE3-4426	534	35-050179	VE3-5017	561	35-102533	VE3-A253	168	35-108191	VE3-A819	873
35-043911	VE3-4391	785	35-044260	VE3-4426	535	35-050179	VE3-5017	562	35-102533	VE3-A253	627	35-108191	VE3-A819	877
35-043911	VE3-4391	787	35-044260	VE3-4426	742	35-051145	VE3-5114	602	35-102540	VE3-A254	168	35-109631	VE3-A963	144
35-043911	VE3-4391	789	35-044338	VE3-4433	743	35-051145	VE3-5114	603	35-102540	VE3-A254	627	35-109631	VE3-A963	146
35-043911	VE3-4391	790	35-044338	VE3-4433	169	35-051152	VE3-5115	602	35-103233	VE3-A323	453	35-109631	VE3-A963	162
35-043911	VE3-4391	795	35-044338	VE3-4433	316	35-051169	VE3-5116	602	35-103233	VE3-A323	454	35-109655	VE3-A965	144
35-043911	VE3-4391	813	35-044338	VE3-4433	317	35-051169	VE3-5116	603	35-103240	VE3-A324	453	35-109655	VE3-A965	146
35-043911	VE3-4391	845	35-044338	VE3-4433	319	35-051176	VE3-5117	603	35-103240	VE3-A324	454	35-109655	VE3-A965	148
35-043911	VE3-4391	858	35-044338	VE3-4433	498	35-051398	VE3-5139	270	35-103509	VE3-A350	277	35-109655	VE3-A965	162
35-043928	VE3-4392	637	35-044338	VE3-4433	499	35-051398	VE3-5139	271	35-103509	VE3-A350	632	35-110552	VE3-B055	599
35-043928	VE3-4392	638	35-044338	VE3-4433	501	35-051398	VE3-5139	272	35-103509	VE3-A350	853	35-110552	VE3-B055	855
35-043928	VE3-4392	639	35-044338	VE3-4433	502	35-051404	VE3-5140	270	35-103516	VE3-A351	277	35-110569	VE3-B056	599
35-043928	VE3-4392	641	35-044338	VE3-4433	503	35-051404	VE3-5140	271	35-103516	VE3-A351	632	35-110569	VE3-B056	855
35-043928	VE3-4392	642	35-044338	VE3-4433	718	35-051404	VE3-5140	272	35-103516	VE3-A351	853	35-110583	VE3-B058	599
35-043928	VE3-4392	781	35-044338	VE3-4433	719	35-051411	VE3-5141	270	35-103547	VE3-A354	268	35-110583	VE3-B058	855
35-043928	VE3-4392	787	35-044338	VE3-4433	721	35-051411	VE3-5141	271	35-103547	VE3-A354	368	35-110590	VE3-B059	599
35-043928	VE3-4392	789	35-044338	VE3-4433	722	35-051411	VE3-5141	272	35-103554	VE3-A355	268	35-110590	VE3-B059	855
35-043928	VE3-4392	790	35-044345	VE3-4434	169	35-051428	VE3-5142	270	35-103554	VE3-A355	368	35-110651	VE3-B065	231
35-043928	VE3-4392	795	35-044345	VE3-4434	316	35-051428	VE3-5142	271	35-103578	VE3-A357	268	35-110651	VE3-B065	539
35-043928	VE3-4392	858	35-044345	VE3-4434	317	35-051428	VE3-5142	272	35-103578	VE3-A357	368	35-110651	VE3-B065	548
35-043935	VE3-4393	155	35-044345	VE3-4434	319	35-051480	VE3-5148	282	35-103585	VE3-A358	268	35-110651	VE3-B065	549
35-043935	VE3-4393	156	35-044345	VE3-4434	498	35-051480	VE3-5148	283	35-103585	VE3-A358	368	35-110651	VE3-B065	552
35-043942	VE3-4394	155	35-044345	VE3-4434	500	35-051480	VE3-5148	302	35-104384	VE3-A438	277	35-110651	VE3-B065	744
35-043942	VE3-4394	156	35-044345	VE3-4434	501	35-051497	VE3-5149	346	35-104391	VE3-A439	277	35-110651	VE3-B065	750
35-043959	VE3-4395	636	35-044345	VE3-4434	502	35-051503	VE3-5150	346	35-105855	VE3-A585	108	35-110651	VE3-B065	751
35-043959	VE3-4395	641	35-044345	VE3-4434	718	35-051688	VE3-5168	628	35-105855	VE3-A585	111	35-110651	VE3-B065	753
35-043959	VE3-4395	652	35-044345	VE3-4434	720	35-051695	VE3-5169	628	35-105855	VE3-A585	113	35-110668	VE3-B066	231
35-043959	VE3-4395	787	35-044345	VE3-4434	721	35-051695	VE3-5169	629	35-105862	VE3-A586	108	35-110668	VE3-B066	539
35-043959	VE3-4395	789	35-044345	VE3-4434	722	35-052173	VE3-5217	16	35-105862	VE3-A586	111	35-110668	VE3-B066	548
35-043959	VE3-4395	858	35-044668	VE3-04466	289	35-052173	VE3-5217	639	35-105862	VE3-A586	113	35-110668	VE3-B066	549
35-043966	VE3-4396	636	35-045939	VE3-4593	310	35-052173	VE3-5217	643	35-107354	VE3-A735	338	35-110668	VE3-B066	552
35-043966	VE3-4396	641	35-045984	VE3-4598	191	35-052173	VE3-5217	656	35-107354	VE3-A735	341	35-110668	VE3-B066	744
35-043966	VE3-4396	652	35-045984	VE3-4598	323	35-052173	VE3-5217	657	35-107361	VE3-A736	338	35-110668	VE3-B066	750
35-043966	VE3-4396	787	35-045984	VE3-4598	553	35-052173	VE3-5217	658	35-107361	VE3-A736	341	35-110668	VE3-B066	751
35-043966	VE3-4396	789	35-045984	VE3-4598	755	35-052173	VE3-5217	659	35-107378	VE3-A737	338	35-110668	VE3-B066	753
35-043966	VE3-4396	858	35-045991	VE3-4599	191	35-052173	VE3-5217	846	35-107378	VE3-A737	341	35-110675	VE3-B067	231
35-044000	VE3-4400	108	35-045991	VE3-4599	323	35-052173	VE3-5217	847	35-107385	VE3-A738	338	35-110675	VE3-B067	539
35-044000	VE3-4400	110	35-045991	VE3-4599	553	35-052173	VE3-5217	848	35-107385	VE3-A738	341	35-110675	VE3-B067	548
35-044000	VE3-4400	111	35-045991	VE3-4599	755	35-052180	VE3-5218	16	35-107392	VE3-A739	338	35-110675	VE3-B067	549
35-044000	VE3-4400	113	35-046196	VE3-4619	635	35-052180	VE3-5218	639	35-107392	VE3-A739	341	35-110675	VE3-B067	552
35-044000	VE3-4400	114	35-046196	VE3-4619	818	35-052180	VE3-5218	643	35-107408	VE3-A740	338	35-110675	VE3-B067	744
35-044017	VE3-4401	108	35-046202	VE3-4620	635	35-052180	VE3-5218	656	35-107408	VE3-A740	341	35-110675	VE3-B067	750
35-044017	VE3-4401	110	35-046202	VE3-4620	818	35-052180	VE3-5218	657	35-107422	VE3-A742	154	35-110675	VE3-B067	751
35-044017	VE3-4401	111	35-046370	VE3-4637	17	35-052180	VE3-5218	658	35-107439	VE3-A743	154	35-110675	VE3-B067	753
35-044017	VE3-4401	113	35-046370	VE3-4637	74	35-052180	VE3-5218	659	35-107460	VE3-A746	333	35-110682	VE3-B068	231
35-044017	VE3-4401	114	35-046370	VE3-4637	75	35-052180	VE3-5218	846	35-107477	VE3-A747	333	35-110682	VE3-B068	539
35-044024	VE3-4402	13	35-046370	VE3-4637	646	35-052180	VE3-5218	847	35-108177	VE3-A817	20	35-110682	VE3-B068	548
35-044024	VE3-4402	108	35-046370	VE3-4637	653	35-052180	VE3-5218	848	35-108177	VE3-A817	23	35-110682	VE3-B068	549
35-044024	VE3-4402	110	35-046370	VE3-4637	660	35-052210	VE3-5221	759	35-108177	VE3-A817	26	35-110682	VE3-B068	552
35-044024	VE3-4402	111	35-046370	VE3-4637	661	35-052210	VE3-5221	763	35-108177	VE3-A817	72	35-110682	VE3-B068	744
35-044024	VE3-4402	113	35-046370	VE3-4637	662	35-052210	VE3-5221	764	35-108177	VE3-A817	632	35-110682	VE3-B068	750
35-044024	VE3-4402	114	35-046370	VE3-4637	775	35-052227	VE3-5222	759	35-108177	VE3-A817	633	35-110682	VE3-B068	751
35-044024	VE3-4402	155	35-046370	VE3-4637	777	35-052227	VE3-5222	763	35-108177	VE3-A817	634	35-110682	VE3-B068	753
35-044024	VE3-4402	156	35-046370	VE3-4637	791	35-052227	VE3-5222	764	35-108177	VE3-A817	648	35-110736	VE3-B073	272
35-044031	VE3-4403	13	35-046370	VE3-4637	794	35-052746	VE3-5274	201	35-108177	VE3-A817	654	35-110736	VE3-B073	274
35-044031	VE3-4403	108	35-046387	VE3-4638	17	35-052746	VE3-5274	202	35-108177	VE3-A817	663	35-110736	VE3-B073	275
35-044031	VE3-4403	110	35-046387	VE3-4638	74	35-052746	VE3-5274	203	35-108177	VE3-A817	665	35-110736	VE3-B073	302
35-044031	VE3-4403	111	35-046387	VE3-4638	75	35-052746	VE3-5274	568	35-108177	VE3-A817	674	35-110736	VE3-B073	372
35-044031	VE3-4403	113	35-046387	VE3-4638	646	35-052746	VE3-5274	569	35-108177	VE3-A817	773	35-110736	VE3-B073	373
35-044031	VE3-4403	114	35-046387	VE3-4638	653	35-052746	VE3-5274	570	35-108177	VE3-A817	774	35-110736	VE3-B073	374
35-044031	VE3-4403	155	35-046387	VE3-4638	661	35-052753	VE3-5275	201	35-108177	VE3-A817	779	35-110736	VE3-B073	382
35-044031	VE3-4403	156	35-046387	VE3-4638	662	35-052753	VE3-5275	202	35-108177	VE3-A817	780	35-110736	VE3-B073	383
35-044048	VE3-4404	155	35-046387	VE3-4638	775	35-052753	VE3-5275	203	35-108177	VE3-A817	782	35-110736	VE3-B073	756
35-044048	VE3-4404	156	35-046387	VE3-4638	777	35-052753	VE3-5275	568	35-108177	VE3-A817	796	35-110736	VE3-B073	758
35-044055	VE3-4405	155	35-046387	VE3-4638	791	35-052753	VE3-5275	569	35-108177	VE3-A817	799	35-110736	VE3-B073	761
35-044055	VE3-4405	156	35-046387	VE3-4638	794	35-052753	VE3-5275	570	35-108177	VE3-A817	806	35-110736	VE3-B073	772
35-044062	VE3-4406	781	35-046462	VE3-4646	209	35-052777	VE3-5277	588	35-108177	VE3-A817	810	35-110743	VE3-B074	272
35-044062	VE3-4406	786	35-046462	VE3-4646	210	35-052777	VE3-5277	589	35-108177	VE3-A817	815	35-110743	VE3-B074	274
35-044062	VE3-4406	788	35-046462	VE3-4646	559	35-052784	VE3-5278	588	35-108177	VE3-A817	816	35-110743	VE3-B074	275
35-044062	VE3-4406	813	35-046462	VE3-4646	560	35-052784	VE3-5278	589	35-108177	VE3-A817	852	35-110743	VE3-B074	302
35-044062	VE3-4406	859	35-046462	VE3-464										



# New order number – Old order number

New	Old	Page	New	Old	Page	New	Old	Page	New	Old	Page	New	Old	Page
35-110774	VE3-B077	382	35-114673	VE3-B467	317	35-120377	VE3-C037	130	35-136835	VE3-D683	76	35-141105	VE3-E110	540
35-110774	VE3-B077	383	35-114673	VE3-B467	318	35-120377	VE3-C037	161	35-138266	VE3-D826	562	35-141105	VE3-E110	735
35-110774	VE3-B077	756	35-114673	VE3-B467	319	35-120384	VE3-C038	123	35-138266	VE3-D826	563	35-141105	VE3-E110	736
35-110774	VE3-B077	758	35-114673	VE3-B467	504	35-120384	VE3-C038	126	35-138273	VE3-D827	562	35-141105	VE3-E110	739
35-110774	VE3-B077	759	35-114673	VE3-B467	506	35-120384	VE3-C038	128	35-138273	VE3-D827	563	35-141105	VE3-E110	745
35-110774	VE3-B077	761	35-114673	VE3-B467	507	35-120384	VE3-C038	130	35-138297	VE3-D829	562	35-141662	VE3-E166	156
35-110774	VE3-B077	772	35-114673	VE3-B467	508	35-120384	VE3-C038	161	35-138297	VE3-D829	563	35-141662	VE3-E166	157
35-110873	VE3-B087	338	35-114673	VE3-B467	723	35-120407	VE3-C040	14	35-138297	VE3-D829	564	35-141679	VE3-E167	156
35-110873	VE3-B087	341	35-114673	VE3-B467	724	35-120407	VE3-C040	15	35-138303	VE3-D830	562	35-141679	VE3-E167	157
35-110880	VE3-B088	338	35-114673	VE3-B467	725	35-120407	VE3-C040	124	35-138303	VE3-D830	563	35-141761	VE3-E176	144
35-110880	VE3-B088	341	35-114673	VE3-B467	726	35-120407	VE3-C040	126	35-138303	VE3-D830	564	35-141761	VE3-E176	146
35-112716	VE3-B271	148	35-115045	VE3-B504	115	35-120407	VE3-C040	128	35-138310	VE3-D831	563	35-141778	VE3-E177	144
35-113430	VE3-B343	431	35-115045	VE3-B504	118	35-120407	VE3-C040	130	35-138327	VE3-D832	563	35-141778	VE3-E177	146
35-113454	VE3-B345	431	35-115045	VE3-B504	119	35-120407	VE3-C040	161	35-138341	VE3-D834	563	35-141792	VE3-E179	144
35-113454	VE3-B345	432	35-115045	VE3-B504	121	35-120414	VE3-C041	14	35-138341	VE3-D834	564	35-141792	VE3-E179	146
35-113751	VE3-B375	19	35-115045	VE3-B504	160	35-120414	VE3-C041	15	35-138358	VE3-D835	563	35-141808	VE3-E180	144
35-113751	VE3-B375	23	35-115052	VE3-B505	115	35-120414	VE3-C041	124	35-138358	VE3-D835	564	35-141808	VE3-E180	146
35-113751	VE3-B375	633	35-115052	VE3-B505	118	35-120414	VE3-C041	126	35-139362	VE3-D936	453	35-141822	VE3-E182	399
35-113751	VE3-B375	648	35-115052	VE3-B505	119	35-120414	VE3-C041	128	35-139362	VE3-D936	455	35-141822	VE3-E182	401
35-113751	VE3-B375	654	35-115052	VE3-B505	121	35-120414	VE3-C041	130	35-139362	VE3-D936	456	35-141822	VE3-E182	450
35-113751	VE3-B375	663	35-115052	VE3-B505	160	35-120414	VE3-C041	161	35-139362	VE3-D936	457	35-141846	VE3-E184	399
35-113751	VE3-B375	665	35-115069	VE3-B506	115	35-122074	VE3-C207	672	35-139362	VE3-D936	458	35-141846	VE3-E184	401
35-113751	VE3-B375	674	35-115069	VE3-B506	117	35-122074	VE3-C207	673	35-139362	VE3-D936	459	35-141846	VE3-E184	402
35-113751	VE3-B375	779	35-115069	VE3-B506	118	35-122074	VE3-C207	835	35-139379	VE3-D937	453	35-141846	VE3-E184	424
35-113751	VE3-B375	780	35-115069	VE3-B506	120	35-122074	VE3-C207	836	35-139379	VE3-D937	455	35-141846	VE3-E184	425
35-113751	VE3-B375	796	35-115069	VE3-B506	121	35-122074	VE3-C207	837	35-139379	VE3-D937	456	35-141846	VE3-E184	450
35-113751	VE3-B375	799	35-115069	VE3-B506	160	35-122074	VE3-C207	838	35-139379	VE3-D937	457	35-142102	VE3-E210	118
35-113751	VE3-B375	810	35-115076	VE3-B507	115	35-122074	VE3-C207	839	35-139379	VE3-D937	458	35-142102	VE3-E210	120
35-113751	VE3-B375	815	35-115076	VE3-B507	117	35-122074	VE3-C207	840	35-139379	VE3-D937	459	35-142119	VE3-E211	118
35-113751	VE3-B375	816	35-115076	VE3-B507	118	35-122074	VE3-C207	875	35-140207	VE3-E020	240	35-142119	VE3-E211	120
35-113751	VE3-B375	870	35-115076	VE3-B507	120	35-122081	VE3-C208	672	35-140207	VE3-E020	241	35-142287	VE3-E228	453
35-113751	VE3-B375	873	35-115076	VE3-B507	121	35-122081	VE3-C208	673	35-140207	VE3-E020	242	35-142287	VE3-E228	455
35-113768	VE3-B376	20	35-115076	VE3-B507	160	35-122081	VE3-C208	835	35-140207	VE3-E020	519	35-142287	VE3-E228	456
35-113768	VE3-B376	24	35-115106	VE3-B510	13	35-122081	VE3-C208	836	35-140207	VE3-E020	520	35-142287	VE3-E228	457
35-113768	VE3-B376	633	35-115106	VE3-B510	14	35-122081	VE3-C208	837	35-140207	VE3-E020	736	35-142287	VE3-E228	458
35-113768	VE3-B376	648	35-115106	VE3-B510	115	35-122081	VE3-C208	838	35-140214	VE3-E021	240	35-142287	VE3-E228	459
35-113768	VE3-B376	654	35-115106	VE3-B510	117	35-122081	VE3-C208	839	35-140214	VE3-E021	241	35-142294	VE3-E229	453
35-113768	VE3-B376	663	35-115106	VE3-B510	118	35-122081	VE3-C208	840	35-140214	VE3-E021	242	35-142294	VE3-E229	455
35-113768	VE3-B376	665	35-115106	VE3-B510	120	35-122081	VE3-C208	875	35-140214	VE3-E021	519	35-142294	VE3-E229	456
35-113768	VE3-B376	675	35-115106	VE3-B510	121	35-122111	VA3-C211	598	35-140214	VE3-E021	520	35-142294	VE3-E229	457
35-113768	VE3-B376	779	35-115113	VE3-B511	13	35-122111	VA3-C211	599	35-140214	VE3-E021	736	35-142294	VE3-E229	458
35-113768	VE3-B376	780	35-115113	VE3-B511	14	35-122128	VA3-C212	598	35-140238	VE3-E023	11	35-142294	VE3-E229	459
35-113768	VE3-B376	796	35-115113	VE3-B511	115	35-122128	VA3-C212	599	35-140238	VE3-E023	240	35-142454	VE3-E245	123
35-113768	VE3-B376	799	35-115113	VE3-B511	117	35-122135	VA3-C213	598	35-140238	VE3-E023	241	35-142454	VE3-E245	126
35-113768	VE3-B376	810	35-115113	VE3-B511	118	35-122135	VA3-C213	600	35-140238	VE3-E023	242	35-142454	VE3-E245	128
35-113768	VE3-B376	815	35-115113	VE3-B511	120	35-122142	VA3-C214	598	35-140238	VE3-E023	519	35-142461	VE3-E246	123
35-113768	VE3-B376	816	35-115113	VE3-B511	121	35-122142	VA3-C214	600	35-140238	VE3-E023	520	35-142461	VE3-E246	126
35-113768	VE3-B376	871	35-115298	VE3-B529	351	35-122180	VE3-C218	598	35-140238	VE3-E023	736	35-142461	VE3-E246	128
35-113768	VE3-B376	873	35-115298	VE3-B529	332	35-122180	VE3-C218	599	35-140245	VE3-E024	11	35-142478	VE3-E247	124
35-114062	VE3-B406	141	35-115304	VE3-B530	331	35-122197	VE3-C219	598	35-140245	VE3-E024	240	35-142478	VE3-E247	126
35-114062	VE3-B406	143	35-115304	VE3-B530	332	35-122197	VE3-C219	599	35-140245	VE3-E024	241	35-142478	VE3-E247	128
35-114079	VE3-B407	141	35-115311	VE3-B531	331	35-122203	VE3-C220	598	35-140245	VE3-E024	242	35-142485	VE3-E248	124
35-114079	VE3-B407	143	35-115311	VE3-B531	332	35-122203	VE3-C220	600	35-140245	VE3-E024	519	35-142485	VE3-E248	126
35-114086	VE3-B408	141	35-115328	VE3-B532	331	35-122210	VE3-C221	598	35-140245	VE3-E024	520	35-142485	VE3-E248	128
35-114086	VE3-B408	143	35-115328	VE3-B532	332	35-122210	VE3-C221	600	35-140245	VE3-E024	736	35-143291	VE3-E329	99
35-114093	VE3-B409	141	35-115908	VE3-B590	96	35-124092	VE3-C409	156	35-140610	VE3-E061	282	35-143291	VE3-E329	123
35-114093	VE3-B409	143	35-115908	VE3-B590	98	35-124092	VE3-C409	157	35-140610	VE3-E061	283	35-143291	VE3-E329	124
35-114222	VE3-B422	331	35-115908	VE3-B590	99	35-124108	VE3-C410	156	35-140610	VE3-E061	302	35-143291	VE3-E329	128
35-114239	VE3-B423	331	35-115908	VE3-B590	100	35-124108	VE3-C410	157	35-140627	VE3-E062	282	35-143291	VE3-E329	130
35-114253	VE3-B425	331	35-115915	VE3-B591	96	35-124115	VE3-C411	156	35-140627	VE3-E062	302	35-143307	VE3-E330	99
35-114260	VE3-B426	331	35-115915	VE3-B591	98	35-124115	VE3-C411	157	35-140634	VE3-E063	282	35-143307	VE3-E330	123
35-114567	VE3-B456	153	35-115915	VE3-B591	99	35-124122	VE3-C412	156	35-140634	VE3-E063	283	35-143307	VE3-E330	124
35-114574	VE3-B457	153	35-115915	VE3-B591	100	35-124122	VE3-C412	157	35-140634	VE3-E063	302	35-143307	VE3-E330	128
35-114635	VE3-B463	191	35-115939	VE3-B593	96	35-125228	VE3-C522	175	35-140795	VE3-E079	199	35-143307	VE3-E330	130
35-114635	VE3-B463	318	35-115939	VE3-B593	98	35-125228	VE3-C522	585	35-140795	VE3-E079	577	35-143321	VE3-E332	99
35-114635	VE3-B463	504	35-115939	VE3-B593	99	35-128625	VE3-C862	479	35-140801	VE3-E080	199	35-143321	VE3-E332	123
35-114635	VE3-B463	505	35-115939	VE3-B593	100	35-128625	VE3-C862	603	35-140801	VE3-E080	577	35-143321	VE3-E332	128
35-114635	VE3-B463	507	35-115946	VE3-B594	96	35-128649	VE3-C864	479	35-141068	VE3-E106	183	35-143321	VE3-E332	130
35-114635	VE3-B463	508	35-115946	VE3-B594	98	35-128649	VE3-C864	604	35-141068	VE3-E106	320	35-143338	VE3-E333	99
35-114635	VE3-B463	553	35-115946	VE3-B594	99	35-128717	VE3-C871	310	35-141068	VE3-E106	321	35-143338	VE3-E333	123
35-114635	VE3-B463	554	35-115946	VE3-B594	100	35-128717	VE3-C871	311	35-141068	VE3-E106	517	35-143338	VE3-E333	128
35-114635	VE3-B463	723	35-116288	VE3-B628	67	35-132462	VE3-D246	163	35-141068	VE3-E1				



# New order number – Old order number

New	Old	Page	New	Old	Page	New	Old	Page	New	Old	Page	New	Old	Page
35-144984	VE3-E498	773	35-168034	VE3-G803	738	35-192954		750	35-223306		205	35-587743	V36-58774	587
35-144991	VE3-E499	763	35-168560	VE3-G856	15	35-192954		751	35-223627		364	35-591177	V36-59117	589
35-144991	VE3-E499	764	35-168560	VE3-G856	16	35-192954		753	35-223634		364	35-591184	V36-59118	589
35-144991	VE3-E499	773	35-168560	VE3-G856	644	35-192961		164	35-223641		364	35-593744	VE3-59374	597
35-146995	VE3-E699	765	35-168560	VE3-G856	645	35-192961		166	35-223658		364	35-593751	VE3-59375	597
35-156512	VE3-F651	279	35-168560	VE3-G856	655	35-192961		167	35-223993		310	35-603207	VE3-60320	784
35-156529	VE3-F652	279	35-168560	VE3-G856	669	35-192961		539	35-223993		311	35-603207	VE3-60320	812
35-158707	VE3-F870	674	35-168560	VE3-G856	848	35-192961		548	35-224013		310	35-603207	VE3-60320	851
35-158707	VE3-F870	803	35-168560	VE3-G856	876	35-192961		549	35-224013		311	35-603207	VE3-60320	852
35-158707	VE3-F870	805	35-168577	VE3-G857	15	35-192961		552	35-225058		564	35-604525	VE3-60452	786
35-158707	VE3-F870	876	35-168577	VE3-G857	16	35-192961		744	35-225065		564	35-604525	VE3-60452	788
35-158714	VE3-F871	674	35-168577	VE3-G857	644	35-192961		750	35-225089		564	35-604525	VE3-60452	813
35-158714	VE3-F871	803	35-168577	VE3-G857	645	35-192961		751	35-225096		564	35-607885	VE3-60788	635
35-158714	VE3-F871	805	35-168577	VE3-G857	655	35-192961		753	35-225102		564	35-607885	VE3-60788	818
35-158738	VE3-F873	803	35-168577	VE3-G857	669	35-192978		164	35-225119		564	35-623809	VE3-62380	558
35-158738	VE3-F873	805	35-168577	VE3-G857	848	35-192978		166	35-225133		564	35-623809	VE3-62380	559
35-158738	VE3-F873	876	35-168577	VE3-G857	876	35-192978		167	35-225140		564	35-623809	VE3-62380	571
35-158745	VE3-F874	803	35-170631	VE3-H063	157	35-192978		539	35-227526		476	35-623816	VE3-62381	558
35-158745	VE3-F874	805	35-170648	VE3-H064	157	35-192978		548	35-227533		476	35-623816	VE3-62381	559
35-158790	VE3-F879	12	35-170662	VE3-H066	157	35-192978		550	35-228370		678	35-623816	VE3-62381	571
35-158790	VE3-F879	519	35-170679	VE3-H067	157	35-192978		552	35-228370		701	36-129034	FE1-C903	107
35-158806	VE3-F880	12	35-170815	VE3-H081	399	35-192978		744	35-228387		678	36-129034	FE1-C903	110
35-158806	VE3-F880	519	35-170815	VE3-H081	401	35-192978		750	35-228387		701	36-129041	FE1-C904	107
35-164418	VE3-G441	436	35-171294	VE3-H129	153	35-192978		752	35-228417		678	36-129041	FE1-C904	110
35-164418	VE3-G441	451	35-171294	VE3-H129	163	35-192978		753	35-228417		701	36-129041	FE1-C904	114
35-164432	VE3-G443	191	35-171300	VE3-H130	153	35-192985		164	35-228424		678	36-129058	FE1-C905	107
35-164432	VE3-G443	544	35-171300	VE3-H130	163	35-192985		166	35-228424		701	36-129065	FE1-C906	107
35-164432	VE3-G443	545	35-171553	VE3-H155	153	35-192985		167	35-229865		26	36-129065	FE1-C906	111
35-164432	VE3-G443	546	35-171553	VE3-H155	163	35-192985		539	35-229865		28	36-129065	FE1-C906	114
35-164432	VE3-G443	746	35-171560	VE3-H156	153	35-192985		548	35-229865		649	36-129096	FE1-C909	137
35-164432	VE3-G443	747	35-171560	VE3-H156	163	35-192985		550	35-229865		667	36-129119	FE1-C911	140
35-164432	VE3-G443	749	35-171669	VE3-H166	166	35-192985		552	35-229865		668	36-129126	FE1-C912	151
35-164449	VE3-G444	191	35-171669	VE3-H166	180	35-192985		744	35-229865		807	36-129133	FE1-C913	151
35-164449	VE3-G444	544	35-171669	VE3-H166	191	35-192985		750	35-229865		809	36-129157	FE1-C915	151
35-164449	VE3-G444	545	35-171669	VE3-H166	321	35-192985		752	35-229872		26	36-129164	FE1-C916	141
35-164449	VE3-G444	546	35-171669	VE3-H166	322	35-192985		753	35-229872		27	36-129164	FE1-C916	142
35-164449	VE3-G444	746	35-171669	VE3-H166	509	35-193654	VE3-H323	339	35-229872		28	36-129171	FE1-C917	141
35-164449	VE3-G444	747	35-171669	VE3-H166	510	35-193661	VE3-H324	339	35-229872		649	36-129171	FE1-C917	142
35-164449	VE3-G444	749	35-171669	VE3-H166	554	35-195047		10	35-229872		667	36-129188	FE1-C918	151
35-164456	VE3-G445	191	35-171669	VE3-H166	726	35-195047		224	35-229872		668	36-129195	FE1-C919	151
35-164456	VE3-G445	544	35-171669	VE3-H166	727	35-195047		257	35-229872		807	36-129201	FE1-C920	151
35-164456	VE3-G445	545	35-171669	VE3-H166	756	35-195054		10	35-229872		808	36-129249	FE1-C924	117
35-164456	VE3-G445	547	35-171676	VE3-H167	166	35-195054		224	35-229872		809	36-129249	FE1-C924	117
35-164456	VE3-G445	746	35-171676	VE3-H167	180	35-195054		257	35-229902		27	36-129249	FE1-C924	120
35-164456	VE3-G445	748	35-171676	VE3-H167	191	35-195078		10	35-229902		28	36-129256	FE1-C925	115
35-164456	VE3-G445	749	35-171676	VE3-H167	321	35-195078		224	35-229902		649	36-129256	FE1-C925	117
35-164463	VE3-G446	191	35-171676	VE3-H167	322	35-195078		257	35-229902		667	36-129256	FE1-C925	119
35-164463	VE3-G446	544	35-171676	VE3-H167	509	35-195085		10	35-229902		668	36-129256	FE1-C925	120
35-164463	VE3-G446	545	35-171676	VE3-H167	510	35-195085		224	35-229902		808	36-129256	FE1-C925	121
35-164463	VE3-G446	547	35-171676	VE3-H167	554	35-195085		257	35-229902		809	36-129263	FE1-C926	104
35-164463	VE3-G446	746	35-171676	VE3-H167	726	35-195276		589	35-229919		27	36-129263	FE1-C926	106
35-164463	VE3-G446	748	35-171676	VE3-H167	727	35-195276		590	35-229919		28	36-129270	FE1-C927	136
35-164463	VE3-G446	749	35-171676	VE3-H167	756	35-195283		589	35-229919		649	36-129300	FE1-C930	104
35-165453	VE3-G545	570	35-171690	VE3-H169	166	35-195283		590	35-229919		650	36-129300	FE1-C930	106
35-165453	VE3-G545	571	35-171690	VE3-H169	180	35-195382		457	35-229919		667	36-129348	FE1-C934	149
35-165675	VE3-G567	570	35-171690	VE3-H169	191	35-195382		459	35-229919		668	36-129416	FE1-C941	407
35-165675	VE3-G567	571	35-171690	VE3-H169	321	35-195399		457	35-229919		669	36-129416	FE1-C941	412
35-166856	VE3-G685	613	35-171690	VE3-H169	322	35-195399		459	35-229919		808	36-129416	FE1-C941	414
35-166856	VE3-G685	614	35-171690	VE3-H169	509	35-196389		339	35-229919		809	36-129447	FE1-C944	383
35-166863	VE3-G686	423	35-171690	VE3-H169	510	35-197157		154	35-231172		509	36-129454	FE1-C945	383
35-166863	VE3-G686	424	35-171690	VE3-H169	554	35-197195		154	35-231172		727	36-129461	FE1-C946	388
35-166863	VE3-G686	451	35-171690	VE3-H169	726	35-197263		406	35-231189		509	36-129478	FE1-C947	388
35-166887	VE3-G688	423	35-171690	VE3-H169	727	35-197263		407	35-231189		727	36-129478	FE1-C947	389
35-166887	VE3-G688	424	35-171690	VE3-H169	756	35-197348		339	35-231646		578	36-129485	FE1-C948	388
35-166887	VE3-G688	451	35-171706	VE3-H170	166	35-207207		101	35-232582		339	36-129485	FE1-C948	415
35-167990	VE3-G799	166	35-171706	VE3-H170	180	35-207207		102	35-232582		340	36-129485	FE1-C948	418
35-167990	VE3-G799	167	35-171706	VE3-H170	191	35-207207		131	35-232599		339	36-129508	FE1-C950	388
35-167990	VE3-G799	183	35-171706	VE3-H170	321	35-207214		101	35-232599		340	36-129508	FE1-C950	389
35-167990	VE3-G799	191	35-171706	VE3-H170	322	35-207214		102	35-232872	VE3-C343	221	36-129515	FE1-C951	388
35-167990	VE3-G799	521	35-171706	VE3-H170	509	35-207214		131	35-232889	VE3-C344	221	36-129515	FE1-C951	389
35-167990	VE3-G799	522	35-171706	VE3-H170	510	35-207481		101	35-233091		274	36-129546	FE1-C954	428
35-167990	VE3-G799	523	35-171706	VE3-H170	554	35-207481		102	35-233107		274	36-129553	FE1-C955	428
35-167990	VE3-G799	737	35-171706	VE3-H170	726	35-207481		131	35-233312	V36-0808	257	36-129577	FE1-C957	427
35-167990	VE3-G799	738	35-171706	VE3-H170	727	35-207504		101	35-233596		109	36-129577	FE1-C957	428
35-168003	VE3-G800	166	35-171706	VE3-H170	756	35-207504		102	35-233596		110	36-129584	FE1-C958	414
35-168003	VE3-G800	167	35-176862	VE3-H686	200	35-207504		131	35-233596		112	36-129584	FE1-C958	418
35-168003	VE3-G800	183	35-176879	VE3-H687	200	35-209652		604	35-233602		109	36-129591	FE1-C959	415
35-168003	VE3-G800	191	35-176893	VE3-H689	200	35								



# New order number – Old order number

New	Old	Page	New	Old	Page	New	Old	Page	New	Old	Page	New	Old	Page
36-129744	FE1-C974	426	36-130153	FE1-D015	498	36-130511	FE1-D051	618	36-131020	FE1-D102	89	36-133352	FE1-D335	285
36-129744	FE1-C974	427	36-130153	FE1-D015	499	36-130528	FE1-D052	616	36-131044	FE1-D104	16	36-133369	FE1-D336	259
36-129768	FE1-C976	387	36-130153	FE1-D015	500	36-130528	FE1-D052	617	36-131044	FE1-D104	17	36-133376	FE1-D337	259
36-129775	FE1-C977	387	36-130153	FE1-D015	501	36-130535	FE1-D053	616	36-131068	FE1-D106	783	36-133376	FE1-D337	259
36-129812	FE1-C981	387	36-130153	FE1-D015	502	36-130542	FE1-D054	601	36-131082	FE1-D108	820	36-133376	FE1-D337	259
36-129829	FE1-C982	257	36-130153	FE1-D015	543	36-130542	FE1-D054	602	36-131082	FE1-D108	821	36-133383	FE1-D338	261
36-129829	FE1-C982	258	36-130153	FE1-D015	544	36-130559	FE1-D055	601	36-131082	FE1-D108	822	36-133383	FE1-D338	262
36-129829	FE1-C982	259	36-130153	FE1-D015	545	36-130573	FE1-D057	609	36-131105	FE1-D110	783	36-133383	FE1-D338	263
36-129829	FE1-C982	260	36-130153	FE1-D015	546	36-130573	FE1-D057	610	36-131105	FE1-D110	851	36-133383	FE1-D338	285
36-129829	FE1-C982	285	36-130153	FE1-D015	552	36-130580	FE1-D058	611	36-131112	FE1-D111	636	36-133390	FE1-D339	260
36-129836	FE1-C983	288	36-130153	FE1-D015	718	36-130580	FE1-D058	615	36-131112	FE1-D111	637	36-133390	FE1-D339	261
36-129836	FE1-C983	289	36-130153	FE1-D015	719	36-130597	FE1-D059	609	36-131112	FE1-D111	641	36-133390	FE1-D339	262
36-129836	FE1-C983	290	36-130153	FE1-D015	720	36-130597	FE1-D059	610	36-131112	FE1-D111	652	36-133390	FE1-D339	263
36-129843	FE1-C984	286	36-130153	FE1-D015	721	36-130603	FE1-D060	602	36-131112	FE1-D111	786	36-133390	FE1-D339	285
36-129843	FE1-C984	287	36-130153	FE1-D015	722	36-130603	FE1-D060	603	36-131112	FE1-D111	788	36-133406	FE1-D340	261
36-129850	FE1-C985	286	36-130153	FE1-D015	746	36-130610	FE1-D061	602	36-131112	FE1-D111	857	36-133406	FE1-D340	262
36-129850	FE1-C985	287	36-130153	FE1-D015	747	36-130610	FE1-D061	603	36-131129	FE1-D112	60	36-133406	FE1-D340	263
36-129867	FE1-C986	286	36-130153	FE1-D015	748	36-130627	FE1-D062	369	36-131129	FE1-D112	89	36-133406	FE1-D340	285
36-129867	FE1-C986	287	36-130153	FE1-D015	754	36-130634	FE1-D063	369	36-131143	FE1-D114	786	36-133413	FE1-D341	263
36-129874	FE1-C987	288	36-130160	FE1-D016	316	36-130658	FE1-D065	637	36-131143	FE1-D114	857	36-133413	FE1-D341	264
36-129874	FE1-C987	289	36-130160	FE1-D016	317	36-130658	FE1-D065	638	36-131167	FE1-D116	61	36-133413	FE1-D341	265
36-129874	FE1-C987	290	36-130160	FE1-D016	498	36-130665	FE1-D066	785	36-131167	FE1-D116	64	36-133420	FE1-D342	263
36-129898	FE1-C989	259	36-130160	FE1-D016	499	36-130665	FE1-D066	813	36-131167	FE1-D116	826	36-133420	FE1-D342	264
36-129898	FE1-C989	260	36-130160	FE1-D016	500	36-130665	FE1-D066	874	36-131167	FE1-D116	828	36-133420	FE1-D342	265
36-129904	FE1-C990	261	36-130160	FE1-D016	501	36-130672	FE1-D067	82	36-131181	FE1-D118	60	36-133437	FE1-D343	267
36-129904	FE1-C990	262	36-130160	FE1-D016	502	36-130689	FE1-D068	82	36-131181	FE1-D118	88	36-133437	FE1-D343	269
36-129904	FE1-C990	285	36-130160	FE1-D016	543	36-130719	FE1-D071	86	36-131181	FE1-D118	89	36-133451	FE1-D345	281
36-129911	FE1-C991	260	36-130160	FE1-D016	544	36-130719	FE1-D071	87	36-131228	FE1-D122	653	36-133468	FE1-D346	281
36-129911	FE1-C991	261	36-130160	FE1-D016	545	36-130719	FE1-D071	88	36-131228	FE1-D122	660	36-133468	FE1-D346	303
36-129911	FE1-C991	262	36-130160	FE1-D016	546	36-130719	FE1-D071	91	36-131228	FE1-D122	790	36-133475	FE1-D347	281
36-129911	FE1-C991	285	36-130160	FE1-D016	552	36-130726	FE1-D072	29	36-131228	FE1-D122	791	36-133505	FE1-D350	285
36-129928	FE1-C992	280	36-130160	FE1-D016	718	36-130726	FE1-D072	90	36-131228	FE1-D122	819	36-133529	FE1-D352	261
36-129928	FE1-C992	303	36-130160	FE1-D016	719	36-130733	FE1-D073	29	36-131228	FE1-D122	870	36-133529	FE1-D352	262
36-129935	FE1-C993	280	36-130160	FE1-D016	720	36-130757	FE1-D075	85	36-131287	FE1-D128	64	36-133529	FE1-D352	285
36-129935	FE1-C993	303	36-130160	FE1-D016	721	36-130757	FE1-D075	86	36-131287	FE1-D129	646	36-133550	FE1-D355	287
36-129942	FE1-C994	280	36-130160	FE1-D016	722	36-130757	FE1-D075	87	36-131297	FE1-D129	653	36-133567	FE1-D356	288
36-129959	FE1-C995	280	36-130160	FE1-D016	746	36-130757	FE1-D075	88	36-131297	FE1-D129	660	36-133574	FE1-D357	288
36-129959	FE1-C995	281	36-130160	FE1-D016	747	36-130757	FE1-D075	90	36-131297	FE1-D129	662	36-133574	FE1-D357	289
36-129959	FE1-C995	303	36-130160	FE1-D016	748	36-130771	FE1-D077	79	36-131297	FE1-D129	670	36-133635	FE1-D363	388
36-129966	FE1-C996	281	36-130160	FE1-D016	755	36-130771	FE1-D077	80	36-131297	FE1-D129	671	36-133635	FE1-D363	389
36-129980	FE1-C998	281	36-130177	FE1-D017	539	36-130771	FE1-D077	81	36-131297	FE1-D129	774	36-133642	FE1-D364	388
36-129980	FE1-C998	303	36-130177	FE1-D017	745	36-130771	FE1-D077	84	36-131297	FE1-D129	776	36-133659	FE1-D365	388
36-129997	FE1-C999	281	36-130214	FE1-D021	323	36-130788	FE1-D078	823	36-131297	FE1-D129	778	36-133659	FE1-D365	390
36-130016	FE1-D001	281	36-130214	FE1-D021	544	36-130795	FE1-D079	823	36-131297	FE1-D129	790	36-133659	FE1-D365	391
36-130016	FE1-D001	303	36-130214	FE1-D021	545	36-130795	FE1-D079	825	36-131297	FE1-D129	791	36-133659	FE1-D365	394
36-130023	FE1-D002	281	36-130214	FE1-D021	546	36-130795	FE1-D079	850	36-131297	FE1-D129	793	36-133659	FE1-D365	395
36-130023	FE1-D002	303	36-130214	FE1-D021	552	36-130801	FE1-D080	823	36-131297	FE1-D129	818	36-133659	FE1-D365	403
36-130030	FE1-D003	267	36-130214	FE1-D021	746	36-130801	FE1-D080	825	36-131358	FE1-D135	29	36-133666	FE1-D366	388
36-130047	FE1-D004	278	36-130214	FE1-D021	747	36-130801	FE1-D080	850	36-131358	FE1-D135	33	36-133666	FE1-D366	431
36-130047	FE1-D004	279	36-130214	FE1-D021	748	36-130818	FE1-D081	636	36-131358	FE1-D135	33	36-133673	FE1-D367	388
36-130054	FE1-D005	278	36-130214	FE1-D021	755	36-130818	FE1-D081	637	36-133048	FE1-D304	61	36-133673	FE1-D367	402
36-130078	FE1-D007	263	36-130221	FE1-D022	534	36-130818	FE1-D081	641	36-133048	FE1-D304	64	36-133673	FE1-D367	415
36-130078	FE1-D007	264	36-130221	FE1-D022	535	36-130818	FE1-D081	652	36-133055	FE1-D305	795	36-133697	FE1-D369	388
36-130085	FE1-D008	263	36-130221	FE1-D022	742	36-130818	FE1-D081	786	36-133055	FE1-D305	800	36-133703	FE1-D370	388
36-130085	FE1-D008	264	36-130252	FE1-D025	543	36-130818	FE1-D081	789	36-133055	FE1-D305	801	36-133703	FE1-D370	389
36-130085	FE1-D008	265	36-130252	FE1-D025	544	36-130818	FE1-D081	857	36-133055	FE1-D305	802	36-133796	FE1-D379	410
36-130092	FE1-D009	263	36-130252	FE1-D025	545	36-130825	FE1-D082	636	36-133055	FE1-D305	870	36-133796	FE1-D379	411
36-130092	FE1-D009	264	36-130252	FE1-D025	746	36-130825	FE1-D082	641	36-133055	FE1-D305	872	36-133833	FE1-D383	409
36-130092	FE1-D009	265	36-130252	FE1-D025	747	36-130825	FE1-D082	652	36-133062	FE1-D306	82	36-133833	FE1-D383	410
36-130108	FE1-D010	177	36-130269	FE1-D026	546	36-130825	FE1-D082	786	36-133093	FE1-D309	85	36-133833	FE1-D383	426
36-130108	FE1-D010	178	36-130269	FE1-D026	748	36-130825	FE1-D082	788	36-133109	FE1-D310	85	36-133840	FE1-D384	426
36-130108	FE1-D010	515	36-130337	FE1-D033	177	36-130825	FE1-D082	790	36-133109	FE1-D310	86	36-133840	FE1-D384	427
36-130108	FE1-D010	516	36-130337	FE1-D033	515	36-130825	FE1-D082	793	36-133109	FE1-D310	87	36-133857	FE1-D385	426
36-130108	FE1-D010	732	36-130337	FE1-D033	516	36-130825	FE1-D082	857	36-133116	FE1-D311	86	36-133857	FE1-D385	427
36-130115	FE1-D011	493	36-130337	FE1-D033	732	36-130832	FE1-D083	791	36-133116	FE1-D311	90	36-133864	FE1-D386	426
36-130115	FE1-D011	494	36-130399	FE1-D039	526	36-130832	FE1-D083	823	36-133123	FE1-D312	86	36-133864	FE1-D386	427
36-130115	FE1-D011	495	36-130399	FE1-D039	527	36-130832	FE1-D083	825	36-133123	FE1-D312	90	36-133918	FE1-D391	181
36-130115	FE1-D011	496	36-130399	FE1-D039	528	36-130832	FE1-D083	850	36-133123	FE1-D312	91	36-133918	FE1-D391	526
36-130115	FE1-D011	497	36-130399	FE1-D039	529	36-130849	FE1-D084	823	36-133130	FE1-D313	87	36-133918	FE1-D391	527
36-130115	FE1-D011	716	36-130399	FE1-D039	712	36-130849	FE1-D084	825	36-133130	FE1-D313	88	36-133918	FE1-D391	529
36-130115	FE1-D011	717	36-130399	FE1-D039	713	36-130856	FE1-D085	823	36-133130	FE1-D313	91	36-133918	FE1-D391	712
36-130122	FE1-D012	493	36-130412	FE1-D041	541	36-130856	FE1-D085	825	36-133147	FE1-D314	5			



# New order number – Old order number

New	Old	Page	New	Old	Page	New	Old	Page	New	Old	Page	New	Old	Page
36-134007	FE1-D400	532	36-147793	FE1-E779	22	36-153978	FE1-F397	150	36-159055	FE1-F905	265	36-161096	FE1-G109	368
36-134007	FE1-D400	533	36-147793	FE1-E779	23	36-154029	FE1-F402	389	36-159062	FE1-F906	267	36-161157	FE1-G115	541
36-134007	FE1-D400	728	36-147854	FE1-E785	36	36-154036	FE1-F403	389	36-159123	FE1-F912	259	36-161157	FE1-G115	542
36-134014	FE1-D401	534	36-147861	FE1-E786	36	36-154050	FE1-F405	428	36-159192	FE1-F919	289	36-161317	FE1-G131	99
36-134014	FE1-D401	535	36-147861	FE1-E786	37	36-154067	FE1-F406	428	36-159192	FE1-F919	290	36-161317	FE1-G131	127
36-134014	FE1-D401	742	36-147878	FE1-E787	37	36-154104	FE1-F410	389	36-159208	FE1-F920	278	36-161324	FE1-G132	123
36-134021	FE1-D402	534	36-147878	FE1-E787	38	36-154104	FE1-F410	390	36-159208	FE1-F920	279	36-161324	FE1-G132	129
36-134021	FE1-D402	535	36-147885	FE1-E788	37	36-154104	FE1-F410	391	36-159260	FE1-F926	266	36-161331	FE1-G133	96
36-134021	FE1-D402	742	36-147885	FE1-E788	40	36-154104	FE1-F410	402	36-159345	FE1-F934	258	36-161331	FE1-G133	100
36-134038	FE1-D403	534	36-147885	FE1-E788	44	36-154104	FE1-F410	403	36-159345	FE1-F934	285	36-161331	FE1-G133	122
36-134038	FE1-D403	535	36-147885	FE1-E788	45	36-154135	FE1-F413	419	36-159369	FE1-F936	387	36-161331	FE1-G133	123
36-134038	FE1-D403	742	36-147885	FE1-E788	46	36-154142	FE1-F414	419	36-159383	FE1-F938	387	36-161355	FE1-G135	96
36-134045	FE1-D404	534	36-147892	FE1-E789	37	36-154159	FE1-F415	419	36-159413	FE1-F941	435	36-161355	FE1-G135	97
36-134045	FE1-D404	535	36-147892	FE1-E789	38	36-154197	FE1-F419	435	36-159451	FE1-F945	388	36-161355	FE1-G135	98
36-134045	FE1-D404	742	36-147892	FE1-E789	40	36-154203	FE1-F420	435	36-159451	FE1-F945	389	36-161355	FE1-G135	99
36-134045	FE1-D404	743	36-147892	FE1-E789	41	36-154210	FE1-F421	434	36-159505	FE1-F950	430	36-161355	FE1-G135	100
36-134076	FE1-D407	632	36-147892	FE1-E789	44	36-154210	FE1-F421	435	36-159529	FE1-F952	430	36-161355	FE1-G135	122
36-134076	FE1-D407	663	36-147892	FE1-E789	45	36-154227	FE1-F422	426	36-159543	FE1-F954	430	36-161355	FE1-G135	123
36-134076	FE1-D407	674	36-147892	FE1-E789	46	36-154234	FE1-F423	435	36-159550	FE1-F955	430	36-161355	FE1-G135	127
36-134076	FE1-D407	795	36-147908	FE1-E790	40	36-154241	FE1-F424	410	36-159574	FE1-F957	389	36-161379	FE1-G137	95
36-134076	FE1-D407	799	36-147908	FE1-E790	41	36-154241	FE1-F424	411	36-159581	FE1-F958	389	36-161379	FE1-G137	96
36-134076	FE1-D407	806	36-147908	FE1-E790	45	36-154289	FE1-F428	266	36-159598	FE1-F959	389	36-161379	FE1-G137	97
36-134076	FE1-D407	809	36-147908	FE1-E790	47	36-154299	FE1-F428	268	36-159604	FE1-F960	388	36-161379	FE1-G137	99
36-134083	FE1-D408	636	36-147908	FE1-E790	48	36-154296	FE1-F429	270	36-159604	FE1-F960	389	36-161379	FE1-G137	122
36-134083	FE1-D408	637	36-147908	FE1-E790	49	36-154302	FE1-F430	270	36-159611	FE1-F961	389	36-161379	FE1-G137	127
36-134083	FE1-D408	638	36-147908	FE1-E790	50	36-154302	FE1-F430	271	36-159642	FE1-F964	147	36-161393	FE1-G139	95
36-134083	FE1-D408	642	36-147915	FE1-E791	37	36-154319	FE1-F431	287	36-159659	FE1-F965	147	36-161393	FE1-G139	96
36-134083	FE1-D408	843	36-147915	FE1-E791	40	36-154326	FE1-F432	270	36-159710	FE1-F971	103	36-161393	FE1-G139	97
36-134083	FE1-D408	844	36-147915	FE1-E791	41	36-154326	FE1-F432	271	36-159741	FE1-F974	103	36-161393	FE1-G139	99
36-134106	FE1-D410	642	36-147915	FE1-E791	45	36-154340	FE1-F434	266	36-159741	FE1-F974	104	36-161393	FE1-G139	127
36-134106	FE1-D410	843	36-147915	FE1-E791	47	36-154357	FE1-F435	271	36-159819	FE1-F981	103	36-161409	FE1-G140	144
36-134106	FE1-D410	844	36-147915	FE1-E791	48	36-154364	FE1-F436	287	36-159819	FE1-F981	104	36-161416	FE1-G141	181
36-134106	FE1-D410	845	36-147915	FE1-E791	49	36-154364	FE1-F436	288	36-159826	FE1-F982	134	36-161416	FE1-G141	526
36-134113	FE1-D411	645	36-147915	FE1-E791	50	36-154388	FE1-F438	287	36-159826	FE1-F982	135	36-161416	FE1-G141	528
36-134113	FE1-D411	646	36-147977	FE1-E797	37	36-154388	FE1-F438	288	36-159826	FE1-F982	147	36-161416	FE1-G141	712
36-134113	FE1-D411	653	36-147984	FE1-E798	37	36-154432	FE1-F443	267	36-159895	FE1-F989	375	36-161447	FE1-G144	177
36-134113	FE1-D411	790	36-147991	FE1-E799	37	36-154432	FE1-F443	269	36-159901	FE1-F990	375	36-161447	FE1-G144	320
36-134113	FE1-D411	791	36-147991	FE1-E799	38	36-154432	FE1-F443	286	36-159901	FE1-F990	376	36-161447	FE1-G144	515
36-134113	FE1-D411	818	36-148004	FE1-E800	37	36-154449	FE1-F444	286	36-159932	FE1-F993	375	36-161447	FE1-G144	732
36-134113	FE1-D411	819	36-148004	FE1-E800	40	36-154456	FE1-F445	271	36-159949	FE1-F994	375	36-161485	FE1-G148	144
36-134113	FE1-D411	870	36-148004	FE1-E800	44	36-154487	FE1-F448	498	36-159949	FE1-F994	376	36-161539	FE1-G153	183
36-134137	FE1-D413	774	36-148004	FE1-E800	45	36-154487	FE1-F448	499	36-159987	FE1-F998	629	36-161539	FE1-G153	491
36-134137	FE1-D413	775	36-148004	FE1-E800	46	36-154487	FE1-F448	500	36-159987	FE1-F998	630	36-161539	FE1-G153	492
36-134151	FE1-D415	77	36-148004	FE1-E800	47	36-154487	FE1-F448	502	36-160051	FE1-G005	9	36-161553	FE1-G155	454
36-134151	FE1-D415	781	36-148011	FE1-E801	37	36-154487	FE1-F448	718	36-160099	FE1-G009	9	36-161560	FE1-G156	183
36-134151	FE1-D415	840	36-148011	FE1-E801	38	36-154487	FE1-F448	719	36-160150	FE1-G015	216	36-161560	FE1-G156	491
36-134175	FE1-D417	783	36-148011	FE1-E801	40	36-154487	FE1-F448	720	36-160150	FE1-G015	217	36-161560	FE1-G156	492
36-134199	FE1-D419	778	36-148011	FE1-E801	41	36-154531	FE1-F453	512	36-160150	FE1-G015	356	36-161614	FE1-G161	694
36-134199	FE1-D419	785	36-148011	FE1-E801	45	36-154531	FE1-F453	513	36-160150	FE1-G015	366	36-161614	FE1-G161	695
36-134243	FE1-D424	784	36-148011	FE1-E801	46	36-154531	FE1-F453	514	36-160150	FE1-G015	609	36-161614	FE1-G161	696
36-134243	FE1-D424	812	36-148011	FE1-E801	47	36-154531	FE1-F453	740	36-160150	FE1-G015	615	36-161638	FE1-G163	694
36-134250	FE1-D425	635	36-148028	FE1-E802	40	36-154531	FE1-F453	741	36-160167	FE1-G016	479	36-161638	FE1-G163	695
36-134250	FE1-D425	778	36-148028	FE1-E802	41	36-154654	FE1-F465	208	36-160167	FE1-G016	603	36-161638	FE1-G163	696
36-134250	FE1-D425	818	36-148028	FE1-E802	48	36-154654	FE1-F465	556	36-160174	FE1-G017	216	36-161638	FE1-G163	696
36-134267	FE1-D426	818	36-148028	FE1-E802	49	36-154654	FE1-F465	560	36-160174	FE1-G017	217	36-161652	FE1-G165	705
36-134281	FE1-D428	820	36-148028	FE1-E802	50	36-154661	FE1-F466	208	36-160174	FE1-G017	356	36-161690	FE1-G169	481
36-134281	FE1-D428	822	36-148035	FE1-E803	41	36-154661	FE1-F466	556	36-160174	FE1-G017	609	36-161720	FE1-G172	480
36-134298	FE1-D429	78	36-148035	FE1-E803	43	36-154661	FE1-F466	559	36-160181	FE1-G018	216	36-161720	FE1-G172	481
36-134298	FE1-D429	820	36-148066	FE1-E806	267	36-154661	FE1-F466	560	36-160181	FE1-G018	366	36-161843	FE1-G184	453
36-134298	FE1-D429	821	36-148066	FE1-E806	268	36-154678	FE1-F467	559	36-160181	FE1-G018	609	36-161843	FE1-G184	453
36-134298	FE1-D429	822	36-148066	FE1-E806	269	36-154678	FE1-F467	560	36-160181	FE1-G018	609	36-161980	FE1-G198	453
36-134298	FE1-D429	849	36-148073	FE1-E807	479	36-154692	FE1-F469	235	36-160204	FE1-G020	125	36-161997	FE1-G199	453
36-134311	FE1-D431	821	36-148073	FE1-E807	614	36-154692	FE1-F469	650	36-160204	FE1-G020	126	36-162017	FE1-G201	149
36-134335	FE1-D433	432	36-148080	FE1-E808	479	36-154692	FE1-F469	651	36-160211	FE1-G021	601	36-162055	FE1-G205	149
36-134397	FE1-D439	78	36-148080	FE1-E808	603	36-154708	FE1-F470	247	36-160211	FE1-G021	602	36-162451	FE1-G245	546
36-134397	FE1-D439	83	36-148080	FE1-E808	614	36-154760	FE1-F476	757	36-160228	FE1-G022	125	36-162451	FE1-G245	748
36-134397	FE1-D439	821	36-148134	FE1-E813	795	36-154784	FE1-F478	757	36-160235	FE1-G023	130	36-162468	FE1-G246	543
36-134397	FE1-D439	822	36-148158	FE1-E815	664	36-154791	FE1-F479	767	36-160235	FE1-G023	130	36-162468	FE1-G246	544
36-134397	FE1-D439	849	36-148158	FE1-E815	665	36-154814	FE1-F481	328	36-160242	FE1-G024	85	36-162468	FE1-G246	545
36-134410	FE1-D441	826	36-148158	FE1-E815	799	36-154814	FE1-F481	329	36-160273	FE1-G027	85	36-162468	FE1-G246	546
36-134427	FE1-D442	826	36-148158	FE1-E815	804	36-154821	FE1-F482	382	36-160303	FE1-G030	817	36-162468	FE1-G246	546
36-134427	FE1-D442	827	36-148158	FE1-E815	805	36-154845	FE1-F484	459	36-160396	FE1-G039	71	36-162468	FE1-G2	



# New order number – Old order number

New	Old	Page	New	Old	Page	New	Old	Page	New	Old	Page	New	Old	Page
36-163281	FE1-G328	660	36-172283	FE1-H228	398	36-198054		477	36-199662		834	36-200283		483
36-163298	FE1-G329	660	36-172283	FE1-H228	400	36-198078		489	36-199662		835	36-200306		474
36-163304	FE1-G330	660	36-172382	FE1-H238	400	36-198078		555	36-199662		836	36-200313		697
36-163342	FE1-G334	625	36-174041	FE1-H404	154	36-198078		623	36-199662		854	36-200313		698
36-163359	FE1-G335	625	36-191536		248	36-198078		624	36-199679		673	36-200337		697
36-163595	FE1-G359	485	36-191598		47	36-198085		477	36-199679		836	36-200337		698
36-163595	FE1-G359	486	36-191598		50	36-198092		477	36-199686		250	36-200344		697
36-163601	FE1-G360	481	36-195428		3	36-198092		478	36-199686		251	36-200344		698
36-163601	FE1-G360	482	36-195428		4	36-198108		477	36-199693		279	36-200351		699
36-163632	FE1-G363	481	36-195428		5	36-198122		478	36-199709		250	36-200351		700
36-163632	FE1-G363	482	36-195428		6	36-198139		605	36-199709		251	36-200375		700
36-163656	FE1-G365	477	36-195428		7	36-198153		194	36-199716		201	36-200382		701
36-163663	FE1-G366	477	36-195428		11	36-198153		195	36-199716		202	36-200399		707
36-163670	FE1-G367	477	36-195435		3	36-198153		197	36-199723		201	36-200429		226
36-163700	FE1-G370	477	36-195435		11	36-198153		579	36-199723		202	36-200436		226
36-163717	FE1-G371	477	36-195442		3	36-198184		194	36-199723		203	36-200443		697
36-163731	FE1-G373	419	36-195442		11	36-198184		195	36-199730		201	36-200443		698
36-163793	FE1-G379	393	36-195596		2	36-198184		196	36-199730		202	36-200450		474
36-163816	FE1-G381	390	36-195619		4	36-198184		197	36-199730		203	36-200481		707
36-163816	FE1-G381	391	36-195619		11	36-198184		579	36-199747		201	36-200498		333
36-163823	FE1-G382	382	36-195640		5	36-198191		195	36-199747		202	36-200504		332
36-163854	FE1-G385	329	36-195640		6	36-198191		197	36-199754		201	36-200511		484
36-163854	FE1-G385	330	36-195657		5	36-198207		699	36-199754		202	36-200528		484
36-163878	FE1-G387	328	36-195657		6	36-198207		700	36-199761		201	36-200542		461
36-163878	FE1-G387	329	36-195664		5	36-198221		194	36-199761		202	36-200542		600
36-163878	FE1-G387	625	36-195664		6	36-198221		195	36-199785		201	36-200559		707
36-163991	FE1-G399	270	36-195671		5	36-198221		196	36-199785		202	36-200566		474
36-163991	FE1-G399	271	36-195671		7	36-198221		197	36-199785		203	36-200573		472
36-164011	FE1-G401	266	36-195688		5	36-198221		211	36-199808		201	36-200573		473
36-164127	FE1-G412	244	36-195688		7	36-198245		210	36-199808		202	36-200580		195
36-164134	FE1-G413	244	36-195718		6	36-198245		561	36-199808		203	36-200580		197
36-164141	FE1-G414	230	36-195718		7	36-198252		195	36-199815		672	36-200580		210
36-164158	FE1-G415	230	36-195749		6	36-198252		197	36-199815		834	36-200580		211
36-164158	FE1-G415	244	36-195749		7	36-198269		197	36-199815		836	36-200580		579
36-164165	FE1-G416	221	36-195756		5	36-198269		210	36-199822		68	36-200597		697
36-164172	FE1-G417	221	36-195756		7	36-198276		194	36-199839		672	36-200597		698
36-164189	FE1-G418	221	36-195763		71	36-198276		196	36-199839		673	36-200610		250
36-164196	FE1-G419	199	36-195770		71	36-198313		477	36-199839		834	36-200610		251
36-164196	FE1-G419	200	36-195794		81	36-198320		607	36-199839		836	36-200610		279
36-164202	FE1-G420	198	36-195848		29	36-198320		608	36-199846		672	36-200627		473
36-164202	FE1-G420	199	36-195848		831	36-198337		476	36-199846		834	36-200634		250
36-164264	FE1-G426	155	36-195893		74	36-198337		606	36-199846		854	36-200634		279
36-164271	FE1-G427	155	36-195909		73	36-198344		759	36-199853		531	36-200641		227
36-164288	FE1-G428	155	36-195909		74	36-198351		397	36-199853		739	36-200641		228
36-164301	FE1-G430	768	36-195916		73	36-198358		195	36-199860		183	36-200641		229
36-164301	FE1-G430	769	36-195916		74	36-198368		579	36-199860		531	36-200658		472
36-164301	FE1-G430	772	36-195916		75	36-198375		418	36-199860		739	36-200658		473
36-164318	FE1-G431	221	36-195923		73	36-198658		637	36-199877		68	36-200658		474
36-164318	FE1-G431	526	36-195923		74	36-199358		599	36-199884		670	36-200672		699
36-164318	FE1-G431	528	36-195930		73	36-199358		854	36-199884		671	36-200672		700
36-164318	FE1-G431	529	36-195930		74	36-199365		599	36-199891		233	36-200689		701
36-164318	FE1-G431	712	36-195930		75	36-199365		855	36-199891		234	36-200702		474
36-164318	FE1-G431	713	36-195947		73	36-199372		599	36-199907		333	36-200726		332
36-164318	FE1-G431	714	36-195947		74	36-199372		854	36-199914		611	36-200740		171
36-164332	FE1-G433	511	36-195978		73	36-199372		855	36-199921		227	36-200740		182
36-164332	FE1-G433	536	36-195978		75	36-199389		599	36-199921		229	36-200740		218
36-164332	FE1-G433	537	36-195985		73	36-199389		854	36-199938		474	36-200764		198
36-165599	FE1-G559	433	36-195992		73	36-199419		605	36-199938		475	36-200764		557
36-166640	FE1-G664	433	36-195992		74	36-199426		605	36-199945		707	36-200764		689
36-166640	FE1-G664	434	36-196029		73	36-199433		605	36-199952		474	36-200788		198
36-171835	FE1-H183	397	36-196029		74	36-199488		489	36-199969		325	36-200788		557
36-171835	FE1-H183	398	36-196036		73	36-199488		555	36-199976		484	36-200788		689
36-171859	FE1-H185	397	36-196036		74	36-199488		623	36-199983		707	36-200795		198
36-171859	FE1-H185	398	36-196036		75	36-199488		624	36-199990		707	36-200795		557
36-171859	FE1-H185	400	36-196043		17	36-199532		647	36-200009		279	36-200795		689
36-171873	FE1-H187	397	36-196043		73	36-199549		647	36-200016		227	36-200818		433
36-171873	FE1-H187	398	36-196043		74	36-199556		672	36-200016		228	36-200818		434
36-171873	FE1-H187	400	36-196043		75	36-199556		673	36-200016		229	36-200825		638
36-171897	FE1-H189	397	36-196050		73	36-199556		834	36-200023		233	36-200825		844
36-171897	FE1-H189	398	36-196050		75	36-199556		835	36-200023		234	36-200849		660
36-171897	FE1-H189	400	36-196067		74	36-199556		836	36-200030		233	36-200856		360
36-171910	FE1-H191	567	36-196067		75	36-199563		834	36-200030		234	36-200863		360
36-171910	FE1-H191	568	36-196098		7	36-199563		836	36-200047		697	36-200870		685
36-171910	FE1-H191	569	36-196098		8	36-199570		665	36-200054		699	36-200887		370
36-171910	FE1-H191	570	36-196814		436	36-199594		663	36-200054		700	36-200887		371
36-171927	FE1-H192	567	36-196814		437	36-199594		664	36-200061		698	36-200894		372
36-171927	FE1-H192	568	36-196814		452	36-199594		674	36-200078		482	36-200900		372
36-171927	FE1-H192	569	36-197484	FE1-G207	152	36-199594		800	36-200078		483	36-200917		471
36-171927	FE1-H192	570	36-197491	FE1-G203	152	36-199594		801	36-200085		699	36-200917		472
36-171958	FE1-H195	277	36-197507		196	36-199594		804	36-200085		700	36-200917		473
36-171989	FE1-H198	396	36-197507		211	36-199594		806	36-200085		704	36-200924		461
36-171989	FE1-H198	418	36-197620		295	36-199594		814	36-200092		333	36-200931		464
36-171989	FE1-H198	431	36-197620		297	36-199600		663	36-200108	FE1-H190	657	36-200931		465
36-172061	FE1-H206	384	36-197620		299	36-199600		664	36-200108	FE1-H190	658	36-200948		686
36-172078	FE1-H207	384	36-197941		493	36-199600		802	36-200108	FE1-H190	783	36-200955		171
36-172078	FE1-H207	385	36-197941		494	36-199600		852	36-200146		707	36-20		



# New order number – Old order number

New	Old	Page	New	Old	Page	New	Old	Page	New	Old	Page	New	Old	Page
36-201068		232	36-201747		332	36-207275		45	36-213450		325	36-215744		688
36-201075		762	36-201761		764	36-207275		46	36-213450		326	36-215751		688
36-201082		759	36-201761		765	36-207275		48	36-213467		325	36-215768		688
36-201082		762	36-201785		614	36-207275		49	36-213474		325	36-215775		688
36-201099		762	36-201792		246	36-207275		50	36-213474		326	36-215782		688
36-201105		763	36-201792		247	36-208913		219	36-213542		484	36-215898		333
36-201112		261	36-201808		247	36-209590		512	36-213559		484	36-215911		468
36-201112		263	36-201815		292	36-209644		240	36-213566		484	36-215959		463
36-201112		265	36-201815		293	36-209682		503	36-213672		519	36-215966		381
36-201129		261	36-201846		239	36-209682		505	36-213931		659	36-215966		382
36-201129		269	36-201853		433	36-209682		506	36-213931		779	36-216093		381
36-201136		263	36-201860		659	36-209705		323	36-213962		659	36-216109		381
36-201136		265	36-201877		466	36-209705		544	36-213962		779	36-216116		381
36-201136		266	36-201877		467	36-209705		545	36-214334		238	36-216123		382
36-201143		292	36-201884		637	36-209705		546	36-214334		239	36-216130		332
36-201150		292	36-201884		638	36-209705		552	36-214334		877	36-216147		462
36-201150		293	36-201884		843	36-209705		553	36-214426		573	36-216147		676
36-201174		292	36-201884		844	36-209705		746	36-214440		386	36-216154		462
36-201174		293	36-201884		845	36-209705		748	36-214457		377	36-216154		677
36-201181		299	36-201907		635	36-209705		755	36-214457		378	36-216161		462
36-201204		295	36-201914		659	36-209712		804	36-214464		377	36-216178		368
36-201204		297	36-201938		659	36-209712		805	36-214464		378	36-216192		554
36-201211		473	36-201945	FE1-F452	532	36-209712		810	36-214471		377	36-216215		368
36-201228		476	36-201945	FE1-F452	533	36-209712		814	36-214471		378	36-216222		368
36-201228		477	36-201945	FE1-F452	534	36-209736		498	36-214501		268	36-216239		461
36-201235		707	36-201945	FE1-F452	535	36-209736		499	36-214518		268	36-216246		600
36-201242		686	36-202126		432	36-209736		500	36-214525		698	36-216260		461
36-201259		682	36-202133		531	36-209743		503	36-214532		698	36-216260		464
36-201266		295	36-202133		739	36-209743		505	36-214549		268	36-216284		488
36-201266		297	36-202140		183	36-209743		506	36-214556		698	36-216291		488
36-201266		299	36-202140		551	36-210213		519	36-214563		698	36-216307		488
36-201280		295	36-202140		739	36-210312		518	36-214570		698	36-216321		488
36-201280		297	36-202164		208	36-210312		519	36-214594		378	36-216338		246
36-201327		294	36-202164		556	36-210329		518	36-214792		759	36-216345		246
36-201334		294	36-202171		556	36-210350		507	36-214792		762	36-216369		483
36-201341		292	36-202201		556	36-211074		498	36-214808		465	36-216376		482
36-201341		293	36-202249		201	36-211074		499	36-214815		335	36-216376		483
36-201341		294	36-202249		202	36-211074		500	36-214839		462	36-216468		331
36-201358		71	36-202287		674	36-211272		572	36-214853		482	36-216581		182
36-201365		73	36-202287		855	36-211272		573	36-214853		483	36-216581		218
36-201365		74	36-202287		856	36-211340		795	36-214860		326	36-216604		182
36-201365		75	36-202287		877	36-211340		870	36-214884		330	36-216604		184
36-201372		73	36-202676		701	36-211340		872	36-214891		372	36-216604		219
36-201372		74	36-202690	FE1-G323	767	36-211371		206	36-214907		372	36-216611		182
36-201372		786	36-202751	FE1-G099	565	36-211371		248	36-214907		373	36-216635		182
36-201372		789	36-202799	FE1-F948	430	36-211401		576	36-214914		373	36-216635		184
36-201372		790	36-202843		236	36-211593		608	36-214921		372	36-216642		182
36-201372		795	36-202850		434	36-211968		197	36-214921		373	36-216659		182
36-201372		819	36-202867	FE1-H219	385	36-212484		196	36-214938		368	36-216659		184
36-201389		612	36-202867	FE1-H219	386	36-212484		197	36-214945		327	36-216666		184
36-201396		229	36-202874	FE1-H220	386	36-212491		197	36-214952		327	36-216673		184
36-201402		244	36-202911		577	36-212514		194	36-214990		378	36-216680		184
36-201402		246	36-202928		572	36-212514		195	36-215003		380	36-216697		184
36-201419		473	36-202928		573	36-212514		196	36-215010		222	36-216703		706
36-201426		474	36-202935		605	36-212514		556	36-215027		380	36-216710		706
36-201433		473	36-203109		843	36-212538		195	36-215034		465	36-216727		706
36-201440		605	36-203109		844	36-212545		196	36-215041		465	36-216741		380
36-201457		238	36-203109		845	36-212545		579	36-215058		512	36-216758		380
36-201457		239	36-203123		843	36-212552		195	36-215058		540	36-216765		380
36-201464		372	36-203123		844	36-212552		210	36-215065		231	36-216789		381
36-201471		463	36-203130		645	36-212552		579	36-215096		330	36-216796		380
36-201488		686	36-203130		778	36-212569		194	36-215102		377	36-216802		380
36-201495		607	36-203130		844	36-212569		196	36-215119		377	36-216819		380
36-201501		245	36-203130		845	36-212583		476	36-215119		378	36-216833		381
36-201501		246	36-203147		66	36-212583		606	36-215126		380	36-216901		209
36-201518		239	36-203147		68	36-212590		482	36-215133		487	36-216901		211
36-201525		244	36-203154		66	36-212590		483	36-215140		382	36-216901		565
36-201525		246	36-203154		68	36-212606		462	36-215171		488	36-217069		234
36-201532		238	36-203161		66	36-212613		38	36-215188		326	36-217076		235
36-201549		239	36-203178		66	36-212613		46	36-215195		184	36-217083		234
36-201556		466	36-203178		68	36-212613		50	36-215201		482	36-217083		235
36-201563		233	36-203185		66	36-212620		46	36-215201		483	36-217205		607
36-201563		359	36-203192		66	36-212620		50	36-215218		472	36-217205		608
36-201570		239	36-203192		68	36-212637		206	36-215218		473	36-217212		608
36-201587		245	36-203208		66	36-212705		370	36-215249		183	36-217229		476
36-201587		246	36-203208		68	36-212705		371	36-215249		187	36-217229		606
36-201594		245	36-203215		66	36-212712		370	36-215256		183	36-217236		476
36-201594		246	36-203215		68	36-212712		371	36-215256		187	36-217236		606
36-201600		245	36-203239		233	36-212712		335	36-215270		171	36-217328		326
36-201600		246	36-203239		234	36-213016		615	36-215270		182	36-217335		326
36-201617		437	36-203246		233	36-213023		615	36-215287		490	36-217366		476
36-201624		238	36-203246		234	36-213023		616	36-215300		182	36-217366		606
36-201624		239	36-203253		234	36-213030		615	36-215324		333	36-217373		476
36-201624		877	36-203260	FE1-F911	260	36-213030		616	36-215331		573	36-217373		606
36-201631		370	36-203260	FE1-F911	261	36-213177		469	36-215348		267	36-217397		333
36-201631		371	36-203277	FE1-F913	260	36-213184		469	36-215348		269	36-217403		333
36-201648		244	36-203277	FE1-F913	261	36-213191		469	36-215386		237	36-217410		334
36-201648		246	36-203277	FE1-F913	263	36-213207		459	36-215393		237	36-217427		334
36-201655		238	36-203284		611	36-213207		460	36-215423		237	36-217434		333
36-201655		239	36-203284		612	36-213207								



# New order number – Old order number

New	Old	Page	New	Old	Page	New	Old	Page	New	Old	Page	New	Old	Page
36-217571		248	36-221165		222	36-226177		387	36-234967		617	37-000820		274
36-217571		359	36-222209		206	36-226252		785	36-234981		820	37-000820		275
36-217571		577	36-222209		207	36-226252		813	36-234981		821	37-129392	FE1-C939	383
36-217939		240	36-222209		243	36-226764		639	36-234981		849	37-129408	FE1-C940	383
36-218080		761	36-222209		578	36-226924		137	36-235209		425	37-129491	FE1-C949	388
36-218080		762	36-222216		206	36-226924		140	36-235551		353	37-129491	FE1-C949	389
36-218080		770	36-222223		213	36-226931		408	36-235568		353	37-129491	FE1-C949	398
36-218097		757	36-222223		214	36-226931		409	36-235568		354	37-130275	FE1-D027	517
36-218110		465	36-222223		581	36-226931		413	36-236541		617	37-130275	FE1-D027	734
36-218127		770	36-222223		582	36-226993		388	36-236909		386	37-130282	FE1-D028	517
36-218165		762	36-222285		206	36-226993		389	36-237067		341	37-130282	FE1-D028	518
36-218165		770	36-222285		243	36-227136		388	36-237067		354	37-130282	FE1-D028	734
36-218219		760	36-222292		219	36-227136		389	36-237265		662	37-131197	FE1-D119	17
36-218219		761	36-222377		521	36-227167		427	36-237265		776	37-131302	FE1-D130	61
36-218226		468	36-222384		520	36-227167		428	36-237265		793	37-131302	FE1-D130	64
36-218295		762	36-222445		605	36-227174		388	36-237463		686	37-131302	FE1-D130	826
36-218301		762	36-223046		464	36-227174		389	36-237791		686	37-131302	FE1-D130	828
36-218318		765	36-223053		377	36-227174		390	36-237821		279	37-131302	FE1-D130	830
36-218547		518	36-223053		378	36-227181		388	36-237845		279	37-131302	FE1-D130	832
36-218547		519	36-223060		377	36-227181		390	36-237852		279	37-131326	FE1-D132	786
36-218547		520	36-223060		378	36-227181		402	36-237876		338	37-131326	FE1-D132	788
36-218554		698	36-224043		427	36-227181		431	36-237883		338	37-131333	FE1-D133	16
36-218585		2	36-224043		428	36-227211		419	36-237890		338	37-131333	FE1-D133	786
36-218585		3	36-224067		316	36-227228		410	36-237906		338	37-131333	FE1-D133	789
36-218776		519	36-224067		317	36-227228		411	36-237999		791	37-131333	FE1-D133	857
36-218776		520	36-224067		498	36-227235		409	36-237999		793	37-131364	FE1-D136	29
36-218783		519	36-224067		499	36-227235		410	36-239023		559	37-131371	FE1-D137	29
36-218783		520	36-224067		501	36-227235		411	36-239030		559	37-131371	FE1-D137	33
36-218790		519	36-224067		718	36-227402		565	36-239740		568	37-131371	FE1-D137	671
36-218806		518	36-224067		719	36-227402		566	36-239740		569	37-131371	FE1-D137	826
36-218806		519	36-224067		721	36-227402		567	36-239764		570	37-131371	FE1-D137	828
36-218806		520	36-224098		182	36-227433		482	36-239764		577	37-131371	FE1-D137	830
36-218813		518	36-224098		219	36-227440		482	36-239771		689	37-131371	FE1-D137	831
36-218813		519	36-225378		359	36-227464		79	36-239849		115	37-131371	FE1-D137	832
36-218820		518	36-225859		141	36-227464		80	36-239849		121	37-131371	FE1-D137	833
36-218820		519	36-225866		137	36-227464		81	36-240388		72	37-131388	FE1-D138	29
36-218820		520	36-225873		407	36-227464		84	36-240487		72	37-131388	FE1-D138	33
36-218844		772	36-225873		408	36-227488		59	36-241095		22	37-131388	FE1-D138	61
36-218950		573	36-225873		412	36-227488		88	36-241101		18	37-131388	FE1-D138	62
36-218967		572	36-225880		407	36-227488		89	36-241101		19	37-131388	FE1-D138	64
36-218967		573	36-225880		408	36-227495		861	36-241118		22	37-131388	FE1-D138	671
36-219001		468	36-225880		412	36-227495		862	36-241118		23	37-131388	FE1-D138	826
36-219018		468	36-225880		413	36-229697		140	36-241125		800	37-131388	FE1-D138	827
36-219025		468	36-225880		414	36-229705		482	36-241125		801	37-131388	FE1-D138	828
36-219056		377	36-225897		407	36-230150		156	36-241125		802	37-131388	FE1-D138	830
36-219056		378	36-225897		412	36-230242		337	36-241132		801	37-131388	FE1-D138	831
36-219063		377	36-225927		391	36-230242		353	36-241132		802	37-131388	FE1-D138	832
36-219063		378	36-225927		392	36-230259		337	36-241132		852	37-131388	FE1-D138	833
36-219162		231	36-225927		415	36-230259		353	36-241149		800	37-131395	FE1-D139	61
36-219179		231	36-225927		416	36-230600		380	36-241149		801	37-131395	FE1-D139	64
36-219193		377	36-225958		410	36-230778		329	36-241149		852	37-131395	FE1-D139	671
36-219193		378	36-225958		411	36-230778		330	36-241156		800	37-131395	FE1-D139	826
36-219209		377	36-225965		59	36-231430		247	36-241163		801	37-131395	FE1-D139	827
36-219209		378	36-225965		88	36-231591		455	36-241163		802	37-131395	FE1-D139	828
36-219230		487	36-225965		89	36-232406		607	36-241170		688	37-131401	FE1-D140	638
36-219247		487	36-225972		825	36-232406		608	36-241170		689	37-131401	FE1-D140	642
36-219254		487	36-225989		77	36-232796		705	36-241187		688	37-131401	FE1-D140	845
36-219261		512	36-225989		781	36-232932		682	36-241194		689	37-131418	FE1-D141	638
36-219261		540	36-225989		782	36-232949		682	36-241460		157	37-131418	FE1-D141	642
36-219278		540	36-225989		840	36-233175		71	36-241477		157	37-131418	FE1-D141	845
36-219285		490	36-225989		841	36-233250		116	36-241484		157	37-131425	FE1-D142	635
36-219292		757	36-225989		842	36-233274		353	36-241491		18	37-131425	FE1-D142	646
36-219322		464	36-225996		407	36-233274		354	36-241491		22	37-131425	FE1-D142	653
36-219339		380	36-225996		412	36-233281		341	36-241507		18	37-131425	FE1-D142	660
36-219346		222	36-225996		413	36-233281		354	36-241514		19	37-131425	FE1-D142	662
36-219377		685	36-225996		414	36-233540		341	36-241514		22	37-131425	FE1-D142	775
36-219421		685	36-226009		407	36-233540		354	36-241514		23	37-131425	FE1-D142	776
36-219452		682	36-226009		412	36-233564		72	36-241521		800	37-131425	FE1-D142	790
36-219476		462	36-226009		414	36-233571		15	36-241521		801	37-131425	FE1-D142	791
36-219476		463	36-226016		427	36-233571		847	36-241521		802	37-131425	FE1-D142	793
36-219506		233	36-226030		393	36-233588		15	36-241545		801	37-131425	FE1-D142	818
36-219506		359	36-226030		395	36-233588		16	36-241545		804	37-131425	FE1-D142	842
36-219513		764	36-226030		403	36-233625		152	36-241545		814	37-131425	FE1-D142	843
36-219513		765	36-226030		404	36-233649		152	36-241583		782	37-131425	FE1-D142	844
36-219520		765	36-226030		405	36-233663		157	36-241583		801	37-131425	FE1-D142	870
36-219544		466	36-226030		415	36-233694		854	36-241583		802	37-131432	FE1-D143	635
36-219544		467	36-226030		416	36-233779		403	36-241583		806	37-131432	FE1-D143	662
36-219636		291	36-226054		409	36-233779		415	36-241583		814	37-131432	FE1-D143	774
36-219643		291	36-226054		410	36-233779		416	36-241590		782	37-131432	FE1-D143	776
36-219650		512	36-226054		411	36-233779		418	36-241590		806	37-131432	FE1-D143	790
36-219650		540	36-226054		426	36-233793		674	36-241590		814	37-131432	FE1-D143	791
36-219667		577	36-226054		429	36-233861		676	36-242986	199021	168	37-131432	FE1-D143	870
36-219681		574	36-226061		426	36-233861		677	36-242986	199021	190	37-131449	FE1-D144	61
36-219681		575	36-226061		427	36-233892		329	36-300037		244	37-131449	FE1-D144	62
36-219711		574	36-226078		387	36-233892		330	36-300037		245	37-131449	FE1-D144	64
36-219735		575	36-226085		785	36-233908		428	36-300044		244	37-131449	FE1-D144	671



# New order number – Old order number

New	Old	Page	New	Old	Page	New	Old	Page	New	Old	Page	New	Old	Page
37-133030	FE1-D303	870	37-147839	FE1-E783	38	37-154585	FE1-F458	549	37-161309	FE1-G130	96	37-171841	FE1-H184	400
37-133030	FE1-D303	872	37-147839	FE1-E783	40	37-154585	FE1-F458	550	37-161309	FE1-G130	97	37-171865	FE1-H186	397
37-133498	FE1-D349	795	37-147839	FE1-E783	41	37-154585	FE1-F458	551	37-161309	FE1-G130	122	37-171865	FE1-H186	400
37-133498	FE1-D349	799	37-147839	FE1-E783	44	37-154585	FE1-F458	743	37-161309	FE1-G130	125	37-171889	FE1-H188	398
37-133498	FE1-D349	809	37-147839	FE1-E783	45	37-154585	FE1-F458	749	37-161309	FE1-G130	127	37-171889	FE1-H188	400
37-133627	FE1-D362	383	37-147839	FE1-E783	46	37-154585	FE1-F458	751	37-161781	FE1-G178	553	37-171933	FE1-H193	567
37-133719	FE1-D371	391	37-147839	FE1-E783	48	37-154585	FE1-F458	753	37-161781	FE1-G178	755	37-171933	FE1-H193	568
37-133719	FE1-D371	393	37-147839	FE1-E783	49	37-154592	FE1-F459	538	37-161798	FE1-G179	553	37-171933	FE1-H193	569
37-133719	FE1-D371	396	37-147846	FE1-E784	37	37-154592	FE1-F459	548	37-161798	FE1-G179	554	37-171933	FE1-H193	570
37-133719	FE1-D371	403	37-147846	FE1-E784	38	37-154592	FE1-F459	549	37-161798	FE1-G179	755	37-171940	FE1-H194	202
37-133719	FE1-D371	404	37-147846	FE1-E784	40	37-154592	FE1-F459	550	37-161804	FE1-G180	553	37-171940	FE1-H194	567
37-133719	FE1-D371	405	37-147846	FE1-E784	41	37-154592	FE1-F459	551	37-161804	FE1-G180	554	37-171940	FE1-H194	568
37-133726	FE1-D372	391	37-147846	FE1-E784	45	37-154592	FE1-F459	749	37-161804	FE1-G180	755	37-171940	FE1-H194	569
37-133726	FE1-D372	392	37-147846	FE1-E784	46	37-154592	FE1-F459	751	37-161859	FE1-G185	145	37-171940	FE1-H194	570
37-133726	FE1-D372	393	37-147846	FE1-E784	48	37-154592	FE1-F459	752	37-161866	FE1-G186	146	37-171964	FE1-H196	277
37-133726	FE1-D372	404	37-147846	FE1-E784	49	37-154592	FE1-F459	753	37-161880	FE1-G188	144	37-171971	FE1-H197	277
37-133726	FE1-D372	405	37-147921	FE1-E792	37	37-154608	FE1-F460	538	37-161897	FE1-G189	144	37-171995	FE1-H199	431
37-133733	FE1-D373	391	37-147921	FE1-E792	40	37-154608	FE1-F460	549	37-161903	FE1-G190	144	37-172008	FE1-H200	431
37-133733	FE1-D373	393	37-147921	FE1-E792	44	37-154608	FE1-F460	551	37-161910	FE1-G191	454	37-172015	FE1-H201	384
37-133733	FE1-D373	396	37-147921	FE1-E792	45	37-154608	FE1-F460	743	37-161927	FE1-G192	454	37-172015	FE1-H201	385
37-133733	FE1-D373	403	37-147921	FE1-E792	48	37-154608	FE1-F460	749	37-161941	FE1-G194	453	37-172022	FE1-H202	384
37-133740	FE1-D374	391	37-147921	FE1-E792	49	37-154608	FE1-F460	751	37-161972	FE1-G197	453	37-172022	FE1-H202	386
37-133740	FE1-D374	392	37-147938	FE1-E793	37	37-154608	FE1-F460	753	37-161972	FE1-G197	454	37-172039	FE1-H203	384
37-133740	FE1-D374	393	37-147938	FE1-E793	40	37-154615	FE1-F461	538	37-162023	FE1-G202	453	37-172039	FE1-H203	386
37-133740	FE1-D374	403	37-147938	FE1-E793	45	37-154615	FE1-F461	549	37-162627	FE1-G262	517	37-172046	FE1-H204	384
37-133740	FE1-D374	404	37-147938	FE1-E793	46	37-154615	FE1-F461	551	37-162627	FE1-G262	734	37-172046	FE1-H204	385
37-133740	FE1-D374	405	37-147938	FE1-E793	48	37-154622	FE1-F462	538	37-162627	FE1-G262	735	37-172053	FE1-H205	384
37-133757	FE1-D375	663	37-147938	FE1-E793	49	37-154622	FE1-F462	547	37-162917	FE1-G291	272	37-172053	FE1-H205	385
37-133757	FE1-D375	665	37-147945	FE1-E794	37	37-154622	FE1-F462	550	37-162917	FE1-G291	273	37-172107	FE1-H210	384
37-133757	FE1-D375	782	37-147945	FE1-E794	38	37-154622	FE1-F462	551	37-162924	FE1-G292	272	37-172107	FE1-H210	385
37-133757	FE1-D375	795	37-147945	FE1-E794	40	37-154622	FE1-F462	753	37-162931	FE1-G293	282	37-172114	FE1-H211	384
37-133757	FE1-D375	799	37-147945	FE1-E794	43	37-154639	FE1-F463	538	37-162948	FE1-G294	282	37-172114	FE1-H211	385
37-133757	FE1-D375	802	37-147945	FE1-E794	45	37-154639	FE1-F463	547	37-162948	FE1-G294	283	37-172121	FE1-H212	384
37-133757	FE1-D375	805	37-147945	FE1-E794	46	37-154639	FE1-F463	553	37-163075	FE1-G307	818	37-172121	FE1-H212	385
37-133757	FE1-D375	806	37-147945	FE1-E794	46	37-154639	FE1-F463	744	37-163433	FE1-G343	547	37-172121	FE1-H212	386
37-133757	FE1-D375	810	37-147945	FE1-E794	49	37-154639	FE1-F463	753	37-163433	FE1-G343	550	37-172138	FE1-H213	384
37-133757	FE1-D375	814	37-147952	FE1-E795	37	37-154738	FE1-F473	606	37-163433	FE1-G343	752	37-172138	FE1-H213	386
37-133955	FE1-D395	517	37-147952	FE1-E795	40	37-154738	FE1-F473	607	37-163433	FE1-G343	753	37-172145	FE1-H214	385
37-133955	FE1-D395	518	37-147952	FE1-E795	41	37-154738	FE1-F473	607	37-163488	FE1-G348	538	37-172145	FE1-H214	385
37-133955	FE1-D395	734	37-147952	FE1-E795	43	37-154752	FE1-F475	607	37-163488	FE1-G348	547	37-172220	FE1-H222	562
37-133955	FE1-D395	735	37-147952	FE1-E795	45	37-155131	FE1-F513	818	37-163488	FE1-G348	551	37-172251	FE1-H225	562
37-134051	FE1-D405	277	37-147952	FE1-E795	46	37-155155	FE1-F515	653	37-163488	FE1-G348	551	37-172251	FE1-H225	564
37-134051	FE1-D405	631	37-147952	FE1-E795	49	37-155155	FE1-F515	775	37-163495	FE1-G349	547	37-172268	FE1-H226	563
37-134051	FE1-D405	853	37-147952	FE1-E795	50	37-155155	FE1-F515	790	37-163495	FE1-G349	551	37-172268	FE1-H226	563
37-134129	FE1-D412	645	37-147969	FE1-E796	37	37-155155	FE1-F515	870	37-163495	FE1-G349	553	37-172299	FE1-H229	397
37-134129	FE1-D412	653	37-147969	FE1-E796	38	37-159108	FE1-F910	272	37-163495	FE1-G349	744	37-172299	FE1-H229	400
37-134129	FE1-D412	660	37-147969	FE1-E796	40	37-159108	FE1-F910	273	37-163495	FE1-G349	753	37-172305	FE1-H230	397
37-134129	FE1-D412	776	37-147969	FE1-E796	41	37-160654	FE1-G065	656	37-163495	FE1-G349	753	37-172312	FE1-H231	398
37-134129	FE1-D412	793	37-147969	FE1-E796	43	37-160654	FE1-G065	657	37-163549	FE1-G354	317	37-172329	FE1-H232	398
37-134211	FE1-D421	653	37-147969	FE1-E796	45	37-160654	FE1-G065	658	37-163549	FE1-G354	318	37-172336	FE1-H233	397
37-134211	FE1-D421	660	37-147969	FE1-E796	46	37-160654	FE1-G065	658	37-163549	FE1-G354	319	37-172343	FE1-H234	398
37-134211	FE1-D421	662	37-147969	FE1-E796	49	37-160654	FE1-G065	670	37-163549	FE1-G354	503	37-172343	FE1-H234	398
37-134211	FE1-D421	786	37-147969	FE1-E796	49	37-160654	FE1-G065	783	37-163549	FE1-G354	504	37-172350	FE1-H235	397
37-134211	FE1-D421	791	37-148041	FE1-E804	267	37-160654	FE1-G065	846	37-163549	FE1-G354	504	37-172367	FE1-H236	398
37-134211	FE1-D421	818	37-148041	FE1-E804	269	37-160678	FE1-G067	656	37-163549	FE1-G354	505	37-172367	FE1-H236	398
37-134211	FE1-D421	819	37-148058	FE1-E805	268	37-160678	FE1-G067	656	37-163549	FE1-G354	506	37-172374	FE1-H237	398
37-134211	FE1-D421	857	37-148058	FE1-E805	269	37-160678	FE1-G067	783	37-163549	FE1-G354	507	37-173425	FE1-H342	396
37-134228	FE1-D422	786	37-148102	FE1-E810	674	37-160678	FE1-G067	846	37-163549	FE1-G354	507	37-174026	FE1-H402	154
37-134228	FE1-D422	789	37-148102	FE1-E810	779	37-160692	FE1-G069	639	37-163549	FE1-G354	508	37-174033	FE1-H403	154
37-134228	FE1-D422	819	37-148102	FE1-E810	780	37-160692	FE1-G069	643	37-163549	FE1-G354	508	37-206307		206
37-134228	FE1-D422	857	37-148102	FE1-E810	799	37-160692	FE1-G069	656	37-163556	FE1-G355	318	37-206307		576
37-134327	FE1-D432	277	37-148119	FE1-E811	779	37-160692	FE1-G069	657	37-163556	FE1-G355	319	37-209674		503
37-134327	FE1-D432	631	37-148119	FE1-E811	780	37-160692	FE1-G069	657	37-163556	FE1-G355	503	37-209896		505
37-134327	FE1-D432	853	37-148126	FE1-E812	795	37-160692	FE1-G069	846	37-163556	FE1-G355	504	37-209896		507
37-134440	FE1-D444	830	37-148140	FE1-E814	674	37-160692	FE1-G069	847	37-163556	FE1-G355	504	37-210304		508
37-134440	FE1-D444	832	37-148140	FE1-E814	799	37-161019	FE1-G101	198	37-163556	FE1-G355	505	37-229177		282
37-134457	FE1-D445	277	37-148140	FE1-E814	810	37-161019	FE1-G101	199	37-163556	FE1-G355	506	37-229177		283
37-134457	FE1-D445	631	37-148140	FE1-E814	855	37-161019	FE1-G101	200	37-163556	FE1-G355	507	37-230180		437
37-134457	FE1-D445	853	37-148140	FE1-E814	856	37-161019	FE1-G101	200	37-163556	FE1-G355	508	37-231583		455
37-147662	FE1-E766	16	37-148164	FE1-E816	866	37-161033	FE1-G103	198	37-163556	FE1-G355	723	37-233051		199
37-147679	FE1-E767	16	37-148164	FE1-E816	867	37-161255	FE1-G125	123	37-163556	FE1-G355	724	37-235949		521
37-147686	FE1-E768	16	37-148164	FE1-E816	868	37-161255	FE1-G125	126	37-163556	FE1-G355	725	37-236052		521
37-147730	FE1-E773	18	37-148164	FE1-E816	869									



# New order number – Old order number

New	Old	Page	New	Old	Page	New	Old	Page	New	Old	Page	New	Old	Page
38-129216	FE1-C921	115	38-131097	FE1-D109	828	38-162534	FE1-G253	735	39-208064		441	39-209092		292
38-129216	FE1-C921	117	38-131097	FE1-D109	830	38-163036	FE1-G303	113	39-208071		438	39-209092		293
38-129223	FE1-C922	115	38-131097	FE1-D109	831	38-163036	FE1-G303	114	39-208071		439	39-209092		294
38-129223	FE1-C922	117	38-131097	FE1-D109	832	38-163050	FE1-G305	868	39-208088		438	39-209092		295
38-129223	FE1-C922	120	38-131097	FE1-D109	833	38-163067	FE1-G306	866	39-208088		438	39-209108		297
38-129223	FE1-C922	121	38-131158	FE1-D115	61	38-163067	FE1-G306	867	39-208088		439	39-209115		296
38-129230	FE1-C923	115	38-131158	FE1-D115	62	38-163425	FE1-G342	550	39-208088		862	39-209115		297
38-129230	FE1-C923	117	38-131158	FE1-D115	827	38-163425	FE1-G342	551	39-208132		443	39-209115		299
38-129230	FE1-C923	118	38-131158	FE1-D115	828	38-163425	FE1-G342	752	39-208132		448	39-209122		297
38-129230	FE1-C923	119	38-131172	FE1-D117	863	38-163425	FE1-G342	753	39-208149		440	39-209122		299
38-129230	FE1-C923	120	38-131172	FE1-D117	864	38-163456	FE1-G345	550	39-208149		441	39-209146		297
38-129230	FE1-C923	121	38-131219	FE1-D121	863	38-163456	FE1-G345	551	39-208163		442	39-209153		299
38-129285	FE1-C928	104	38-131219	FE1-D121	864	38-163456	FE1-G345	752	39-208163		443	39-209160		296
38-129292	FE1-C929	104	38-131233	FE1-D123	864	38-163456	FE1-G345	753	39-208187		442	39-209160		298
38-129322	FE1-C932	106	38-131233	FE1-D123	865	38-163470	FE1-G347	538	39-208187		443	39-209177		296
38-129889	FE1-C988	260	38-131240	FE1-D124	865	38-163470	FE1-G347	744	39-208194		442	39-209177		298
38-129889	FE1-C988	263	38-131257	FE1-D125	277	38-163500	FE1-G350	538	39-208194		443	39-209177		299
38-129889	FE1-C988	264	38-131257	FE1-D125	631	38-163500	FE1-G350	743	39-208200		442	39-209184		295
38-130182	FE1-D018	517	38-131257	FE1-D125	853	38-163524	FE1-G352	317	39-208200		443	39-209184		297
38-130182	FE1-D018	518	38-131264	FE1-D126	277	38-163524	FE1-G352	318	39-208224		442	39-209191		296
38-130182	FE1-D018	734	38-131264	FE1-D126	631	38-163524	FE1-G352	319	39-208224		443	39-209191		297
38-130182	FE1-D018	735	38-131264	FE1-D126	853	38-163524	FE1-G352	503	39-208231		439	39-209207		296
38-130199	FE1-D019	498	38-131271	FE1-D127	277	38-163524	FE1-G352	504	39-208231		440	39-209207		297
38-130199	FE1-D019	499	38-131271	FE1-D127	631	38-163524	FE1-G352	505	39-208231		441	39-209214		296
38-130199	FE1-D019	501	38-131271	FE1-D127	853	38-163524	FE1-G352	723	39-208248		441	39-209214		298
38-130199	FE1-D019	718	38-131349	FE1-D134	671	38-163524	FE1-G352	724	39-208248		442	39-209214		299
38-130199	FE1-D019	719	38-131349	FE1-D134	828	38-163531	FE1-G353	317	39-208248		443	39-209238		296
38-130205	FE1-D020	534	38-131349	FE1-D134	832	38-163531	FE1-G353	318	39-208255		442	39-209238		298
38-130205	FE1-D020	742	38-133190	FE1-D319	115	38-163531	FE1-G353	319	39-208255		443	39-209238		299
38-130236	FE1-D023	500	38-133190	FE1-D319	117	38-163531	FE1-G353	503	39-208255		443	39-209245		298
38-130236	FE1-D023	502	38-133985	FE1-D398	525	38-163531	FE1-G353	504	39-208262		448	39-209245		299
38-130236	FE1-D023	720	38-133985	FE1-D398	528	38-163531	FE1-G353	505	39-208279		439	39-209252		298
38-130243	FE1-D024	500	38-133985	FE1-D398	529	38-163531	FE1-G353	723	39-208279		440	39-209269		297
38-130243	FE1-D024	502	38-133985	FE1-D398	711	38-163531	FE1-G353	724	39-208279		441	39-209276		297
38-130243	FE1-D024	720	38-133985	FE1-D398	714	38-164231	FE1-G423	155	39-208286		439	39-209283		297
38-130243	FE1-D024	722	38-134401	FE1-D440	826	38-164248	FE1-G424	155	39-208286		440	39-209290		296
38-130298	FE1-D029	541	38-134401	FE1-D440	830	38-164255	FE1-G425	155	39-208286		441	39-209290		298
38-130298	FE1-D029	542	38-134401	FE1-D440	831	38-222412		538	39-208286		439	39-209290		299
38-130298	FE1-D029	543	38-134401	FE1-D440	833	38-222412		550	39-208293		440	39-209306		297
38-130298	FE1-D029	731	38-148194	FE1-E819	866	38-222412		551	39-208293		441	39-209306		299
38-130304	FE1-D030	532	38-148194	FE1-E819	867	38-222412		743	39-208316		440	39-209313		297
38-130304	FE1-D030	533	38-148194	FE1-E819	868	38-222412		752	39-208316		441	39-209320		300
38-130304	FE1-D030	534	38-148200	FE1-E820	866	38-222412		753	39-208330		443	39-209320		301
38-130304	FE1-D030	535	38-148200	FE1-E820	867	38-225819		321	39-208330		448	39-209337		300
38-130304	FE1-D030	728	38-148224	FE1-E822	869	38-225819		510	39-208347		444	39-209337		301
38-130304	FE1-D030	729	38-153914	FE1-F391	113	38-228599		153	39-208347		445	39-209344		301
38-130304	FE1-D030	742	38-154508	FE1-F450	183	38-232655		354	39-208347		446	39-209351		300
38-130304	FE1-D030	743	38-154508	FE1-F450	491	38-233654		157	39-208347		447	39-209351		301
38-130311	FE1-D031	533	38-154508	FE1-F450	492	38-233715		115	39-208361		445	39-209368		297
38-130311	FE1-D031	535	38-154515	FE1-F451	541	38-233715		116	39-208361		446	39-209375		296
38-130311	FE1-D031	729	38-154515	FE1-F451	542	38-233715		117	39-208361		859	39-209382		298
38-130311	FE1-D031	742	38-154515	FE1-F451	543	38-233715		119	39-208361		860	39-209399		298
38-130328	FE1-D032	532	38-154546	FE1-F454	548	38-233715		121	39-208378		447	39-209405		296
38-130328	FE1-D032	533	38-154546	FE1-F454	549	38-235801		521	39-208378		448	39-209405		298
38-130328	FE1-D032	728	38-154546	FE1-F454	749	38-235801		522	39-208378		860	39-209405		299
38-130342	FE1-D034	177	38-154546	FE1-F454	751	38-236198		121	39-208385		445	39-209412		296
38-130342	FE1-D034	178	38-154553	FE1-F455	538	38-236389		437	39-208385		446	39-209412		298
38-130342	FE1-D034	515	38-154553	FE1-F455	548	38-236655		353	39-208385		859	39-209429		296
38-130342	FE1-D034	516	38-154553	FE1-F455	549	38-240508		553	39-208385		860	39-209429		298
38-130342	FE1-D034	732	38-154553	FE1-F455	743	38-241536		17	39-208392		444	39-209429		299
38-130366	FE1-D036	493	38-154553	FE1-F455	749	38-241536		791	39-208392		445	39-209436		301
38-130366	FE1-D036	494	38-154553	FE1-F455	751	38-242205		671	39-208392		446	39-209443		300
38-130366	FE1-D036	496	38-154560	FE1-F456	547	39-202352		861	39-208392		859	39-209443		301
38-130366	FE1-D036	497	38-161063	FE1-G106	493	39-202352		862	39-208392		860	39-209467		298
38-130366	FE1-D036	526	38-161063	FE1-G106	494	39-202413		778	39-208408		444	39-209474		300
38-130366	FE1-D036	527	38-161063	FE1-G106	715	39-203359		438	39-208408		445	39-209474		301
38-130366	FE1-D036	528	38-161421	FE1-G142	512	39-203359		439	39-208408		446	39-209481		301
38-130366	FE1-D036	712	38-161421	FE1-G142	513	39-203359		440	39-208408		447	39-209498		296
38-130366	FE1-D036	713	38-161421	FE1-G142	514	39-203359		441	39-208408		859	39-209498		297
38-130366	FE1-D036	715	38-161421	FE1-G142	740	39-203359		862	39-208408		860	39-209504		292
38-130373	FE1-D037	181	38-161421	FE1-G142	741	39-203427		450	39-208897		447	39-209511		292
38-130373	FE1-D037	221	38-161438	FE1-G143	181	39-203489		449	39-208897		448	39-209528		292
38-130373	FE1-D037	526	38-161438	FE1-G143	526	39-203489		450	39-208897		860	39-209535		292
38-130373	FE1-D037	527	38-161438	FE1-G143	528	39-203700		450	39-208903		447	39-209542		301
38-130373	FE1-D037	528	38-161438	FE1-G143	712	39-203793		448	39-208903		448	39-209559		301
38-130373	FE1-D037	529	38-161834	FE1-G183	532	39-203793		449	39-208903		860	39-209566		300
38-130373	FE1-D037	712	38-161834	FE1-G183	537	39-203991		450	39-208965		292	39-209566		301
38-130373	FE1-D037	713	38-162350	FE1-G235	318	39-204196		448	39-208965		293	39-209573		300
38-130380	FE1-D038	495	38-162350	FE1-G235	506	39-204196		449	39-208965		294	39-209580		300
38-130380	FE1-D038	497	38-162350	FE1-G235	507	39-204264		448	39-208965		295	39-2101		

# New order number – Old order number



New	Old	Page	New	Old	Page	New	Old	Page	New	Old	Page	New	Old	Page
39-220899		859	44-110475	VA5-B047	429	46-111906	SN5-B190	17	46-180308		872	46-180988		110
39-220899		860	44-110482	VA5-B048	429	46-111906	SN5-B190	646	46-180315		661	46-180995		114
39-220943		213	44-110499	VA5-B049	429	46-111906	SN5-B190	653	46-180315		776	46-181008		110
39-220943		214	44-110505	VA5-B050	429	46-111906	SN5-B190	661	46-180315		792	46-181015		114
39-220943		254	44-111533	BL5-B153	434	46-111906	SN5-B190	775	46-180315		872	46-181022		109
39-220943		255	44-121167	BL5-C116	434	46-111906	SN5-B190	792	46-180322		792	46-181022		112
39-220943		582	44-124748	BL5-C474	363	46-111906	SN5-B190	871	46-180339		792	46-181039		109
39-220967		212	44-124748	BL5-C474	364	46-111920	SN5-B192	315	46-180339		871	46-181039		112
39-220967		213	44-139872	BL5-D987	363	46-111920	SN5-B192	316	46-180346		792	46-181046		114
39-220967		253	44-139889	BL5-D988	363	46-111920	SN5-B192	493	46-180346		871	46-181053		113
39-220967		254	44-140779	VA5-E077	429	46-111920	SN5-B192	494	46-180353		792	46-181060		113
39-220967		580	44-140786	VA5-E078	429	46-111920	SN5-B192	497	46-180360		775	46-181077		110
39-220967		581	44-143657	VA5-E365	420	46-111920	SN5-B192	715	46-180377		775	46-181084		110
39-222671		470	44-143657	VA5-E365	422	46-111920	SN5-B192	716	46-180384		661	46-181091		114
39-222855		212	44-143664	VA5-E366	420	46-111937	SN5-B193	662	46-180384		775	46-181107		145
39-222855		213	44-143664	VA5-E366	422	46-111937	SN5-B193	777	46-180384		776	46-181107		162
39-222855		252	44-146108	BL5-E610	433	46-111937	SN5-B193	794	46-180391		776	46-181114		145
39-222855		253	44-156251	BL5-F625	433	46-111944	SN5-B194	662	46-180407		777	46-181121		145
39-222855		580	44-156251	BL5-F625	436	46-111944	SN5-B194	777	46-180407		794	46-181138		146
39-222855		581	44-156268	BL5-F626	436	46-111944	SN5-B194	794	46-180414		777	46-181145		146
39-228260		214	44-165062	BL5-G506	433	46-111951	SN5-B195	178	46-180414		794	46-181152		148
39-228260		215	44-165062	BL5-G506	436	46-111951	SN5-B195	320	46-180421		777	46-181169		148
39-228260		255	44-181666	VA5-E281	420	46-111951	SN5-B195	513	46-180421		794	46-181176		148
39-228260		256	44-181666	VA5-E281	422	46-111951	SN5-B195	514	46-180438		777	46-181183		148
39-228260		583	44-181680	VA5-E282	420	46-111951	SN5-B195	515	46-180438		778	46-181190		145
39-229069		439	44-181680	VA5-E282	422	46-111951	SN5-B195	516	46-180438		794	46-181206		145
39-229069		440	44-191177	BL5-A775	363	46-111951	SN5-B195	733	46-180452		453	46-181220		154
39-229069		441	44-191825		152	46-111951	SN5-B195	734	46-180452		454	46-181237		156
39-229069		444	44-191832		152	46-111951	SN5-B195	740	46-180469		455	46-181251		157
39-229069		445	44-192075	VA5-H536	429	46-111951	SN5-B195	741	46-180469		457	46-181268		157
39-229069		446	44-192082	VA5-H537	429	46-111975	SN5-B197	636	46-180469		459	46-181275		158
39-229069		447	44-218669		363	46-111975	SN5-B197	642	46-180476		456	46-181282		274
39-229069		859	44-218676		363	46-111999	SN5-B199	842	46-180476		458	46-181299		274
39-229069		860	44-219215		152	46-112002	SN5-B200	635	46-180483		96	46-181299		275
39-230027		444	44-219222		152	46-112002	SN5-B200	818	46-180483		98	46-181305		275
39-230027		445	44-232726		364	46-112019	SN5-B201	635	46-180490		96	46-181312		275
39-230126		213	44-232733		364	46-112019	SN5-B201	818	46-180490		98	46-181329		274
39-230126		214	44-236595		364	46-112255	SN5-B225	790	46-180506		96	46-181336		270
39-230126		254	44-236601		364	46-112255	SN5-B225	795	46-180506		98	46-181336		271
39-230126		255	44-236618		364	46-112279	SN5-B227	787	46-180513		96	46-181343		270
39-230126		582	44-236625		364	46-112279	SN5-B227	858	46-180513		98	46-181343		271
39-230133		214	45-218644		363	46-113047	SN5-B304	108	46-180520		100	46-181350		272
39-230133		254	45-218651		363	46-113047	SN5-B304	111	46-180537		99	46-181367		272
39-230133		255	45-240690		363	46-113054	SN5-B305	108	46-180544		124	46-181374		270
39-230133		582	45-240706		363	46-113054	SN5-B305	111	46-180544		161	46-181374		271
39-231321		446	45-240713		363	46-113221	SN5-B322	787	46-180551		124	46-181381		272
39-231819		439	45-240720		363	46-113221	SN5-B322	858	46-180551		161	46-181398		427
39-231819		440	45-241272		364	46-180001		116	46-180568		124	46-181404		387
39-231819		441	45-241734		364	46-180001		118	46-180575		126	46-181701		390
40-076614	KLF-7661	406	46-000033		156	46-180001		120	46-180582		126	46-181725		390
40-076614	KLF-7661	420	46-000033		157	46-180001		121	46-180599		126	46-181732		390
40-076614	KLF-7661	422	46-000040		12	46-180018		116	46-180605		124	46-181749		390
40-076614	KLF-7661	451	46-000064		10	46-180018		118	46-180612		124	46-181756		431
40-076621	KLF-7662	406	46-000071		10	46-180018		120	46-180629		126	46-181763		403
40-076621	KLF-7662	420	46-000095		12	46-180018		121	46-180636		126	46-181770		403
40-076621	KLF-7662	422	46-000101		105	46-180018		160	46-180643		128	46-181787		403
40-076621	KLF-7662	451	46-000118		105	46-180025		116	46-180650		129	46-181794		403
40-076638	KLF-7663	422	46-000132		107	46-180025		118	46-180667		130	46-181800		392
40-076676	KLF-7667	420	46-000156		107	46-180025		120	46-180674		130	46-181800		404
40-076683	KLF-7668	420	46-000163		105	46-180025		122	46-180681		130	46-181800		405
40-116402	KLF-B640	406	46-000187		633	46-180032		116	46-180698		124	46-181817		392
40-116419	KLF-B641	406	46-000194		633	46-180049		116	46-180698		128	46-181817		404
40-118673	KLF-B867	433	46-000200		648	46-180056		121	46-180698		129	46-181817		405
40-148342	KLF-E834	433	46-000217		648	46-180070		117	46-180711		124	46-181824		394
40-148342	KLF-E834	436	46-000224		648	46-180087		117	46-180711		161	46-181831		394
40-148359	KLF-E835	434	46-000262		648	46-180094		122	46-180728		124	46-181862		421
40-221601		154	46-000262		649	46-180100		117	46-180728		161	46-181879		421
40-221618		154	46-000279		664	46-180117		116	46-180735		127	46-182043		432
40-231990		142	46-000279		675	46-180117		119	46-180742		127	46-182050		432
40-231990		143	46-000286		664	46-180117		122	46-180759		399	46-182067		423
40-232003		142	46-000293		666	46-180117		160	46-180759		424	46-182074		423
40-232003		143	46-000354		666	46-180124		117	46-180759		425	46-182081		406
40-240732		363	46-000361		819	46-180131		116	46-180766		399	46-182098		385
40-240732		364	46-000378		819	46-180131		118	46-180766		424	46-182104		385
41-173435	BL5-H343	432	46-000439		832	46-180148		17	46-180766		425	46-182111		386
44-042295	VA5-4229	429	46-000446		832	46-180155		17	46-180773		401	46-182128		317
44-042301	VA5-4230	429	46-000453		832	46-180162		17	46-180773		402	46-182128		318
44-045357	VA5-4535	429	46-000491		834	46-180179		17	46-180780		401	46-182128		319
44-045821	VA5-4582	429	46-000507		834	46-180186		17	46-180780		402	46-182128		504
44-046972	VA5-4697	429	46-000514		834	46-180193		775	46-180797		105	46-182128		506
44-047023	VA5-4702	429	46-000613		118	46-180193		777	46-180803		105	46-182128		723
44-051518	VA5-5151	429	46-000613		120	46-180193		792	46-180810		107	46-182128		724
44-051525	VA5-5152	429	46-000637		386	46-180193		794	46-180827		107	46-182135		318
44-069483	BL3-6948	345	46-000682		192	46-180209		775	46-180834		105	46-182135		319
44-069506	BL3-6950	345	46-000736		108	46-180209		777	46-180841		14			



# New order number – Old order number

New	Old	Page	New	Old	Page	New	Old	Page	New	Old	Page	New	Old	Page
46-182166		318	46-182906		12	46-184214		800	46-188564		42	46-189004		320
46-182166		319	46-182920		6	46-184269		815	46-188564		51	46-189004		513
46-182166		504	46-182920		7	46-184290		815	46-188571		42	46-189004		514
46-182166		505	46-182937		4	46-184313		815	46-188571		51	46-189004		515
46-182166		506	46-182968		39	46-184320		810	46-188588		39	46-189004		733
46-182166		723	46-182975		39	46-184337		810	46-188588		47	46-189004		734
46-182166		724	46-182982		39	46-184337		811	46-188588		92	46-189011		320
46-182173		319	46-182999		39	46-184344		811	46-188595		39	46-189011		515
46-182173		504	46-183002		39	46-184351		783	46-188595		48	46-189011		733
46-182173		505	46-183019		39	46-184368		783	46-188595		92	46-189011		734
46-182173		506	46-183026		42	46-184375		783	46-188601		42	46-189028		517
46-182173		723	46-183033		42	46-184382		852	46-188601		51	46-189028		735
46-182180		319	46-183040		42	46-184399		837	46-188601		639	46-189035		321
46-182180		507	46-183057		42	46-184405		835	46-188601		640	46-189035		517
46-182197		507	46-183064		42	46-184405		838	46-188618		42	46-189035		735
46-182197		725	46-183071		42	46-184412		835	46-188618		51	46-189035		736
46-182197		726	46-183088		20	46-184412		838	46-188618		640	46-189042		517
46-182203		559	46-183095		20	46-184412		875	46-188670		44	46-189059		321
46-182203		560	46-183101		20	46-184429		836	46-188687		44	46-189059		517
46-182203		561	46-183118		20	46-184429		839	46-188694		827	46-189059		735
46-182210		560	46-183125		20	46-184436		837	46-188700		827	46-189059		736
46-182210		561	46-183132		24	46-184436		839	46-188717		827	46-189066		31
46-182210		562	46-183156		24	46-184436		840	46-188755		166	46-189073		31
46-182227		560	46-183163		24	46-184443		835	46-188755		509	46-189080		31
46-182227		561	46-183170		24	46-184443		837	46-188755		727	46-189080		32
46-182234		560	46-183187		24	46-184443		838	46-188762		509	46-189097		31
46-182234		561	46-183194		31	46-184443		839	46-188762		727	46-189097		32
46-182241		560	46-183200		31	46-184443		840	46-188779		509	46-189103		31
46-182258		560	46-183200		32	46-184450		848	46-188779		727	46-189110		31
46-182258		561	46-183217		31	46-184467		848	46-188786		522	46-189110		32
46-182265		699	46-183224		31	46-184474		797	46-188786		737	46-189127		34
46-182265		700	46-183224		32	46-184481		803	46-188786		738	46-189127		35
46-182265		701	46-183231		34	46-184498		803	46-188793		522	46-189134		34
46-182272		699	46-183248		34	46-184504		805	46-188793		737	46-189134		35
46-182272		700	46-183248		35	46-184504		806	46-188793		738	46-189141		34
46-182272		701	46-183255		34	46-184511		805	46-188823		523	46-189141		35
46-182289		758	46-183255		35	46-184511		807	46-188823		738	46-189158		35
46-182289		759	46-183262		35	46-187901		855	46-188830		523	46-189165		35
46-182296		758	46-183279		31	46-187918		599	46-188830		738	46-189172		35
46-182296		759	46-183279		32	46-187925		276	46-188847		523	46-189172		36
46-182302		646	46-183286		31	46-187932		276	46-188847		738	46-189189		31
46-182319		646	46-183286		32	46-187949		803	46-188854		523	46-189189		32
46-182326		646	46-183293		35	46-187956		803	46-188854		738	46-189196		31
46-182333		646	46-183293		36	46-187963		805	46-188861		315	46-189196		32
46-182340		648	46-183309		35	46-187963		806	46-188861		316	46-189202		32
46-182357		648	46-183309		36	46-187970		805	46-188861		493	46-189219		35
46-182364		648	46-183316		35	46-187970		806	46-188861		494	46-189219		36
46-182371		648	46-183323		53	46-187987		155	46-188861		496	46-189226		35
46-182388		639	46-183323		54	46-187994		646	46-188861		715	46-189226		36
46-182388		640	46-183323		92	46-188007		653	46-188861		716	46-189233		35
46-182395		639	46-183330		53	46-188014		653	46-188861		717	46-189233		36
46-182395		640	46-183330		55	46-188021		653	46-188878		495	46-189257		32
46-182401		42	46-183347		55	46-188069		803	46-188878		717	46-189257		36
46-182418		42	46-183354		55	46-188076		803	46-188878		718	46-189264		32
46-182425		644	46-183361		32	46-188083		72	46-188885		315	46-189264		36
46-182425		645	46-183361		36	46-188083		94	46-188885		316	46-189301		194
46-182432		644	46-183378		39	46-188090		72	46-188885		494	46-189318		208
46-182432		645	46-183385		39	46-188106		152	46-188885		495	46-189325		208
46-182449		643	46-183408		21	46-188120		240	46-188885		715	46-189332		201
46-182456		643	46-183422		21	46-188120		241	46-188885		716	46-189332		202
46-182470		642	46-183439		25	46-188137		240	46-188892		501	46-189332		203
46-182487		633	46-183446		25	46-188137		241	46-188892		721	46-189349		202
46-182494		633	46-183446		807	46-188144		519	46-188908		317	46-189349		203
46-182500		634	46-183521		53	46-188144		520	46-188908		319	46-189356		209
46-182517		634	46-183521		55	46-188144		736	46-188908		502	46-189356		210
46-182524		661	46-183521		92	46-188151		519	46-188908		722	46-189363		199
46-182531		661	46-183736		846	46-188151		520	46-188915		501	46-189370		199
46-182548		662	46-183767		803	46-188151		736	46-188922		502	46-189387		216
46-182555		662	46-183774		803	46-188168		240	46-188939		316	46-189387		366
46-182562		663	46-183781		811	46-188168		241	46-188939		317	46-189400		218
46-182562		675	46-183798		811	46-188175		240	46-188939		499	46-189424		220
46-182579		664	46-183804		815	46-188175		241	46-188939		500	46-189424		221
46-182586		666	46-183811		815	46-188427		109	46-188939		719	46-189431		220
46-182593		666	46-183927		846	46-188427		111	46-188939		720	46-189431		221
46-182609		657	46-183927		847	46-188427		113	46-188946		316	46-189448		150
46-182616		657	46-183934		846	46-188434		11	46-188946		317	46-189455		150
46-182623		656	46-183934		847	46-188441		11	46-188946		498	46-189462		150
46-182630		656	46-183941		829	46-188465		39	46-188946		500	46-189479		151
46-182647		656	46-183941		834	46-188465		47	46-188946		718	46-189493		155
46-182654		672	46-183958		829	46-188465		92	46-188946		720	46-189509		155
46-182661		672	46-183965		829	46-188472		39	46-188953		170	46-189516		156
46-182678		658	46-183972		829	46-188472		47	46-188953		501	46-189523		154
46-182685		672	46-183972		834	46-188472		92	46-188953		721	46-189530		154
46-182685		673	46-183989		829	46-188489		39	46-188953		722	46-189547		153
46-182692		658	46-183989		834	46-188489		47	46-188960		316	46-189554		153
46-182708		659	46-183996		829	46-188489		92	46-188960		317	46-189554		163
46-182715		659	46-184009		856	46-188496		39	46-188960		499	46-189578		75
46-182739		5	46-184016		856	46-188496		47	46-188960		500	46-189592		74
46-182739		7	46-184023		820	46-188502		39	46-188960		719	46-189608		74
46-182753		6	46-184030		820	46-188502		47	46-188960		720	46-189608		75
46-182753		7	46-184047		796	46-188519		39	46-188977		170	46-189615		76
46-1827														

# New order number – Old order number



New	Old	Page	New	Old	Page	New	Old	Page	New	Old	Page	New	Old	Page
46-189776		58	46-190604		539	46-192509		227	46-194237		554	46-206961		478
46-189783		57	46-190604		552	46-192516		239	46-194237		755	46-206985		532
46-189790		57	46-190604		744	46-192523		239	46-194244		553	46-206985		739
46-189806		81	46-190604		753	46-192530		239	46-194244		554	46-207005		532
46-189813		81	46-190611		539	46-192547		284	46-194244		755	46-207005		739
46-189820		44	46-190611		552	46-192554		284	46-194275		563	46-207036		577
46-189837		44	46-190611		744	46-192561		285	46-194282		563	46-207043		557
46-189844		67	46-190611		754	46-192578		285	46-194299		563	46-207050		617
46-189851		67	46-190628		539	46-192608		283	46-194305		563	46-207067		617
46-189868		784	46-190628		552	46-192615		283	46-194305		564	46-207074		617
46-189868		812	46-190628		744	46-192646		378	46-194312		566	46-207081		617
46-189868		851	46-190628		754	46-192653		379	46-194312		567	46-207098		675
46-189868		852	46-190635		568	46-192660		378	46-194329		566	46-207104		675
46-189875		67	46-190642		568	46-192677		379	46-194329		567	46-207135		676
46-189882		67	46-190659		568	46-192721		542	46-194336		278	46-207159		677
46-189899		68	46-190673		598	46-192721		543	46-194343		278	46-207166		689
46-189905		68	46-190697		600	46-192738		542	46-194350		756	46-207173		708
46-189912		68	46-190703		763	46-192738		543	46-194367		756	46-207180		708
46-189929		68	46-190710		763	46-192745		544	46-194374		628	46-207197		783
46-189936		68	46-190727		759	46-192745		545	46-194381		628	46-222916		224
46-189943		784	46-190734		759	46-192745		746	46-194398		629	46-223500		10
46-189950		785	46-190741		764	46-192745		748	46-194404		629	46-223609		101
46-189950		813	46-190765		843	46-192752		544	46-194534		20	46-223609		102
46-189967		785	46-190772		845	46-192752		546	46-194541		20	46-223661		131
46-189967		813	46-190789		842	46-192752		747	46-194558		20	46-223661		132
46-189981		788	46-190796		845	46-192752		748	46-194565		20	46-223678		132
46-189981		858	46-190802		845	46-192769		547	46-194572		24	46-226617		132
46-190000		788	46-190819		844	46-192769		749	46-194589		24	46-228864		224
46-190000		858	46-190833		818	46-192776		547	46-194596		25	46-228888		310
46-190017		788	46-190840		844	46-192776		749	46-194596		25	46-228888		311
46-190017		858	46-190871		139	46-192783		544	46-194640		24	46-229779		250
46-190024		788	46-190888		139	46-192783		545	46-194657		21	46-229779		251
46-190024		858	46-190888		141	46-192783		746	46-194664		21	46-229786		250
46-190062		790	46-190895		139	46-192783		748	46-194671		25	46-229786		251
46-190062		795	46-190901		139	46-192783		749	46-194688		25	46-229793		133
46-190079		789	46-190918		139	46-192790		547	46-194688		807	46-229793		134
46-190086		789	46-190925		139	46-192806		534	46-194695		403	46-229809		133
46-190093		781	46-190925		141	46-192806		742	46-194749		654	46-229809		134
46-190109		781	46-190932		140	46-192813		534	46-194756		654	46-229816		276
46-190116		268	46-190949		139	46-192813		742	46-194763		654	46-229823		276
46-190123		268	46-190949		140	46-192820		535	46-194770		654	46-229830		310
46-190130		325	46-190956		139	46-192820		743	46-194770		655	46-229830		311
46-190130		326	46-190956		140	46-192837		536	46-194787		810	46-230904		797
46-190154		327	46-190963		245	46-192837		743	46-194794		810	46-230904		871
46-190178		327	46-190987		245	46-192851		321	46-194794		811	46-230904		873
46-190208		328	46-191014		245	46-192851		510	46-194800		811	46-230911		797
46-190208		329	46-191021		245	46-192851		728	46-194817		811	46-230911		873
46-190215		331	46-191045		246	46-192868		510	46-194824		811	46-232823		217
46-190215		332	46-191052		246	46-192875		556	46-194855		796	46-232823		615
46-190246		331	46-191465		153	46-192875		557	46-194855		871	46-234360		224
46-190246		332	46-191465		163	46-192882		556	46-194855		873	46-234377		224
46-190284		338	46-191984	BTS-7514	706	46-192899		556	46-194862		797	46-234384		310
46-190291		338	46-191991	SE5-C785	309	46-192899		557	46-194862		871	46-234391		310
46-190307		373	46-192134		865	46-193285		790	46-194862		873	46-237156		431
46-190307		382	46-192134		866	46-193575	SE5-C630	429	46-194879		797	46-237538		101
46-190314		373	46-192141		867	46-193605		589	46-194909		797	46-237538		102
46-190321		373	46-192141		868	46-193605		590	46-194909		871	46-237545		101
46-190338		382	46-192141		869	46-193612		592	46-194909		873	46-237545		102
46-190345		381	46-192158		867	46-193803		598	46-194916		798	46-237552		101
46-190383		384	46-192158		868	46-193810		71	46-194916		873	46-237552		102
46-190413		417	46-192158		869	46-193827		71	46-194961		797	46-237569		101
46-190420		417	46-192165		854	46-193834		71	46-194978		799	46-237569		103
46-190420		418	46-192172		854	46-193841		71	46-194985		799	46-237576		132
46-190437		418	46-192189		841	46-193858		632	46-194985		800	46-237583		133
46-190444		418	46-192189		842	46-193865		632	46-194992		800	46-237583		134
46-190475		395	46-192196		63	46-193872		278	46-195104		146	46-237927		614
46-190475		396	46-192196		93	46-193889		278	46-195111		147	46-240194		852
46-190482		395	46-192202		63	46-193896		635	46-195128		146	46-240309		678
46-190482		397	46-192202		93	46-193902		391	46-195173		147	46-240309		701
46-190499		422	46-192219		63	46-193919		391	46-195180		147	47-080386	HE5-8038	336
46-190505		422	46-192219		93	46-193926		430	46-195197		15	47-080416	HE5-8041	18
46-190529		472	46-192226		63	46-193940		291	46-195197		16	47-080416	HE5-8041	74
46-190536		548	46-192226		93	46-193957		291	46-195203		15	47-080416	HE5-8041	75
46-190536		550	46-192233		63	46-193964		433	46-195203		16	47-080416	HE5-8041	647
46-190536		750	46-192240		63	46-194008		548	46-198297		310	47-080416	HE5-8041	776
46-190536		752	46-192257		63	46-194008		550	46-198297		311	47-080416	HE5-8041	793
46-190543		548	46-192264		63	46-194008		750	46-200402		175	47-080416	HE5-8041	819
46-190543		550	46-192271		65	46-194008		752	46-206657		198	47-080478	HE5-8047	74
46-190543		750	46-192288		65	46-194022		508	46-206671		216	47-080478	HE5-8047	75
46-190543		752	46-192295		65	46-194039		508	46-206688		216	47-080478	HE5-8047	647
46-190550		548	46-192301		65	46-194046		346	46-206695		216	47-080713	HE5-8071	165
46-190550		550	46-192318		65	46-194060		548	46-206718		236	47-080713	HE5-8071	167
46-190550		750	46-192325		65	46-194060		550	46-206732		236	47-080713	HE5-8071	178
46-190550		752	46-192332		65	46-194060		750	46-206749		204	47-080713	HE5-8071	320
46-190567		548	46-192349		65	46-194060		752	46-206763		291	47-080713	HE5-8071	513
46-190567		550	46-192356		60	46-194077		548	46-206770		272	47-080713	HE5-8071	514
46-190567		750	46-192363		60	46-194077		550	46-206770		273	47-080713	HE5-8071	515
46-190567		752	46-192363		89	46-194077		750	46-206787		272	47-080713	HE5-8071	516
46-190574		539	46-192370		61	46-194077		752	46-206787		273	47-080713	HE5-8071	540
46-190574														



# New order number – Old order number

New	Old	Page	New	Old	Page	New	Old	Page	New	Old	Page	New	Old	Page
47-083004	SS0-8300	381	47-124806	HE5-C480	834	47-146914	HE5-E691	658	47-229969		808	48-088602	GM5-8860	404
47-083011	SS0-8301	365	47-124813	HE5-C481	109	47-146914	HE5-E691	846	47-229969		809	48-088602	GM5-8860	406
47-086401	HE5-8640	365	47-124813	HE5-C481	112	47-146914	HE5-E691	847	47-229976		27	48-088657	GM5-8865	336
47-086937	HE5-8693	63	47-124813	HE5-C481	113	47-155770	HE5-F577	250	47-229976		28	48-088688	GM5-8868	63
47-086937	HE5-8693	66	47-124813	HE5-C481	114	47-155770	HE5-F577	251	47-229976		650	48-088688	GM5-8868	66
47-086937	HE5-8693	827	47-124844	HE5-C484	781	47-155770	HE5-F577	279	47-229976		667	48-088688	GM5-8868	828
47-086937	HE5-8693	829	47-124844	HE5-C484	785	47-158276	HE5-F827	703	47-229976		669	48-088688	GM5-8868	830
47-086937	HE5-8693	832	47-124844	HE5-C484	788	47-158283	HE5-F828	773	47-229976		808	48-088688	GM5-8868	832
47-086937	HE5-8693	834	47-124844	HE5-C484	790	47-158283	HE5-F828	774	47-229976		809	48-088688	GM5-8868	834
47-087392	HE5-8739	324	47-124844	HE5-C484	795	47-158283	HE5-F828	804	47-231108		385	48-088749	GM5-8874	63
47-087392	HE5-8739	325	47-124844	HE5-C484	813	47-158283	HE5-F828	853	47-231108		402	48-088749	GM5-8874	66
47-087484	HE5-8748	169	47-124844	HE5-C484	858	47-158993	HE5-F899	192	47-231207		510	48-088749	GM5-8874	93
47-087484	HE5-8748	499	47-124844	HE5-C484	874	47-158993	HE5-F899	230	47-231207		727	48-088749	GM5-8874	672
47-087484	HE5-8748	719	47-124851	HE5-C485	18	47-158993	HE5-F899	359	47-232952		276	48-088749	GM5-8874	827
47-087484	HE5-8748	720	47-124851	HE5-C485	647	47-164499	HE5-G449	12	47-233942		604	48-088749	GM5-8874	830
47-087569	HE5-8756	560	47-124851	HE5-C485	654	47-164499	HE5-G449	240	47-235106		578	48-088749	GM5-8874	832
47-087569	HE5-8756	561	47-124851	HE5-C485	776	47-164499	HE5-G449	241	47-237308		614	48-088749	GM5-8874	834
47-087569	HE5-8756	562	47-124851	HE5-C485	793	47-164499	HE5-G449	242	47-238602		604	48-088756	GM5-8875	699
47-087750	HE5-8775	603	47-124851	HE5-C485	819	47-164499	HE5-G449	520	47-239180		604	48-088756	GM5-8875	700
47-100763	HE5-A076	142	47-124851	HE5-C485	820	47-164499	HE5-G449	736	47-239197		604	48-088756	GM5-8875	701
47-100770	HE5-A077	392	47-124851	HE5-C485	872	47-164499	HE5-G449	737	47-242043		268	48-088763	GM5-8876	406
47-100770	HE5-A077	394	47-124851	HE5-C485	875	47-165403	HE5-G540	677	47-242104		565	48-088763	GM5-8876	421
47-100770	HE5-A077	395	47-126848	HE5-C684	116	47-165854	HE5-G585	335	47-242135		565	48-088763	GM5-8876	451
47-100770	HE5-A077	397	47-126848	HE5-C684	119	47-167254	HE5-G725	321	47-242142		565	48-100724	GM5-A072	4
47-100770	HE5-A077	404	47-126848	HE5-C684	120	47-167254	HE5-G725	517	48-080347	GM5-8034	109	48-100724	GM5-A072	6
47-100770	HE5-A077	405	47-126848	HE5-C684	122	47-167254	HE5-G725	541	48-080347	GM5-8034	112	48-100724	GM5-A072	7
47-100817	HE5-A081	202	47-126848	HE5-C684	160	47-167254	HE5-G725	735	48-080347	GM5-8034	113	48-100724	GM5-A072	11
47-100817	HE5-A081	203	47-126916	HE5-C691	454	47-167254	HE5-G725	736	48-080347	GM5-8034	114	48-101288	GM5-A128	679
47-100817	HE5-A081	568	47-127708	HE5-C770	21	47-167254	HE5-G725	745	48-080408	GM5-8040	110	48-103398	GM5-A339	679
47-100817	HE5-A081	569	47-127708	HE5-C770	25	47-167490	HE5-G749	268	48-080422	GM5-8042	18	48-103398	GM5-A339	680
47-100817	HE5-A081	570	47-127708	HE5-C770	26	47-167490	HE5-G749	302	48-080422	GM5-8042	74	48-104555	GM5-A455	142
47-100817	HE5-A081	571	47-127708	HE5-C770	633	47-167490	HE5-G749	368	48-080422	GM5-8042	75	48-104692	GM5-A469	142
47-101623	HE5-A162	472	47-127708	HE5-C770	634	47-167551	HE5-G755	367	48-080422	GM5-8042	647	48-104739	GM5-A473	156
47-101791	HE5-A179	679	47-127708	HE5-C770	649	47-167551	HE5-G755	686	48-080422	GM5-8042	776	48-104739	GM5-A473	157
47-101791	HE5-A179	680	47-127708	HE5-C770	655	47-167551	HE5-G755	687	48-080422	GM5-8042	793	48-105958	GM5-A595	39
47-107632	HE5-A763	675	47-127708	HE5-C770	664	47-168053	HE5-G805	462	48-080422	GM5-8042	819	48-105958	GM5-A595	43
47-107632	HE5-A763	676	47-127708	HE5-C770	666	47-168091	HE5-G809	15	48-080453	GM5-8045	272	48-105958	GM5-A595	44
47-107991	HE5-A799	338	47-127708	HE5-C770	672	47-168091	HE5-G809	16	48-080460	GM5-8046	270	48-105958	GM5-A595	48
47-107991	HE5-A799	341	47-127708	HE5-C770	673	47-168091	HE5-G809	644	48-080460	GM5-8046	271	48-105958	GM5-A595	51
47-110267	HE5-B026	382	47-127708	HE5-C770	675	47-168091	HE5-G809	645	48-080484	GM5-8048	74	48-108041	GM5-A804	338
47-111165	HE5-B116	145	47-127708	HE5-C770	798	47-168091	HE5-G809	848	48-080484	GM5-8048	75	48-108041	GM5-A804	341
47-111165	HE5-B116	162	47-127708	HE5-C770	800	47-168091	HE5-G809	876	48-080484	GM5-8048	647	48-110297	GM5-B029	382
47-111264	HE5-B126	142	47-127708	HE5-C770	805	47-168299	HE5-G829	199	48-080569	S03-8056	781	48-115575	GM5-B557	592
47-114609	HE5-B460	592	47-127708	HE5-C770	807	47-169289	HE5-G928	39	48-080569	S03-8056	785	48-115575	GM5-B557	594
47-114609	HE5-B460	594	47-127708	HE5-C770	812	47-169289	HE5-G928	42	48-080569	S03-8056	788	48-115674	GM5-B567	109
47-116115	HE5-B611	432	47-127708	HE5-C770	815	47-169289	HE5-G928	44	48-080569	S03-8056	790	48-115674	GM5-B567	112
47-116573	HE5-B657	67	47-127708	HE5-C770	816	47-169289	HE5-G928	48	48-080569	S03-8056	795	48-115674	GM5-B567	113
47-116573	HE5-B657	68	47-127708	HE5-C770	835	47-169289	HE5-G928	51	48-080569	S03-8056	813	48-115676	GM5-B576	109
47-116573	HE5-B657	69	47-127708	HE5-C770	837	47-169289	HE5-G928	92	48-080569	S03-8056	859	48-115676	GM5-B576	112
47-116573	HE5-B657	94	47-127708	HE5-C770	838	47-169289	HE5-G928	640	48-080569	S03-8056	874	48-115676	GM5-B576	113
47-118478	HE5-B847	465	47-127708	HE5-C770	839	47-171329	HE5-H132	332	48-080651	GM5-8065	18	48-116077	GM5-B607	432
47-118768	HE5-B876	331	47-127708	HE5-C770	840	47-171725	HE5-H172	166	48-080651	GM5-8065	647	48-116541	GM5-B654	67
47-119215	HE5-B921	4	47-127708	HE5-C770	856	47-171725	HE5-H172	180	48-080651	GM5-8065	654	48-116541	GM5-B654	69
47-119215	HE5-B921	6	47-127708	HE5-C770	872	47-171725	HE5-H172	191	48-080651	GM5-8065	776	48-116541	GM5-B654	94
47-119215	HE5-B921	7	47-127708	HE5-C770	874	47-171725	HE5-H172	321	48-080651	GM5-8065	793	48-118804	GM5-B880	331
47-119215	HE5-B921	11	47-127708	HE5-C770	875	47-171725	HE5-H172	322	48-080651	GM5-8065	819	48-119542	GM5-B954	192
47-119444	HE5-B944	39	47-127708	HE5-C770	877	47-171725	HE5-H172	509	48-080651	GM5-8065	820	48-119542	GM5-B954	431
47-119444	HE5-B944	43	47-128347	HE5-C834	21	47-171725	HE5-H172	510	48-080651	GM5-8065	872	48-121262	GM5-C126	274
47-119444	HE5-B944	44	47-128347	HE5-C834	25	47-171725	HE5-H172	727	48-080651	GM5-8065	875	48-121262	GM5-C126	275
47-119444	HE5-B944	48	47-128347	HE5-C834	633	47-172401	HE5-H240	335	48-080736	GM5-8073	637	48-121262	GM5-C126	302
47-119444	HE5-B944	51	47-128347	HE5-C834	634	47-172586	HE5-H258	617	48-080736	GM5-8073	642	48-121262	GM5-C126	373
47-119536	HE5-B953	192	47-128347	HE5-C834	649	47-175976	HE5-H597	200	48-080736	GM5-8073	843	48-121262	GM5-C126	374
47-119536	HE5-B953	431	47-128347	HE5-C834	655	47-175976	HE5-H597	205	48-080750	GM5-8075	485	48-121262	GM5-C126	383
47-120471	HE5-C047	14	47-128347	HE5-C834	664	47-188044	HE5-H416	708	48-080767	GM5-8076	165	48-121262	GM5-C126	756
47-120471	HE5-C047	15	47-128347	HE5-C834	666	47-188044	HE5-H416	709	48-080767	GM5-8076	167	48-121262	GM5-C126	758
47-120471	HE5-C047	96	47-128347	HE5-C834	675	47-193680		339	48-080767	GM5-8076	178	48-121262	GM5-C126	759
47-120471	HE5-C047	98	47-128347	HE5-C834	798	47-196568		276	48-080767	GM5-8076	320	48-121262	GM5-C126	773
47-120471	HE5-C047	99	47-128347	HE5-C834	800	47-207233		101	48-080767	GM5-8076	513	48-121897	GM5-C189	598
47-120471	HE5-C047	100	47-128347	HE5-C834	805	47-207233		103	48-080767	GM5-8076	514	48-121897	GM5-C189	600
47-120471	HE5-C047	124	47-128347	HE5-C834	812	47-207233		132	48-080767	GM5-8076	516	48-123525	GM5-C352	679
47-120471	HE5-C047	127	47-128347	HE5-C834	815	47-217522		101	48-080767	GM5-8076	540	48-123525	GM5-C352	680
47-120471	HE5-C047	129	47-128347	HE5-C834	816	47-217522		103	48-080767	GM5-8076	733	48-123952	GM5-C395	148
47-120471	HE5-C047	130	47-128347	HE5-C834	872	47-217522		132	48-080767	GM5-8076</				



# New order number – Old order number

New	Old	Page	New	Old	Page	New	Old	Page	New	Old	Page	New	Old	Page
48-135238	GM5-D523	635	48-153720	GM5-F372	456	48-230032		27	49-196849		836			
48-135238	GM5-D523	649	48-153720	GM5-F372	457	48-230032		28	49-196849		837			
48-135238	GM5-D523	655	48-153720	GM5-F372	458	48-230049		27	49-196849		838			
48-135238	GM5-D523	664	48-153720	GM5-F372	459	48-230056		29	49-196849		839			
48-135238	GM5-D523	666	48-155830	GM5-F583	680	48-230056		27	49-196849		840			
48-135238	GM5-D523	675	48-156745	GM5-F674	804	48-230056		29	49-196849		853			
48-135238	GM5-D523	798	48-158176	GM5-F817	773	48-230056		650	49-196849		856			
48-135238	GM5-D523	800	48-158176	GM5-F817	774	48-230056		668	49-196849		872			
48-135238	GM5-D523	806	48-158176	GM5-F817	804	48-230056		669	49-196849		874			
48-135238	GM5-D523	812	48-158176	GM5-F817	853	48-230056		808	49-196849		875			
48-135238	GM5-D523	815	48-165815	GM5-G581	342	48-230056		809	49-207323		102			
48-135238	GM5-D523	816	48-165815	GM5-G581	472	48-230063		27	49-207323		103			
48-135238	GM5-D523	872	48-166560	GM5-G656	424	48-230063		29	49-207323		132			
48-135238	GM5-D523	874	48-166560	GM5-G656	451	48-230063		650	49-216042		595			
48-135245	GM5-D524	21	48-168229	GM5-G822	15	48-230063		668	49-216042		596			
48-135245	GM5-D524	25	48-168229	GM5-G822	16	48-230063		669	49-223873		599			
48-135245	GM5-D524	26	48-168229	GM5-G822	644	48-230063		808	49-223873		600			
48-135245	GM5-D524	633	48-168229	GM5-G822	645	48-230063		809	49-224658		101			
48-135245	GM5-D524	635	48-168229	GM5-G822	848	48-230834		102	49-224658		102			
48-135245	GM5-D524	649	48-168229	GM5-G822	876	48-230834		103	49-224658		103			
48-135245	GM5-D524	655	48-169301	GM5-G930	39	48-230834		133	49-224658		132			
48-135245	GM5-D524	664	48-169301	GM5-G930	43	48-230834		162	49-224658		133			
48-135245	GM5-D524	666	48-169301	GM5-G930	44	48-230971		385	49-224658		134			
48-135245	GM5-D524	673	48-169301	GM5-G930	48	48-230971		402	49-224658		162			
48-135245	GM5-D524	674	48-169301	GM5-G930	51	48-231848		28	49-231892		28			
48-135245	GM5-D524	675	48-169301	GM5-G930	92	48-231848		29	49-231892		29			
48-135245	GM5-D524	798	48-169301	GM5-G930	640	48-231848		650	49-231892		650			
48-135245	GM5-D524	800	48-169998	GM5-G999	158	48-231848		668	49-231892		668			
48-135245	GM5-D524	806	48-177580	GM5-H758	147	48-231848		669	49-231892		669			
48-135245	GM5-D524	807	48-177580	GM5-H758	163	48-231848		808	49-231892		808			
48-135245	GM5-D524	812	48-181440	GM5-H606	598	48-231954		76	49-231892		809			
48-135245	GM5-D524	815	48-191845		175	48-231954		77	49-234923		145			
48-135245	GM5-D524	816	48-195232		14	48-233132		456	49-237108		125			
48-135245	GM5-D524	835	48-195232		15	48-233132		457	49-237108		129			
48-135245	GM5-D524	837	48-195232		97	48-233132		458	49-237108		131			
48-135245	GM5-D524	838	48-195232		98	48-233132		459	49-237191		431			
48-135245	GM5-D524	839	48-195232		99	48-236775		595	49-237276		148			
48-135245	GM5-D524	840	48-195232		100	48-238212		614	50-174546	ACO-H454	122			
48-135245	GM5-D524	856	48-195232		125	48-238649		385	50-174546	ACO-H454	124			
48-135245	GM5-D524	872	48-195232		127	48-238946		102	50-174546	ACO-H454	129			
48-135245	GM5-D524	874	48-195232		129	48-238946		103	50-174546	ACO-H454	131			
48-135245	GM5-D524	875	48-195232		131	48-238946		133	53-001313	UK-KT-013	703			
48-135245	GM5-D524	877	48-197441		407	49-115604	GA5-B560	593	53-001436	UK-KT-014	703			
48-135344	GM5-D534	590	48-207287		101	49-115604	GA5-B560	594	53-001702	UK-KT-017	467			
48-135344	GM5-D534	591	48-207287		103	49-122046	GA5-C204	598	53-001702	UK-KT-017	468			
48-135344	GM5-D534	592	48-207287		132	49-122046	GA5-C204	600	53-001931	UK-KT-019	361			
48-135351	GM5-D535	590	48-213660		119	49-131543	GA5-D154	14	53-001931	UK-KT-019	362			
48-135351	GM5-D535	591	48-215855		109	49-131543	GA5-D154	15	53-002402	UK-KT-024	347			
48-135368	GM5-D536	591	48-215855		112	49-131543	GA5-D154	97	53-002549	UK-KT-025	480			
48-135498	GM5-D549	145	48-215909		22	49-131543	GA5-D154	98	53-005007	UK-KT-005	702			
48-135498	GM5-D549	162	48-215909		26	49-131543	GA5-D154	99	53-006011	UK-KT-006	702			
48-135887	GM5-D588	592	48-215909		649	49-131543	GA5-D154	100	53-007001	UK-KT-007	702			
48-135887	GM5-D588	593	48-215909		664	49-131543	GA5-D154	125	53-008008	UK-KT-008	690			
48-135887	GM5-D588	594	48-215909		666	49-131543	GA5-D154	127	53-011015	UK-KT-011	702			
48-135887	GM5-D588	595	48-215909		673	49-131543	GA5-D154	129	53-012012	UK-KT-012	703			
48-136013	GM5-D601	593	48-215909		674	49-131543	GA5-D154	131	53-230461	UK-KT-004	703			
48-136013	GM5-D601	594	48-215909		798	49-131543	GA5-D154	161		B46-2161	616			
48-136013	GM5-D601	595	48-215909		804	49-132380	GA5-D238	406		BE5-2648	208			
48-136648	GM5-D664	454	48-215909		816	49-132380	GA5-D238	421		VE3-06083	208			
48-136648	GM5-D664	455	48-215909		817	49-132380	GA5-D238	451		VE3-06084	208			
48-136723	GM5-D672	366	48-215909		853	49-135121	GA5-D512	116		VE3-4162	602			
48-136723	GM5-D672	539	48-215909		874	49-135121	GA5-D512	119		VE3-4163	602			
48-136723	GM5-D672	744	48-216036		595	49-135121	GA5-D512	120		XDE-7830	208			
48-136723	GM5-D672	754	48-216036		596	49-135121	GA5-D512	122		AFS-B724	760			
48-137539	GM5-D753	589	48-217170		101	49-135121	GA5-D512	160		AFS-B724	761			
48-138864	GM5-D886	76	48-217170		103	49-135169	GA5-D516	145						
48-138864	GM5-D886	77	48-217170		132	49-135169	GA5-D516	162						
48-139137	GM5-D913	783	48-217170		133	49-135817	GA5-D581	593						
48-139243	GM5-D924	8	48-217170		134	49-135817	GA5-D581	594						
48-139243	GM5-D924	9	48-217170		161	49-135817	GA5-D581	595						
48-139243	GM5-D924	10	48-217170		162	49-135985	GA5-D598	593						
48-139243	GM5-D924	12	48-218412		593	49-135985	GA5-D598	594						
48-141147	GM5-E114	399	48-221832		69	49-135985	GA5-D598	595						
48-141147	GM5-E114	401	48-221832		70	49-145489	GA5-E548	593						
48-141147	GM5-E114	402	48-221832		94	49-151282	GA5-F128	53						
48-141147	GM5-E114	425	48-222983		175	49-151282	GA5-F128	55						
48-141147	GM5-E114	450	48-223539		99	49-151282	GA5-F128	56						
48-141635	GM5-E163	156	48-223539		125	49-151282	GA5-F128	57						
48-141635	GM5-E163	157	48-223539		129	49-151282	GA5-F128	58						
48-145459	GM5-E545	593	48-223539		131	49-151282	GA5-F128	59						
48-145701	GM5-E570	99	48-223867		599	49-151282	GA5-F128	93						
48-145701	GM5-E570	124	48-223867		600	49-196849		21						
48-145701	GM5-E570	129	48-227018		97	49-196849		22						
48-145701	GM5-E570	131	48-227018		98	49-196849		25						
48-146142	GM5-E614	472	48-227018		125	49-196849		26						
48-146852	GM5-E685	639	48-227018		127	49-196849		633						
48-146852	GM5-E685	643	48-227018		129	49-196849		649						
48-146852	GM5-E685	656	48-227186		466	49-196849		655						
48-146852	GM5-E685	657	48-228299		678	49-196849		664						
48-146852	GM5-E685	658	48-228299		701	49-196849		666						
48-146852	GM5-E685	847	48-229012		101	49-196849		673						
48-147231	GM5-E723	53	48-229012		103	49-196849		675						
48-147231	GM5-E723	55	48-229012		132	49-196849		774						
48-147231	GM5-E723	56	48-229012		133	49-196849		798				</		



## New in the range 2014

Order-No.	Type	Order-No.	Type	Order-No.	Type	Order-No.	Type	Order-No.	Type
11-223900	B1	19-224503	B4	19-236001	B8	22-228611	B4	22-235893	B6-Sport
11-239734	B1	19-224527	B6-Sport	19-236087	B6-Sport	22-229038	B4	22-235916	B8
11-240457	B1	19-224541	B8	19-236100	B8	22-229045	B4	22-235923	B8
12-116935	B1	19-225234	B4	19-236155	B6-Sport	22-229113	B4	22-235954	B6-Sport
12-117291	B1	19-225272	B4	19-236186	B8	22-229120	B4	22-235961	B6-Sport
12-228454	B1	19-225289	B4	19-236223	B6-Sport	22-229342	B4	22-235985	B8
12-228461	B1	19-226323	B4	19-236254	B8	22-229366	B4	22-235992	B8
12-228478	B1	19-226330	B4	19-236285	B6-Sport	22-229373	B4	22-236043	B6-Sport
12-228485	B1	19-226392	B4	19-236315	B8	22-229380	B4	22-236067	B6-Sport
12-228492	B1	19-226491	B4	19-236513	B4	22-229397	B4	22-236074	B6-Sport
12-228508	B1	19-226705	B4	19-236681	B4	22-229427	B4	22-236098	B8
12-228515	B1	19-226736	B4	19-236971	B4	22-229434	B4	22-236135	B6-Sport
12-228522	B1	19-226743	B4	19-238784	B4	22-229458	B4	22-236142	B6-Sport
12-228539	B1	19-226750	B4	19-238791	B4	22-229465	B4	22-236166	B8
12-228546	B1	19-226798	B4	19-239828	B4	22-229502	B4	22-236173	B8
12-228553	B1	19-226859	B4	19-240848	B4	22-229519	B4	22-236203	B6-Sport
12-228560	B1	19-226866	B4	22-049223	B4	22-229564	B4	22-236210	B6-Sport
12-228638	B1	19-226880	B4	22-166661	B4	22-229571	B4	22-236234	B8
12-228645	B1	19-226897	B4	22-170217	B4	22-229656	B4	22-236241	B8
12-228652	B1	19-226903	B4	22-193377	B6-Sport	22-229663	B4	22-236265	B6-Sport
12-228669	B1	19-226910	B4	22-196019	B4-DMC	22-229670	B4	22-236272	B6-Sport
12-228676	B1	19-227054	B4	22-196651	B4	22-229687	B4	22-236296	B8
12-228683	B1	19-227085	B4	22-196668	B4	22-230522	B4	22-236302	B8
12-228690	B1	19-227566	B4	22-196873	B4	22-230539	B4	22-237491	B4
12-228713	B1	19-227573	B4	22-196880	B4	22-230652	B6-Sport	22-237507	B4
12-228720	B1	19-227627	B4	22-210692	B6-Sport	22-230676	B4	22-237514	B4
12-228744	B1	19-227634	B4	22-210739	B6-Sport	22-230683	B4	22-237521	B4
12-228751	B1	19-227641	B4	22-213860	B4	22-230867	B4	22-238245	B4
12-228768	B1	19-227696	B4	22-213877	B4	22-230874	B4	22-238252	B4
12-228775	B1	19-227740	B4	22-213983	B4	22-230935	B4	22-238269	B4
12-228782	B1	19-227771	B4	22-213990	B4	22-230942	B4	22-238276	B4
12-228799	B1	19-227801	B4	22-214065	B4	22-230959	B4	22-238818	B4
12-228805	B1	19-227832	B4	22-214300	B4	22-231116	B4	22-239075	B4
12-228812	B1	19-227856	B4	22-214317	B4	22-231123	B4	22-239099	B6-Sport
12-228829	B1	19-227863	B4	22-215796	B4	22-231130	B4	22-239105	B6-Sport
12-231409	B1	19-227870	B4	22-215802	B4	22-231147	B4	22-239129	B8
12-231607	B1	19-227887	B4	22-215819	B6-Sport	22-231369	B4	22-239143	B8
12-231614	B1	19-227894	B4	22-215826	B8	22-231376	B4	22-239594	B4
12-231621	B1	19-227900	B4	22-215833	B4	22-231444	B4	22-240125	B6-Sport
12-231638	B1	19-227917	B4	22-217653	B6-Sport	22-231925	B6-Sport	22-240583	B4
12-233939	B1	19-227924	B4	22-217660	B6-Sport	22-231932	B8	22-240590	B4
12-233960	B1	19-227931	B4	22-217684	B8	22-232045	B4	22-243034	B6-Sport
12-234059	B1	19-227948	B4	22-217691	B8	22-232052	B4	22-243041	B6-Sport
12-234073	B1	19-227955	B4	22-218254	B6-Sport	22-232090	B6-Sport	22-243058	B8
12-234080	B1	19-229096	B4	22-218278	B8	22-232106	B6-Sport	22-243065	B8
12-234097	B1	19-229355	B4	22-219589	B4	22-232120	B8	22-243201	B4
12-234103	B1	19-229409	B4	22-220554	B4	22-232137	B8	22-243218	B4
12-234110	B1	19-229416	B4	22-221407	B4	22-232229	B8	23-230668	B6-DTC
12-234127	B1	19-229447	B4	22-221414	B4	22-232236	B8	23-231153	B4-DTC
12-234134	B1	19-229492	B4	22-222046	B4	22-232410	B4	23-231160	B4-DTC
12-234141	B1	19-229522	B4	22-222084	B6-Sport	22-232427	B4	23-233324	B4-DTC
12-234158	B1	19-229539	B4	22-222107	B8	22-232465	B4	23-233331	B4-DTC
12-234165	B1	19-229584	B4	22-222152	B8	22-232472	B4	24-001113	B6-Sport
12-234172	B1	19-229614	B4	22-222169	B8	22-232496	B4	24-004596	B6-Sport
12-234189	B1	19-230221	B4	22-223395	B6-Sport	22-232502	B4	24-006309	B6-Sport
12-234196	B1	19-230238	B4	22-223401	B6-Sport	22-232526	B4	24-006514	B6-Sport
12-234295	B1	19-230542	B4	22-223425	B8	22-232533	B4	24-006521	B6-Sport
12-234318	B1	19-230559	B4	22-223432	B8	22-232618	B4	24-008341	MS
12-234325	B1	19-230573	B4	22-223470	B4	22-232625	B4	24-012577	B6-Sport
12-234332	B1	19-230887	B4	22-223975	B4	22-232809	B8	24-013291	B6-4600
12-234622	B1	19-230894	B4	22-224491	B4	22-232854	B6-Sport	24-016155	B6-4600
12-238026	B1	19-231389	B4	22-224514	B6-Sport	22-232861	B4	24-017756	B8
12-238033	B1	19-231457	B4	22-224538	B8	22-232908	B4	24-021777	B6-4600
12-238088	B1	19-232034	B4	22-224583	B4	22-232915	B4	24-022361	B6-4600
12-238095	B1	19-232065	B4	22-225214	B4	22-233677	B8	24-023139	MS
12-238149	B1	19-232157	B4	22-225221	B4	22-233707	B6-Sport	24-024785	B6-4600
12-242191	B1	19-232430	B4	22-225245	B4	22-233721	B6-Sport	24-024792	B6-4600
12-242733	B1	19-232485	B4	22-225252	B4	22-233745	B8	24-024877	MS
12-242740	B1	19-232515	B4	22-226372	B4	22-233752	B8	24-029032	B6-4600
12-243945	B1	19-232546	B4	22-226389	B4	22-234636	B4	24-057608	MS
12-243952	B1	19-232553	B4	22-226464	B4	22-234643	B4	24-062107	B8-5100
14-230615	B1-iRC	19-232638	B4	22-226471	B4	22-235039	B6-Sport	24-062466	B8-5100
19-183510	B4	19-232690	B4	22-226631	B6-Sport	22-235053	B6-Sport	24-064576	B8-5100
19-183534	B4	19-232812	B8	22-226648	B6-Sport	22-235336	B6-Sport	24-065276	B8-5100
19-196671	B4	19-232928	B4	22-226716	B4	22-235367	B6-Sport	24-065283	B8-5100
19-196893	B4	19-233734	B6-Sport	22-226723	B4	22-235428	B6-Sport	24-066464	B8-5100
19-213880	B4	19-233765	B8	22-226969	B4	22-235435	B6-Sport	24-067379	B8-5100
19-213910	B4	19-234656	B4	22-226976	B4	22-235459	B8	24-100144	B8-5100
19-214320	B4	19-235042	B6-Sport	22-226983	B4	22-235466	B8	24-107617	B6-4600
19-217451	B4	19-235219	B4	22-227065	B4	22-235527	B6-Sport	24-107624	B6-4600
19-218625	B4	19-235370	B6-Sport	22-227072	B4	22-235534	B6-Sport	24-109345	B6-4600
19-218632	B4	19-235448	B6-Sport	22-227553	B4	22-235565	B8	24-109369	B6-4600
19-218717	B4	19-235479	B8	22-227706	B4	22-235572	B8	24-122986	B8-5100
19-218724	B4	19-235486	B6-Sport	22-227713	B4	22-235626	B6-Sport	24-131582	B6-4600
19-218731	B4	19-235493	B6-Sport	22-227720	B4	22-235633	B6-Sport	24-131599	B6-4600
19-218748	B4	19-235509	B8	22-227737	B4	22-235657	B8	24-137430	B6-4600
19-219073	B4	19-235516	B8	22-227782	B4	22-235664	B8	24-151627	B8-5100
19-219080	B4	19-235547	B6-Sport	22-227799	B4	22-235688	B6-Sport	24-158848	B8-5100
19-219097	B4	19-235585	B8	22-227812	B4	22-235695	B6-Sport	24-158930	B8-5100
19-219103	B4	19-235646	B6-Sport	22-227829	B4	22-235718	B8	24-166676	B4
19-219127	B4	19-235677	B8	22-227966	B4	22-235725	B8	24-169431	B4
19-219134	B4	19-235707	B6-Sport	22-227973	B4	22-235749	B6-Sport	24-184564	B6-4600
19-219158	B4	19-235738	B8	22-227980	B4	22-235756	B6-Sport	24-184601	B6-4600
19-219592	B4	19-235769	B6-Sport	22-227997	B4	22-235770	B8	24-184618	B8
19-220567	B4	19-235790	B8	22-228000	B4	22-235787	B8	24-184632	B6-4600
19-221427	B4	19-235837	B6-Sport	22-228017	B4	22-235817	B6-Sport	24-184656	B6-Sport
19-221694	B4	19-235868	B8	22-228062	B4	22-235824	B6-Sport	24-184663	B6-4600
19-221700	B4	19-235905	B6-Sport	22-228109	B4	22-235848	B8	24-184762	B6-4600
19-222073	B4	19-235936	B8	22-228116	B4	22-235855	B8	24-184809	B6-4600
19-223483	B4	19-235974	B6-Sport	22-228123	B4	22-235886	B6-Sport	24-184847	B6-4600

# New in the range 2014

Order-No.	Type	Order-No.	Type	Order-No.	Type	Order-No.	Type	Order-No.	Type
24-184854	B6-4600	24-187183	B8-5100	24-232074	B8	33-186542	B8-5100	36-211074	B3
24-184885	B6-4600	24-187190	B8-5100	24-232111	B6-Sport	33-186887	B8-5100	36-211340	B3
24-184915	B6-4600	24-187206	B8-5100	24-232142	B8	33-187228	B8-5100	36-211371	B3
24-184922	B6-4600	24-187213	B8-5100	24-232173	B8-5100	33-187266	B6-4600	36-211401	B3
24-184984	B6-4600	24-187237	B8-5100	24-232609	B6-Sport	33-187280	B8-5100	36-212606	B3
24-185004	B6-4600	24-187244	B6-4600	24-232890	B6-Sport	33-187297	B8-5100	36-212620	B3
24-185011	B6-4600	24-187251	B6-4600	24-232968	B6-Sport	33-187396	B6-4600	36-212637	B3
24-185080	B6-4600	24-187275	B8-5100	24-232975	B8	33-187419	B6-4600	36-214440	B3
24-185097	B6-4600	24-187381	B6-4600	24-233118	B6-Sport	33-187471	B8-5100	36-216901	B3
24-185134	B6-4600	24-187404	B6-4600	24-233293	B6-Sport	33-187501	B8-5100	36-220144	B3
24-185141	B6-4600	24-187428	B6-4600	24-233309	B8	33-187532	B6-4600	36-222209	B3
24-185158	B6-4600	24-187435	B6-4600	24-233613	MS	33-188218	B6-4600	36-222216	B3
24-185165	B6-4600	24-187466	B8-5100	24-233637	MS	33-225807	B8-5100	36-222223	B3
24-185172	B6-4600	24-187497	B8-5100	24-233880	B6-Sport	34-001554	MS	36-222285	B3
24-185189	B6-4600	24-187824	B6-4600	24-233958	B8	34-184530	B8	36-222292	B3
24-185196	B6-4600	24-187831	B6-4600	24-236577	B4	34-186350	B8	36-222377	B3
24-185202	B6-4600	24-188036	B6-4600	24-236584	B4	34-236406	MS	36-222384	B3
24-185219	B6-4600	24-188180	B8-5100	24-236997	MS	34-236437	MS	36-222403	B3
24-185226	B6-4600	24-188197	B8-5100	24-237338	B8	34-237229	B6-Sport	36-225859	B3
24-185257	B8-5100	24-188227	B6-4600	24-238588	B8	34-237236	MS	36-225866	B3
24-185264	B8-5100	24-188234	B6-4600	24-239110	B6-Sport	34-237243	MS	36-225873	B3
24-185325	B6-4600	24-188265	B8-5100	24-239134	B6-Sport	34-237250	MS	36-225880	B3
24-185356	B6-Sport	24-188272	B6-4600	24-239943	B6-Sport	35-045939	B6-Sport	36-225897	B3
24-185387	B6-4600	24-188296	B6-4600	24-239950	B6-Sport	35-207207	B6-Sport	36-225927	B3
24-185394	B6-4600	24-188302	B6-4600	24-242110	B6-Sport	35-207214	B8	36-225958	B3
24-185400	B8-5100	24-188401	B6-4600	24-242127	B8	35-207481	B6-Sport	36-225965	B3
24-185417	B8-5100	24-191197	B6-4600	24-242707	B6-Sport	35-207504	B8	36-225972	B3
24-185448	B6-4600	24-191203	B8-5100	24-243742	B8	35-209652	B6-Sport	36-225989	B3
24-185455	B6-4600	24-192941	B6-4600	24-848879	MS	35-221449	MS	36-225996	B3
24-185462	B6-4600	24-196277	B6-4600	25-176407	B8-5100	35-222958	B6-Sport	36-226009	B3
24-185479	B6-4600	24-196284	B8-5100	25-176414	B8-5100	35-222965	B6-Sport	36-226016	B3
24-185493	B8-5100	24-197427	B6-4600	25-177343	B8-5100	35-223627	B6-Sport	36-226030	B3
24-185509	B8-5100	24-197434	B6-4600	25-177411	B8-5100	35-223634	B6-Sport	36-226054	B3
24-185523	B8-5100	24-197649	B8-5100	25-177428	B8-5100	35-223641	B6-Sport	36-226061	B3
24-185530	B8-5100	24-197779	B6-4600	25-177435	B8-5100	35-223658	B6-Sport	36-226078	B3
24-185615	B8-5100	24-199445	B6-Sport	25-177442	B8-5100	35-225058	B6-Sport	36-226085	B3
24-185622	B8-5100	24-199452	B6-Sport	25-177893	B8-5100	35-225065	B6-Sport	36-226092	B3
24-185639	B8-5100	24-202633	B6-Sport	25-187595	B8-5100	35-225089	B6-Sport	36-226122	B3
24-185653	B8-5100	24-209755	B6-Sport	25-187601	B8-5100	35-225096	B6-Sport	36-226146	B3
24-185660	B8-5100	24-209779	B6-Sport	25-187618	B8-5100	35-225102	B8	36-226153	B3
24-185677	B6-4600	24-210294	B6-Sport	25-187625	B8-5100	35-225119	B8	36-226160	B3
24-185745	B8-5100	24-214001	B4	25-187632	B8-5100	35-225133	B8	36-226177	B3
24-185752	B8-5100	24-214018	B6-4600	25-187649	B8-5100	35-225140	B8	36-226252	B3
24-185776	B8-5100	24-214070	B4	25-187656	B8-5100	35-227526	B6-Sport	36-226924	B3
24-185783	B8-5100	24-216562	B6-4600	25-187663	B8-5100	35-227533	B6-Sport	36-226931	B3
24-185813	B6-4600	24-216579	B6-Sport	25-187670	B8-5100	35-228370	B6-Sport	36-226993	B3
24-185912	B8-5100	24-216951	B6-Sport	25-187687	B8-5100	35-228387	B6-Sport	36-227136	B3
24-185929	B8-5100	24-217675	B6-Sport	25-187694	B8-5100	35-228417	B8	36-227167	B3
24-185943	B8-5100	24-218269	B6-Sport	25-187779	B8-5100	35-228424	B8	36-227174	B3
24-185950	B8-5100	24-218283	B8	25-187786	B8-5100	35-229865	B6-Sport	36-227181	B3
24-185974	B6-Sport	24-218641	B6-Sport	25-187793	B8-5100	35-229872	B6-Sport	36-227211	B3
24-185981	B6-4600	24-218689	B6-Sport	25-187809	B8-5100	35-229902	B8	36-227228	B3
24-186018	B8-5100	24-221948	B6-4600	25-187816	B8-5100	35-229919	B8	36-227235	B3
24-186025	B8-5100	24-222099	B6-Sport	25-188363	B8-5100	35-231172	B6-Sport	36-227402	B3
24-186056	B6-4600	24-222112	B8	25-188370	B8-5100	35-231189	B6-Sport	36-227433	B3
24-186063	B6-4600	24-222426	B6-Sport	25-188387	B8-5100	35-231646	B6-Sport	36-227440	B3
24-186070	B6-4600	24-222976	B6-Sport	25-188394	B8-5100	35-232582	B6-Sport	36-227464	B3
24-186087	B6-4600	24-223416	B6-Sport	25-193114	B8-5100	35-232599	B6-Sport	36-227488	B3
24-186094	B6-4600	24-223447	B8	25-193121	B8-5100	35-232872	B6-Sport	36-227495	B3
24-186155	B6-4600	24-223911	B6-Sport	25-193138	B8-5100	35-232889	B6-Sport	36-227967	B3
24-186193	B6-4600	24-223928	B6-Sport	25-193145	B8-5100	35-233091	B6-Sport	36-229703	B3
24-186209	B6-4600	24-223942	B6-Sport	25-194012	B8-5100	35-233107	B6-Sport	36-230150	B3
24-186216	B8-5100	24-223980	B4	25-197754	B8-5100	35-233312	B6-Sport	36-230242	B3
24-186223	B8-5100	24-225076	B6-Sport	25-197761	B8-5100	35-233596	MS	36-230259	B3
24-186230	B6-4600	24-225397	B8	25-227611	B8-5100	35-233602	MS	36-230600	B3
24-186247	B6-4600	24-225410	B6-4600	26-220000	B4-DTC	35-234913	B6-Sport	36-230778	B3
24-186261	B6-4600	24-225427	B6-4600	26-220017	B4-DTC	35-236429	B6-Sport	36-231430	B3
24-186575	B6-4600	24-225434	B8-5100	26-220024	B4-DTC	35-236818	B6-Sport	36-231591	B3
24-186636	B8-5100	24-225441	B8-5100	26-220031	B4-DTC	35-238560	B8	36-232406	B3
24-186643	B8-5100	24-225793	B8-5100	26-231303	B6-DTC	35-238614	B8	36-232796	B3
24-186674	B6-4600	24-226776	B4	26-234229	B6-DTC	35-238744	B8	36-232932	B3
24-186681	B8-5100	24-227544	B6-Sport	26-237138	B6-DTC	35-239611	B6-Sport	36-232949	B3
24-186698	B8-5100	24-228398	B6-Sport	26-237145	B6-DTC	35-239628	B8	36-233175	B3
24-186704	B8-5100	24-228435	B8	28-188629	B6-Sport	35-240938	MS	36-233250	B3
24-186711	B8-5100	24-228992	B4	28-240921	MS	35-240945	MS	36-233274	B3
24-186728	B8-5100	24-229005	B4	31-231299	B6-DTC	35-242215	B6-Sport	36-233281	B3
24-186735	B8-5100	24-229050	B4	31-234207	B6-DTC	35-242222	B6-Sport	36-233540	B3
24-186742	B8-5100	24-229258	B8	31-602068	MS	35-242239	B8	36-233564	B3
24-186766	B8-5100	24-229753	B4	31-602075	MS	35-242246	B8	36-233571	B3
24-186773	B8-5100	24-229760	B4	33-028187	B6-4600	35-591177	MS	36-233588	B3
24-186810	B8-5100	24-229883	B6-Sport	33-061399	B8-5100	35-591184	MS	36-233625	B3
24-186827	B8-5100	24-229890	B6-Sport	33-066868	B8-5100	35-623809	MS	36-233649	B3
24-186834	B6-4600	24-229920	B8	33-151618	B8-5100	35-623816	MS	36-233663	B3
24-186841	B6-4600	24-229937	B8	33-151632	B8-5100	36-200993	B3	36-233694	B3
24-186872	B8-5100	24-230964	B4	33-151649	B8-5100	36-201327	B3	36-233779	B3
24-186926	B6-4600	24-231190	B6-Sport	33-151656	B8-5100	36-201334	B3	36-233793	B3
24-186933	B6-4600	24-231282	B6-Sport	33-151663	B8-5100	36-201341	B3	36-233861	B3
24-186940	B8-5100	24-231312	B6-Sport	33-151670	B8-5100	36-202911	B3	36-233892	B3
24-186957	B8-5100	24-231428	B8	33-170862	B8-5100	36-208913	B3	36-233908	B3
24-186964	B8-5100	24-231657	B6-Sport	33-174525	B8-5100	36-209590	B3	36-234042	B3
24-186971	B8-5100	24-231725	B4	33-185347	B6-4600	36-209644	B3	36-234233	B3
24-186988	B8-5100	24-231732	B4	33-185514	B8-5100	36-209682	B3	36-234240	B3
24-186995	B8-5100	24-231749	B4	33-185545	B8-5100	36-209705	B3	36-234356	B3
24-187053	B8-5100	24-231756	B4	33-185552	B8-5100	36-209712	B3	36-234660	B3
24-187077	B8-5100	24-231763	B4	33-185569	B8-5100	36-209736	B3	36-234677	B3
24-187084	B8-5100	24-231770	B4	33-185590	B8-5100	36-209743	B3	36-234684	B3
24-187091	B6-4600	24-231787	B4	33-185606	B8-5100	36-210213	B3	36-234691	B3
24-187121	B6-4600	24-231794	B4	33-185897	B6-4600	36-210312	B3	36-234707	B3
24-187152	B8-5100	24-231800	B4	33-185934	B8-5100	36-210329	B3	36-234714	B3
24-187169	B8-5100	24-231985	B6-Sport	33-186009	B8-5100	36-210350	B3	36-234950	B3



## New in the range 2014

Order-No.	Type	Order-No.	Type	Order-No.	Type	Order-No.	Type	Order-No.	Type
36-234967	B3	39-209009	B3-BF	46-206695	B12-PK	48-231848	B16-BCS		
36-234981	B3	39-209023	B3-BF	46-206718	B12-PK	48-231954	B16-BCS		
36-235209	B3	39-209030	B3-BF	46-206732	B12-PK	48-233132	B16-BCS		
36-235551	B3	39-209092	B3-BF	46-206749	B12-PK	48-236775	B16-BCS		
36-235568	B3	39-209108	B3-BF	46-206763	B12-PK	48-238212	B16-BCS		
36-236541	B3	39-209115	B3-BF	46-206770	B12-PK	48-238649	B16-BCS		
36-236909	B3	39-209122	B3-BF	46-206787	B12-PK	48-238946	B16-BCS		
36-237067	B3	39-209146	B3-BF	46-206800	B12-PK	49-207323	B16-RC		
36-237265	B3	39-209153	B3-BF	46-206848	B12-PK	49-231892	B16-RC		
36-237463	B3	39-209160	B3-BF	46-206862	B12-PK	49-234923	B16-DTC		
36-237791	B3	39-209177	B3-BF	46-206886	B12-PK	49-237108	B16-DTC		
36-237821	B3	39-209184	B3-BF	46-206909	B12-PK	49-237191	B16-DTC		
36-237845	B3	39-209191	B3-BF	46-206923	B12-PK	49-237276	B16-DTC		
36-237852	B3	39-209207	B3-BF	46-206930	B12-PK	53-001313	BSK		
36-237876	B3	39-209214	B3-BF	46-206947	B12-PK	53-001436	BSK		
36-237883	B3	39-209238	B3-BF	46-206954	B12-PK	53-001702	BSK		
36-237890	B3	39-209245	B3-BF	46-206961	B12-PK	53-001931	BSK		
36-237906	B3	39-209252	B3-BF	46-206985	B12-PK	53-002402	BSK		
36-237999	B3	39-209269	B3-BF	46-207005	B12-PK	53-002549	BSK		
36-239023	B3	39-209276	B3-BF	46-207036	B12-PK	53-005007	BSK		
36-239030	B3	39-209283	B3-BF	46-207043	B12-PK	53-006011	BSK		
36-239740	B3	39-209290	B3-BF	46-207050	B12-PK	53-007001	BSK		
36-239764	B3	39-209306	B3-BF	46-207067	B12-PK	53-008008	BSK		
36-239771	B3	39-209313	B3-BF	46-207074	B12-PK	53-011015	BSK		
36-239849	B3	39-209320	B3-BF	46-207081	B12-PK	53-012012	BSK		
36-240388	B3	39-209337	B3-BF	46-207098	B12-PK	53-230461	BSK		
36-240487	B3	39-209344	B3-BF	46-207104	B12-PK				
36-241095	B3	39-209351	B3-BF	46-207135	B12-PK				
36-241101	B3	39-209368	B3-BF	46-207159	B12-PK				
36-241118	B3	39-209375	B3-BF	46-207166	B12-PK				
36-241125	B3	39-209382	B3-BF	46-207173	B12-PK				
36-241132	B3	39-209399	B3-BF	46-207180	B12-PK				
36-241149	B3	39-209405	B3-BF	46-207197	B12-PK				
36-241156	B3	39-209412	B3-BF	46-222916	B12-PK				
36-241163	B3	39-209429	B3-BF	46-226617	B12-SL				
36-241170	B3	39-209436	B3-BF	46-228864	B12-PK				
36-241187	B3	39-209443	B3-BF	46-228888	B12-PK				
36-241194	B3	39-209467	B3-BF	46-229779	B12-PK				
36-241460	B3	39-209474	B3-BF	46-229786	B12-SL				
36-241477	B3	39-209481	B3-BF	46-229793	B12-PK				
36-241484	B3	39-209498	B3-BF	46-229809	B12-PK				
36-241491	B3	39-209504	B3-BF	46-229816	B12-PK				
36-241507	B3	39-209511	B3-BF	46-229823	B12-PK				
36-241514	B3	39-209528	B3-BF	46-229830	B12-PK				
36-241521	B3	39-209535	B3-BF	46-230904	B12-SL				
36-241545	B3	39-209542	B3-BF	46-230911	B12-SL				
36-241583	B3	39-209559	B3-BF	46-232823	B12-PK				
36-241590	B3	39-209566	B3-BF	46-234360	B12-PK				
36-242986	B3	39-209573	B3-BF	46-234377	B12-PK				
37-000820	B3	39-209580	B3-BF	46-234384	B12-PK				
37-154738	B3	39-210128	B3-BF	46-234391	B12-PK				
37-206307	B3	39-210401	B3-BF	46-237156	B12-PK				
37-209674	B3	39-220431	B3-BF	46-237538	B12-PK				
37-209896	B3	39-220899	B3-BF	46-237545	B12-PK				
37-210304	B3	39-220943	B3-BF	46-237552	B12-PK				
37-229177	B3	39-220967	B3-BF	46-237569	B12-SL				
37-230180	B3	39-222671	B3-BF	46-237576	B12-PK				
37-231583	B3	39-222855	B3-BF	46-237583	B12-SL				
37-233051	B3	39-222860	B3-BF	46-237927	B12-PK				
37-235949	B3	39-229069	B3-BF	46-240194	B12-PK				
37-236052	B3	39-230027	B3-BF	46-240309	B12-PK				
37-238995	B3	39-230126	B3-BF	47-107991	B14				
37-239701	B3	39-230133	B3-BF	47-207233	B14				
37-239718	B3	39-231321	B3-BF	47-217706	B14				
37-239725	B3	39-231819	B3-BF	47-225176	B14				
37-239794	B3	40-221601	B3-AMC	47-225183	B14				
37-239800	B3	40-221618	B3-AMC	47-228078	B14				
37-239817	B3	40-231990	B3-AMC	47-228146	B14				
37-240448	B3	40-232003	B3-AMC	47-228214	B14				
37-242091	B3	40-240732	B4-AMC	47-228337	B14				
37-242107	B3	44-139872	B4	47-229945	B14				
38-228599	B3	44-139889	B4-DTC	47-229952	B14				
38-233265	B3	44-218669	B6-4600	47-229969	B14				
38-233654	B3	44-218676	B6-4600	47-229976	B14				
38-233715	B3	44-219215	B4-AMC	47-231108	B14				
38-235801	B3	44-219222	B4-AMC	47-231207	B14				
38-236198	B3	44-232726	B4-DTC	47-232952	B14				
38-236389	B3	44-232733	B4-DTC	47-233942	B14				
38-236655	B3	44-236595	B4-AMC	47-235106	B14				
38-240508	B3	44-236601	B4-AMC	47-237308	B14				
38-241536	B3	44-236618	B6-4600	47-238602	B14				
38-242205	B3	44-236625	B6-4600	47-239180	B14				
39-202352	B3-BF	45-218644	B4-AMC	47-239197	B14				
39-202413	B3-BF	45-218651	B4-AMC	47-242043	B14				
39-203427	B3-BF	45-240690	B4-AMC	47-242104	B14				
39-203489	B3-BF	45-240706	B4-AMC	47-242135	B14				
39-203700	B3-BF	45-240713	B4-AMC	47-242142	B14				
39-203793	B3-BF	45-240720	B4-AMC	48-101288	B16-PSS9				
39-203991	B3-BF	45-241727	B4-AMC	48-207287	B16-PSS10				
39-204196	B3-BF	45-241734	B4-AMC	48-227018	B16-BCS				
39-204264	B3-BF	46-180056	B12-PK	48-227186	B16-PSS10				
39-206022	B3-BF	46-191984	B12-BTK	48-228299	B16-PSS10				
39-206053	B3-BF	46-191991	B12-BTK	48-229012	B16-PSS10				
39-208132	B3-BF	46-193575	BSK	48-229333	B16-BCS				
39-208163	B3-BF	46-193612	B12-PK	48-230032	B16-PSS10				
39-208330	B3-BF	46-198297	B12-PK	48-230049	B16-PSS10				
39-208965	B3-BF	46-200402	B12-PK	48-230056	B16-PSS10				
39-208972	B3-BF	46-206657	B12-PK	48-230063	B16-PSS10				
39-208989	B3-BF	46-206671	B12-PK	48-230834	B16-BCS				
39-208996	B3-BF	46-206688	B12-PK	48-230971	B16-PSS10				

# Obsolete range 2014



Obsolete	replaced by Order-No.	Obsolete	replaced by Order-No.	Obsolete	replaced by Order-No.	Obsolete	replaced by Order-No.
11-101383		22-169259		36-129799	36-226061	36-160907	
11-101420		22-169945		36-129805	36-226078	36-160914	
11-101482		22-169952		36-130061	36-133413	36-160921	
12-117710		22-170408		36-130641	36-134083	36-160945	
12-117727		22-170415		36-130696	36-226252	36-160952	
12-224166	12-238026	22-171528		36-130702	36-226085	36-161041	
12-224210	12-238033	22-173089		36-130740	36-227464	36-161072	
12-224272	12-238088	22-173096		36-130764	36-225965	36-161133	
19-019352		22-176158		36-130863	36-225972	36-161195	
19-019789		22-176165		36-131051	36-225989	36-161249	
19-019796		22-181657	35-043959	36-131075	36-234981	36-161348	36-161355
19-061047	19-238784	22-183460		36-131136	36-226092	36-161362	36-161379
19-061146		22-183484		36-131204	36-227488	36-161386	36-161393
19-062839		22-183491		36-131310	36-232987	36-161454	
19-062846		22-183507		36-133086		36-161461	
19-062945		22-183583		36-133154		36-161515	
19-062952		22-183590		36-133239		36-161522	
19-063195		22-193360	22-235336	36-133246	36-229697	36-161591	
19-063225		22-196743		36-133482	36-133345	36-161676	
19-063485		22-196750		36-133581		36-161713	
19-068572		22-213945		36-133604		36-161768	
19-068848	19-068855	22-213952		36-133611		36-161812	
19-111131	19-219080	22-214775		36-133680	36-226160	36-161829	
19-112909	19-219097	22-214782		36-133789	36-227228	36-161935	
19-112916	19-219103	22-217714		36-133819	36-129737	36-162062	
19-113098	19-238791	24-000307		36-133826	36-133833	36-162222	
19-119335		24-000628		36-133895		36-162260	
19-131627	19-223322	24-003162		36-134182	36-155095	36-162307	
19-152622	19-219127	24-003209		36-134342		36-162338	
19-152639	19-219134	24-003858		36-148097	36-300068	36-162390	
19-158976		24-010214	24-225397	36-153862		36-162475	
19-168555		24-013079	24-187428	36-153879	36-129348	36-162499	
19-184180	19-219073	24-020404		36-154012	36-226993	36-162512	
21-193347		24-020909		36-154043	36-227136	36-162550	
22-040091	35-044024	24-024174		36-154074	36-226122	36-162604	
22-040107	35-044031	24-024181	24-104050	36-154166	36-226030	36-162635	
22-040794		24-024242	24-104050	36-154265		36-162659	
22-041401		24-025782	24-010450	36-154272		36-162741	
22-041982		24-026055		36-154333		36-162765	
22-044396	35-114079	24-026611		36-154685	36-227402	36-162857	
22-044402	35-114086	24-026901		36-154715	36-231430	36-162888	
22-044419	35-114093	24-066471		36-154722		36-162987	
22-045713	22-205414	24-069540	24-065092	36-154807	36-233892	36-163007	
22-045799	22-230959	24-101707		36-154869		36-163021	
22-047328		24-116237	24-197656	36-154883		36-163083	
22-047335		24-122610		36-154890		36-163106	
22-047885		24-122627		36-154913	36-227440	36-163120	
22-047892		24-152921	24-214018	36-154944		36-163137	
22-048141		24-184748	24-014960	36-155118	36-227495	36-163168	
22-048189		24-197069	24-239943	36-159048		36-163182	
22-048196		24-197076	24-239950	36-159147		36-163199	
22-048233		24-577403	24-221726	36-159178		36-163205	
22-048318		24-593762	24-176422	36-159222		36-163243	
22-048707		24-634649	24-632805	36-159239		36-163250	
22-048714		25-177909	25-227611	36-159284		36-163366	36-163878
22-048721		26-181943		36-159307		36-163380	
22-048967		26-181950		36-159314		36-163403	
22-049209		26-181967		36-159321		36-163410	
22-049308		26-181974		36-159376		36-163588	
22-049407		26-181981		36-159420	36-235209	36-163618	36-229703
22-052698		26-181998		36-159444		36-163625	36-227433
22-102089	22-223616	26-182001		36-159468		36-163649	36-163656
22-106742		26-182018		36-159475		36-163687	
22-113108	22-226556	26-182025		36-159512	36-233908	36-163694	36-163687
22-121349		26-182032		36-159536		36-163779	36-227211
22-121356		27-029732		36-159567	36-159543	36-163786	
22-122483	22-228000	34-000557	34-000533	36-159635		36-163847	
22-136244	22-228017	34-000564	34-000540	36-159697		36-163861	
22-136251	22-227966	34-000748		36-159734		36-163885	
22-151025	22-196019	34-000779		36-159765		36-163922	
22-153746	22-215826	34-002681		36-159864		36-164004	
22-153753	22-215819	34-188620		36-159888		36-164042	
22-158444		35-003984		36-159925		36-164059	
22-158451		35-041283		36-159994		36-164066	
22-158857		35-043126		36-160013		36-164073	
22-158864		35-051442	35-238744	36-160068		36-164080	
22-158901	22-226563	35-101680		36-160266		36-164097	
22-164773	22-227997	35-118657	35-114093	36-160280		36-164110	
22-165022		35-156338		36-160310		36-164295	36-133208
22-165039		35-156345		36-160327		36-164325	
22-166258		36-129140	36-225859	36-160341		36-164388	
22-166265		36-129317	36-226924	36-160358		36-195459	
22-166357		36-129331	36-225866	36-160372		36-195473	
22-166364		36-129355	36-225873	36-160389	36-233175	36-195480	
22-166432		36-129362	36-225880	36-160464		36-195497	
22-166814		36-129379	36-225996	36-160471		36-195503	
22-166821		36-129386	36-225897	36-160488		36-195534	
22-166838		36-129423	36-226009	36-160495		36-195565	
22-166845		36-129430	36-226931	36-160501		36-195589	
22-166920		36-129522	36-226016	36-160518		36-195602	
22-166937		36-129539	36-224043	36-160549		36-195633	36-195442
22-167026		36-129560	36-227167	36-160556		36-195787	36-130740
22-167033		36-129614	36-233779	36-160600		36-196081	
22-167095		36-129645	36-227174	36-160723		36-196128	
22-167101		36-129652	36-227181	36-160730		36-196142	
22-168467		36-129690	36-225927	36-160747		36-196166	
22-168474		36-129713	36-225958	36-160778		36-196173	
22-168535		36-129737	36-227235	36-160785		36-197880	36-209705
22-168542		36-129751	36-226177	36-160839		36-197910	
22-169242		36-129782	36-226054	36-160891		36-199525	36-131297



# Obsolete range 2014

Obsolete	replaced by Order-No.	Obsolete	replaced by Order-No.	Obsolete	replaced by Order-No.	Obsolete	replaced by Order-No.
36-199587	37-160654	36-219049					
36-200269	36-200009	36-219148					
36-200405		36-219308					
36-200412	36-200726	36-219315					
36-200535	36-200795	36-219353					
36-200665	36-200764	36-219360					
36-200757	36-200610	36-219384					
36-200771	36-200634	36-219391					
36-200801	36-131228	36-219407					
36-200832	36-200788	36-219414					
36-201167	36-200993	36-219438					
36-201730	37-131432	36-219445					
36-201822	36-201341	36-219537					
36-201891	37-134211	36-219551					
36-201969	36-155101	36-219568					
36-202157		36-219575					
36-202188		36-219605					
36-202584		36-219612					
36-202683		36-219674					
36-202706		36-219698	36-219711				
36-202713		36-219704	36-219681				
36-202720		36-219728	36-219735				
36-202737	36-216901	36-219766	36-219872				
36-202744		36-219780					
36-202768		36-219797					
36-202782		36-219803					
36-203000		36-219810					
36-214433		36-219902	36-130771				
36-214846		36-222438					
36-214969		36-300013	36-203284				
36-214976		36-300051	36-148073				
36-214983		37-130930	37-131425				
36-215379	36-219285	37-148485	37-161309				
36-215409		37-148492	37-161293				
36-215416		37-153991	36-226146				
36-215645		37-154127	36-226153				
36-215652		37-154646	37-233051				
36-215676		37-159801	37-161262				
36-216208	36-216215	37-160531	37-161279				
36-216277		37-161286	37-148508				
36-216314		37-163372	37-154738				
36-216390		37-164218	37-161019				
36-216406		37-172183	37-000820				
36-216413		38-130458	38-225819				
36-216420		38-153907					
36-216437		38-154089	38-236389				
36-216444		38-162343					
36-216475	36-234356	39-208217					
36-216598	36-216604	40-148335	40-148342				
36-216628		46-000057					
36-216734	36-216727	46-000088					
36-216772		46-180704					
36-216826		46-182463					
36-216840		46-182913					
36-216857		46-182944					
36-216864		46-182951					
36-216871		46-188816					
36-216888		46-189394					
36-217014		46-189585					
36-217021		46-190048					
36-217038		46-190147					
36-217045		46-190192					
36-217052	36-217069	46-190970					
36-217090		46-190994					
36-217106		46-191007					
36-217113		46-191038					
36-217120		46-192462					
36-217168		46-192479					
36-217243		46-194206					
36-217250		46-194213					
36-217267		47-101746					
36-217281		47-121928					
36-217298		47-172708					
36-217304		48-086202	48-103398				
36-217311							
36-217342							
36-217359							
36-217380							
36-217472							
36-217496							
36-217502							
36-217519							
36-217588							
36-217595	36-217571						
36-217601	36-217571						
36-217618							
36-217625							
36-217632							
36-217649							
36-217847							
36-218134							
36-218141							
36-218158							
36-218349							
36-218837							
36-218943							
36-218974							
36-218981							
36-218998							
36-219032							





# Protection kits





## Protection kit > Order-No.

Protection kit	Order-Nr.	Location	Protection kit	Order-Nr.	Location	Protection kit	Order-Nr.	Location
11-101291	22-219589	V	11-101352	19-019949	H	11-106487	15-104311	H
11-101291	22-239594	V	11-101352	19-019963	H	11-115755	19-196312	H
11-101291	21-030338	V	11-101352	19-028651	H	11-115755	24-025430	H
11-101291	21-030468	V	11-101352	19-028668	H	11-115755	24-025447	H
11-101291	21-030550	V	11-101352	19-029405	H	11-115755	24-026239	H
11-101291	21-031502	V	11-101352	19-029412	H	11-115755	24-026246	H
11-101291	16-031340	V	11-101352	19-124681	H	11-115755	24-028004	H
11-101291	16-031456	V	11-101352	15-062192	H	11-115755	24-028011	H
11-101291	35-003663	V	11-101352	15-062208	H	11-115755	24-064095	H
11-101291	22-181657	V	11-101352	15-069122	H	11-115755	24-064101	H
11-101291	22-003737	V	11-101352	15-105257	H	11-115755	19-029160	H
11-101291	22-004062	V	11-101352	15-106377	H	11-115755	19-029177	H
11-101291	22-040589	V	11-101369	21-030260	V	11-115755	19-029429	H
11-101291	22-041364	V	11-101369	21-030376	V	11-115755	19-068633	H
11-101291	22-041371	V	11-101369	16-031548	V	11-115755	19-109572	H
11-101291	35-043911	V	11-101376	21-030475	V	11-115755	19-140032	H
11-101291	22-043085	V	11-101376	22-040916	V	11-116141	22-045737	V
11-101291	22-043092	V	11-101376	22-045683	V	11-122449	21-030475	V
11-101291	22-041142	V	11-101376	22-128300	V	11-122456	22-031204	V
11-101291	22-041180	V	11-101376	17-053310	V	11-122456	22-044808	V
11-101291	22-041227	V	11-101376	17-053327	V	11-125358	22-215734	V
11-101291	22-041234	V	11-101390	24-020800	H	11-125358	22-215796	V
11-101291	22-045010	V	11-101390	24-020824	H	11-125358	22-215802	V
11-101291	22-045027	V	11-101390	24-181495	H	11-125358	22-215819	V
11-101291	22-045768	V	11-101390	24-016193	H	11-125358	22-215826	V
11-101291	17-047142	V	11-101390	24-025331	H	11-125358	22-215833	V
11-101291	17-047166	V	11-101390	24-062596	H	11-125358	22-215840	V
11-101291	17-104029	V	11-101390	19-019642	H	11-125358	22-153739	V
11-101291	17-105248	V	11-101390	19-019949	H	11-125358	22-153746	V
11-101291	17-107150	V	11-101390	19-029207	H	11-125358	22-153753	V
11-101307	22-224668	V	11-101390	19-103471	H	11-125358	22-153760	V
11-101307	22-239594	V	11-101406	22-001856	V	11-125358	22-153777	V
11-101307	21-030338	V	11-101406	22-001900	V	11-125358	22-153784	V
11-101307	21-030406	V	11-101406	22-001917	V	11-125358	22-153791	V
11-101307	21-030444	V	11-101406	22-001924	V	11-149828	19-067803	H
11-101307	16-031296	V	11-101406	22-001993	V	11-149828	19-109565	H
11-101307	16-031319	V	11-101406	22-002006	V	11-149835	24-065153	H
11-101307	22-041364	V	11-101406	22-003614	V	11-149835	24-065177	H
11-101307	22-041371	V	11-101406	22-003621	V	11-149835	24-119795	H
11-101307	22-040978	V	11-101406	22-040534	V	11-149835	24-119825	H
11-101307	22-044761	V	11-101413	19-019697	H	11-149835	19-029443	H
11-101307	17-104029	V	11-101437	22-040961	V	11-149835	19-111797	H
11-101307	17-106405	V	11-101437	22-041029	V	11-149835	19-111803	H
11-101314	22-193360	V	11-101451	19-020174	H	11-149835	19-140049	H
11-101314	22-230959	V	11-101468	22-041012	V	11-181415	19-220598	H
11-101314	22-235336	V	11-101468	22-041241	V	11-181415	24-233613	H
11-101314	21-030413	V	11-101468	22-045522	V	11-181415	24-015257	H
11-101314	21-030437	V	11-101468	22-045539	V	11-181415	24-015264	H
11-101314	21-030529	V	11-101468	22-045546	V	11-181415	24-026970	H
11-101314	16-031302	V	11-101468	22-045553	V	11-181415	24-026987	H
11-101314	16-031333	V	11-101468	22-045560	V	11-181415	24-067577	H
11-101314	16-031548	V	11-101468	22-139993	V	11-181415	24-068659	H
11-101314	22-040152	V	11-101499	22-040992	V	11-181415	24-068666	H
11-101314	22-040909	V	11-101499	22-041005	V	11-181415	24-027243	H
11-101314	17-104104	V	11-101499	22-045508	V	11-181415	24-027250	H
11-101321	22-196309	V	11-101499	22-045942	V	11-181415	19-103112	H
11-101321	22-217271	V	11-101499	22-051813	V	11-181415	19-103150	H
11-101321	21-030246	V	11-101918	21-030291	V	11-239734	34-003695	V
11-101321	21-030253	V	11-101918	21-030383	V	11-239734	34-003701	V
11-101321	21-030499	V	11-101918	22-045461	V	12-167616	24-124362	V
11-101321	21-030505	V	11-101918	22-052544	V	12-167616	24-166652	V
11-101321	21-030512	V	11-101918	22-107985	V			
11-101321	21-031182	V	11-103455	22-045744	V			
11-101321	21-031199	V	11-103455	22-045751	V			
11-101321	16-031326	V	11-103455	22-131607	V			
11-101321	16-101920	V	11-103455	22-131614	V			
11-101321	22-040879	V	11-103455	22-139184	V			
11-101321	22-041210	V	11-103455	22-139191	V			
11-101321	22-105813	V	11-103462	24-020800	H			
11-101338	22-040770	V	11-103462	24-020824	H			
11-101338	22-040855	V	11-103462	24-027007	H			
11-101338	22-040886	V	11-103462	24-062596	H			
11-101338	22-040893	V	11-103462	19-103471	H			
11-101338	22-040930	V	11-103462	19-105376	H			
11-101338	22-041135	V	11-103622	21-030543	V			
11-101338	22-041159	V	11-103943	21-030390	V			
11-101338	22-041173	V	11-103943	16-031289	V			
11-101338	22-045546	V	11-104322	24-020473	H			
11-101338	22-045553	V	11-104322	24-020480	H			
11-101338	17-053273	V	11-104322	19-028491	H			
11-101345	24-008372	H	11-104322	15-107077	H			
11-101345	24-015141	H	11-104957	22-045607	V			
11-101345	19-019550	H	11-104957	22-045614	V			
11-101345	19-019680	H	11-104964	22-045584	H			
11-101345	19-019802	H	11-104964	22-045621	H			
11-101352	24-000307	H	11-105886	19-029306	H			
11-101352	24-014175	H	11-105886	19-029320	H			
11-101352	24-015042	H	11-105886	19-029337	H			
11-101352	24-015240	H	11-105886	19-104089	H			
11-101352	24-015295	H	11-106470	19-196312	H			
11-101352	24-015530	H	11-106470	19-236971	H			
11-101352	24-015974	H	11-106470	24-021197	H			
11-101352	24-021197	H	11-106470	24-021227	H			
11-101352	24-021227	H	11-106470	24-067898	H			
11-101352	24-026017	H	11-106470	24-067904	H			
11-101352	24-026192	H	11-106470	19-109572	H			
11-101352	24-026208	H	11-106470	19-109589	H			
11-101352	19-019659	H	11-106470	19-128863	H			
11-101352	19-019741	H	11-106470	15-104311	H			
11-101352	19-019932	H	11-106487	19-028484	H			

# Order-No. > Protection kit

Order-No.	Protection kit	Location	Order-No.	Protection kit	Location	Order-No.	Protection kit	Location
15-062192	11-101352	H	21-031182	11-101321	V	22-235336	11-101314	V
15-062208	11-101352	H	21-031199	11-101321	V	22-239594	11-101291	V
15-069122	11-101352	H	21-031502	11-101291	V	22-239594	11-101307	V
15-104311	11-106470	H	22-001856	11-101406	V	24-000307	11-101352	H
15-104311	11-106487	H	22-001900	11-101406	V	24-008372	11-101345	H
15-105257	11-101352	H	22-001917	11-101406	V	24-014175	11-101352	H
15-106377	11-101352	H	22-001924	11-101406	V	24-015042	11-101352	H
15-107077	11-104322	H	22-001993	11-101406	V	24-015141	11-101345	H
16-031289	11-103943	V	22-002006	11-101406	V	24-015240	11-101352	H
16-031296	11-101307	V	22-003614	11-101406	V	24-015257	11-181415	H
16-031302	11-101314	V	22-003621	11-101406	V	24-015264	11-181415	H
16-031319	11-101307	V	22-003737	11-101291	V	24-015295	11-101352	H
16-031326	11-101321	V	22-004062	11-101291	V	24-015530	11-101352	H
16-031333	11-101314	V	22-031204	11-122456	V	24-015974	11-101352	H
16-031340	11-101291	V	22-040152	11-101314	V	24-016193	11-101390	H
16-031456	11-101291	V	22-040534	11-101406	V	24-020473	11-104322	H
16-031548	11-101314	V	22-040589	11-101291	V	24-020480	11-104322	H
16-031548	11-101369	V	22-040770	11-101338	V	24-020800	11-101390	H
16-101920	11-101321	V	22-040855	11-101338	V	24-020800	11-103462	H
17-047142	11-101291	V	22-040879	11-101321	V	24-020824	11-101390	H
17-047166	11-101291	V	22-040886	11-101338	V	24-020824	11-103462	H
17-053273	11-101338	V	22-040893	11-101338	V	24-021197	11-101352	H
17-053310	11-101376	V	22-040909	11-101314	V	24-021197	11-106470	H
17-053327	11-101376	V	22-040916	11-101376	V	24-021227	11-101352	H
17-104029	11-101291	V	22-040930	11-101338	V	24-021227	11-106470	H
17-104029	11-101307	V	22-040961	11-101437	V	24-025331	11-101390	H
17-104104	11-101314	V	22-040978	11-101307	V	24-025430	11-115755	H
17-105248	11-101291	V	22-040992	11-101499	V	24-025447	11-115755	H
17-106405	11-101307	V	22-041005	11-101499	V	24-026017	11-101352	H
17-107150	11-101291	V	22-041012	11-101468	V	24-026192	11-101352	H
19-019550	11-101345	H	22-041029	11-101437	V	24-026208	11-101352	H
19-019642	11-101390	H	22-041135	11-101338	V	24-026239	11-115755	H
19-019659	11-101352	H	22-041142	11-101291	V	24-026246	11-115755	H
19-019680	11-101345	H	22-041159	11-101338	V	24-026970	11-181415	H
19-019697	11-101413	H	22-041173	11-101338	V	24-026987	11-181415	H
19-019741	11-101352	H	22-041180	11-101291	V	24-027007	11-103462	H
19-019802	11-101345	H	22-041210	11-101321	V	24-027243	11-181415	H
19-019932	11-101352	H	22-041227	11-101291	V	24-027250	11-181415	H
19-019949	11-101352	H	22-041234	11-101291	V	24-028004	11-115755	H
19-019949	11-101390	H	22-041241	11-101468	V	24-028011	11-115755	H
19-019963	11-101352	H	22-041364	11-101291	V	24-062596	11-101390	H
19-020174	11-101451	H	22-041364	11-101307	V	24-062596	11-103462	H
19-028484	11-106487	H	22-041371	11-101291	V	24-064095	11-115755	H
19-028491	11-104322	H	22-041371	11-101307	V	24-064101	11-115755	H
19-028651	11-101352	H	22-043085	11-101291	V	24-065153	11-149835	H
19-028668	11-101352	H	22-043092	11-101291	V	24-065177	11-149835	H
19-029160	11-115755	H	22-044761	11-101307	V	24-067577	11-181415	H
19-029177	11-115755	H	22-044808	11-122456	V	24-067898	11-106470	H
19-029207	11-101390	H	22-045010	11-101291	V	24-067904	11-106470	H
19-029306	11-105886	H	22-045027	11-101291	V	24-068659	11-181415	H
19-029320	11-105886	H	22-045461	11-101918	V	24-068666	11-181415	H
19-029337	11-105886	H	22-045508	11-101499	V	24-119795	11-149835	H
19-029405	11-101352	H	22-045522	11-101468	V	24-119825	11-149835	H
19-029412	11-101352	H	22-045539	11-101468	V	24-124362	12-167616	V
19-029429	11-115755	H	22-045546	11-101338	V	24-166652	12-167616	V
19-029443	11-149835	H	22-045546	11-101468	V	24-181495	11-101390	H
19-067803	11-149828	H	22-045553	11-101338	V	24-233613	11-181415	H
19-068633	11-115755	H	22-045553	11-101468	V	34-003695	11-239734	V
19-103112	11-181415	H	22-045560	11-101468	V	34-003701	11-239734	V
19-103150	11-181415	H	22-045584	11-104964	H	35-003663	11-101291	V
19-103471	11-101390	H	22-045607	11-104957	V	35-043911	11-101291	V
19-103471	11-103462	H	22-045614	11-104957	V			
19-104089	11-105886	H	22-045621	11-104964	H			
19-105376	11-103462	H	22-045683	11-101376	V			
19-109565	11-149828	H	22-045737	11-116141	V			
19-109572	11-106470	H	22-045744	11-103455	V			
19-109572	11-115755	H	22-045751	11-103455	V			
19-109589	11-106470	H	22-045768	11-101291	V			
19-111797	11-149835	H	22-045942	11-101499	V			
19-111803	11-149835	H	22-051813	11-101499	V			
19-124681	11-101352	H	22-052544	11-101918	V			
19-128863	11-106470	H	22-105813	11-101321	V			
19-140032	11-115755	H	22-107985	11-101918	V			
19-140049	11-149835	H	22-128300	11-101376	V			
19-196312	11-106470	H	22-131607	11-103455	V			
19-196312	11-115755	H	22-131614	11-103455	V			
19-220598	11-181415	H	22-139184	11-103455	V			
19-236971	11-106470	H	22-139191	11-103455	V			
21-030246	11-101321	V	22-139993	11-101468	V			
21-030253	11-101321	V	22-153739	11-125358	V			
21-030260	11-101369	V	22-153746	11-125358	V			
21-030291	11-101918	V	22-153753	11-125358	V			
21-030338	11-101291	V	22-153760	11-125358	V			
21-030338	11-101307	V	22-153777	11-125358	V			
21-030376	11-101369	V	22-153784	11-125358	V			
21-030383	11-101918	V	22-153791	11-125358	V			
21-030390	11-103943	V	22-181657	11-101291	V			
21-030406	11-101307	V	22-193360	11-101314	V			
21-030413	11-101314	V	22-196309	11-101321	V			
21-030437	11-101314	V	22-215734	11-125358	V			
21-030444	11-101307	V	22-215796	11-125358	V			
21-030468	11-101291	V	22-215802	11-125358	V			
21-030475	11-101376	V	22-215819	11-125358	V			
21-030475	11-122449	V	22-215826	11-125358	V			
21-030499	11-101321	V	22-215833	11-125358	V			
21-030505	11-101321	V	22-215840	11-125358	V			
21-030512	11-101321	V	22-217271	11-101321	V			
21-030529	11-101314	V	22-219589	11-101291	V			
21-030543	11-103622	V	22-224668	11-101307	V			
21-030550	11-101291	V	22-230959	11-101314	V			



# Motorsport



e.g.: V E 3 - 4178 F S L

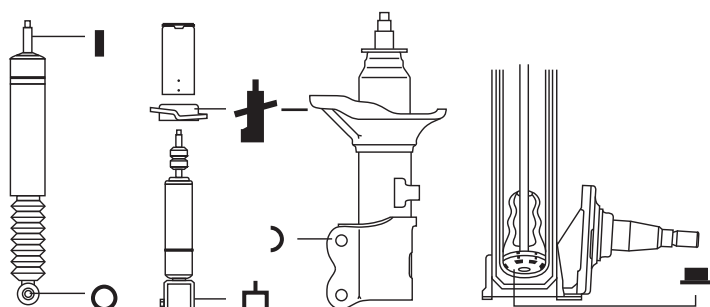
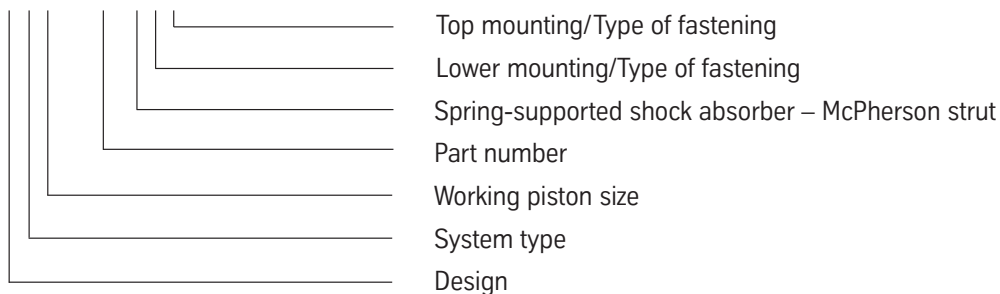

**Design**

- B** Shock absorber
- P** Cartridge
- R** Repair insert
- S** Sports kit
- V** Front/rear axle strut

**Systemart**

- E** Mono-tube system
- M** Manually adjustable
- N** Twin-tube system

**Size**

- 1** Ø 22 mm (B 22 - )
- 2** Ø 30 mm (P 30 - )
- 3** Ø 36 mm (V 36 - )
- 4** Ø 40 mm
- 5** Ø 46 mm (B 46 - )
- 6** Ø 60 mm (B 60 - )
- 7** Ø 32 mm (V 32 - )

**Type of fastening**

- F** Spring-supported shock absorber / McPherson strut
- S** Pin
- A** Eye
- G** Yoke
- L** Clip
- B** Base piece
- Y** Stub axle
- X** Special version

**Notes**

- 0)** Manufactured to order, not always in stock!
- R)** Repair insert
- 7)** With spherical joints
- 38)** Damping force at 0,26 m/s or 0,39 m/s
- 40)** Thread M10
- 51)** With additional grooves
- 54)** On consignment
- 61)** With 50 mm chrome tube
- 79)** For the vehicles with front struts only
- 81)** Except mounting parts
- 129)** Incl. thread
- 132)** Except Caravan
- 133)** Not EVO
- 134)** Incl. Facelift 1997
- 135)** With damping force adjustment
- 137)** Ø 40
- 138)** Ø 41

**Order instructions**

All orders are accepted subject to our delivery and payment terms. All information is subject to change without prior notice. Reproduction, in whole or in part, is not permitted without consent.

Modell / model	Typ / type	Variante / variant	Hinweis / note	Aufbauart / body	2WD	4WD	Baujahr / year	Vorderachse/ front axle			Hinterachse/ rear axle		
								Material-No.	Aufh. / mounting	Hinweis / note	Material-No.	Aufh. / mounting	Hinweis / note

### ALFA ROMEO

Alfa 156	932	Rennen/ Race Gruppe N					09.97-	K4-BE5-60489T0		(400/ 150) , 129) , 0)	F4-VE3-4370-T0		(300/ 150) , 129) , 0)
----------	-----	-----------------------	--	--	--	--	--------	----------------	--	------------------------	----------------	--	------------------------

### BMW

1502 -2002 Ti		Rennen /Race Gr. I u. II					01.71-07.75	K4-VE3-63379M0	F S X	(220/ 120) , 0)	24-604277	S A	(180/ 120) , 0)
1502 -2002 Ti		Rennen /Race Gr. I u. II					01.71-07.75	K4-VE3-61826M0	F S X	(300/ 120) , 129) , 0)	24-604277	S A	(180/ 120) , 0)
2.8 - 3.0 CS/ CSI		Rennen/ Race Gr. I u. II		Coupé			68-08.76				K4-BE5-61413M0	S A	(300/ 120) , 0)
3er- Reihe	E30	Rennen / Race Gruppe N					09.82-06.91	34-046296	S B	(300/ 300) , 0)	24-000642	S A	(200/ 200) , 0)
3er- Reihe	E30	Rennen / Race Gruppe N					09.82-06.91	K4-VE3-60922M0	F S X , original spindle required	(300/ 300) , 129) , 0)	24-000642	S A	(200/ 200) , 0)
3er- Reihe	E30	Rennen /Race 325 Cup					09.82-06.91	K4-PE3-63459T0	S B	(300/ 300) , 0)	24-000642	S A	(200/ 200) , 0)
3er- Reihe	E30	Rallye					09.82-06.91	34-236406	S B	(280/150) , 0)	24-233637	S A	(260/120) , 0)
M3	E254	Rennen/ Race Gruppe N					87-89	34-046296	S B	(300/ 300) , 0)	24-000642	S A	(200/ 200) , 0)
M3	E254	Rennen/ Race Gruppe N					87-89	K4-VE3-61915M0	F S X , original spindle required	(300/ 300) , 0)	24-000642	S A	(200/ 200) , 0)
3er- Reihe/ M3	E36	Rennen/ Race Gruppe N 316i, 318i, 320i, 323i, 325i, 328i, M3					91-5.92	K4-VE3-64173M0 L K4-VE3-64175M0 R	F S X	(300/ 300) , 129) , 0)	K4-BE3-05551T9	S A	(200/ 200) , 0) Standard (250/ 280) , 0) (210/ 240) , 0)
3er- Reihe/ M3	E36	Rennen/ Race Gruppe N 316i, 318i, 320i, 323i, 325i, 328i, M3					91-5.92	K4-XDE-64172M0	F S X	(300/ 300) , 129) , 0)	K4-BE3-05551T9	S A	(200/ 200) , 0) Standard (250/ 280) , 0) (210/ 240) , 0)
3er- Reihe/ M3	E36	Rennen/ Race Gruppe N 316i, 318i, 320i, 323i, 325i, 328i, M3					91-5.92	K4-XDE-05778T9	F S X	(250/ 250) , 129) , 0) (300/ 200) , 129) , 0) (350/ 300) , 129) , 0) (350/ 200) , 129) , 0)	K4-BE3-05551T9	S A	(200/ 200) , 0) Standard (250/ 280) , 0) (210/ 240) , 0)
3er- Reihe/ M3	E36	Außenteil/ strut housing					91-5.92	K4-XRA-61172M0 L K4-XRA-61173M0 R		129) , 81) , 0) anti-roll bar bracket: series height			
3er- Reihe/ M3	E36	Außenteil/ strut housing					91-5.92	K4-XRA-63192M0 L K4-XRA-63193M0 R		129) , 81) , 0) anti-roll bar bracket: for Nordschleife			
3er- Reihe	E36	Rennen/ Race Gruppe N 320i, 323i, 325i	PSS9 front left				91-5.92	31-602068	F S X	left, 129) , 135) anti-roll bar bracket: series height	26-602059	S A	129) , 135) not for original top mount
3er- Reihe	E36	Rennen/ Race Gruppe N 320i, 323i, 325i	PSS9 front right				91-5.92	31-602075	F S X	right, 129) , 135) anti-roll bar bracket: series height	26-602059	S A	129) , 135) not for original top mount
3er- Reihe	E36	Außenteil/ strut housing	135)				91-5.92	K4-XRA-63392M0 L K4-XRA-63393M0 R		129) , 81) , 0) anti-roll bar bracket: for Nordschleife	26-602059	S A	129) , 135) , 0) not for original top mount
3er- Reihe/ M3	E36	Rallye		Lim/ Cpe				35-233596 L 35-233602 R	S B	(280/ 150) , 0)	24-233613	S A	(260/ 120) , 0)
3er- Reihe/ M3	E36	Rallye		Compact				on request	S B	(280/ 150) , 0)	on request	S A	(260/ 120) , 0)
Formel Junior		Rennen/ Race					- 01	K4-BE5-60808T0	A A	0)	K4-BE5-60807T0	A A	0)

### CATERHAM

Super Seven		Rennen/ Race						F4-B46-1899-M0	F A A	129) , 0)	F4-B46-1900-M0	F A A	129) , 0)
-------------	--	--------------	--	--	--	--	--	----------------	-------	-----------	----------------	-------	-----------

### CITROEN

AX GTI		Gruppe N							F S Y	Quick repair service; used part return required	F4-BE5-6021-M0	A A	(260/179) , 0) , 7) , 38)
AX / Saxo	ZA_	Rallye Asphalt/ Tarmac Gruppe N					86-04	F4-P30-0351-H1	S B	(351/ 160) , 0)	24-012768	A A	0)

Modell / model	Typ / type	Variante / variant	Hinweis / note	Aufbauart / body	2WD	4WD	Baujahr / year	Vorderachse/ front axle			Hinterachse/ rear axle		
								Material-No.	Aufh. / mounting	Hinweis / note	Material-No.	Aufh. / mounting	Hinweis / note
Saxo	S8 Cup	Rennen/ Race Cup					96-	K4-VE3-06084T0 L K4-VE3-06085T0 R		Quick repair service; used part return required	F4-BE5-2648-M2	A A	(860/ 240) , 0) , 7)
Saxo	S8 Cup	Rennen/ Race Cup						F4-XDE-7830-M0 Innenteil/ insert		(200/ 138) , 0)	F4-BE5-2648-M2	A A	(860/ 240) , 0) , 7)
Saxo Challenge		Rennen/ Race									F4-BE5-2515-M2	A A	(6070/2565), 38), 0) , 7)
<b>FIAT</b>													
Cinquecento		Rallye Tarmac Cup Gruppe N						K4-VE3-05634T0	F S L	Quick repair service; used part return required			
Cinquecento		Rallye Gravel Cup Gruppe N						K4-VE3-05634T0	F S L	Quick repair service; used part return required			
Cinquecento		Cup/ Trofeo						K4-XDE-05634T9 Innenteil/ insert	S B	(400/ 150) , 0)	K4-BE3-05633T1	A A	(380/ 150) , 0)
Cinquecento		Cup						K4-XDE-05634T9 Innenteil/ insert	S B	(300/ 120) , 0)	K4-BE3-05633T9	A A	(280/ 80) , 0)
Cinquecento		Cup						K4-XDE-05634T9 Innenteil/ insert	S B	(320/ 140) , 0)	K4-BE3-05633T0	A A	(300/ 100) , 0)
Punto Kit Car		Rallye Gravel						K4-VE3-61827M9	F S L	Quick repair service; used part return required			
Punto Kit Car		Rallye Gravel						K4-XDE-61827M9 Innenteil/ insert		(300/ 150) , 0)	K4-BE5-61828M9	A A	(350/ 250) , 0) , 129)
Punto Kit Car		Rallye Asphalt/ Tarmac						K4-VE3-61709M9	F S L	Quick repair service; used part return required			
Punto Kit Car		Rallye Asphalt/ Tarmac	137)					K4-XDE-61962M9 Innenteil/ insert		(300/ 200) , 0)	K4-BE5-61711M9	A A	(350/ 250) , 0) , 129)
Punto		Rennen Gruppe N						F4-VE3-5178-M0	F S L	Quick repair service; used part return required	K4-BE3-61921M0	A A	(500/ 180) , 0)
Punto		Rallye Gruppe N									K4-BE5-62290M0	A A	(500/ 200) , 0)
Seicento		Rallye						K4-VE3-05634T0	F S L	Quick repair service; used part return required	K4-BE3-05633T1	A A	(380/ 150) , 0)
Seicento		Rallye									K4-BE3-05633T9	A A	(280/ 80) , 0)
Seicento		Rallye									K4-BE3-05633T0	A A	(300/ 100) , 0)
<b>FORD</b>													
Escort RS 1600, RS 2000		Rallye Asphalt Gruppe 4	only for Rallyecar				68-74				24-021906 (F4-B46-2190-H2)	F S A	(220/ 110) , 7) , 129) , 0) ext/comp: 531/325
Escort II, RS 1600, RS 2000		Rallye Gravel Gruppe 4	only for Rallyecar				74-80				24-007672 (F4-B46-0767-H2)	S A	(230/110) , 0) ext/comp: 516/372
Escort II, RS 1600, RS 2000		Rallye					74-80	F4-XDE-G778-T0 Innenteil/ insert	F S X	(260/60), 0) ext/comp: 551/413	24-008716	S A	(180/90), 0) ext/comp: 474/297
Escort II, RS 1600, RS 2000		Rallye					74-80	F4-XDE-G778-T1 Innenteil/ insert	F S X	(300/70), 0) ext/comp: 551/413	24-008716	S A	(180/90), 0) ext/comp: 474/297
Escort II, RS 1600, RS 2000		Rallye					74-80	F4-XDE-G778-T2 Innenteil/ insert	F S X	(300/100), 0) ext/comp: 551/413	24-008716	S A	(180/90), 0) ext/comp: 474/297
Escort II, RS 1600, RS 2000		Rallye					74-80	F4-R36-5041-H1 Innenteil/ insert	F S X	(300/70), 0) , Cortina pin ext/comp: 500/388	24-008716	S A	(180/90), 0) ext/comp: 474/297
Escort RS 2000		Cup			2			K4-VE3-59444T0	S X	(330/ 270) , 129) , 0)	K4-BE5-60804T0	S A	(270/ 160) , 51) , 0)
Escort und Sierra Cosworth		Rennen/ Race Gruppe N				4		K4-VE3-05596T9	F S X	(320/ 250) , 129) , 0)	24-044578	A A	(275/160) , 0)
Escort und Sierra Cosworth		Rallye Tarmac Gruppe N				4		K4-VE3-05271M9	F S X	(325/ 150) , 129) , 0)	24-044578	A A	(275/160) , 0)
Escort und Sierra Cosworth		Rallye Gravel Gruppe N				4		K4-VE3-05220M9	F S X	(360/ 140) , 129) , 0)	K4-BE3-61830M0	A A	(230/ 125) , 0) ext/comp: 629/398
Escort Cosworth		Rallye Gravel Gruppe A					92-				24-024884	S A	(350/ 130) , 7) , 129) , 0)

Modell / model	Typ / type	Variante / variant	Hinweis / note	Aufbauart / body	2WD	4WD	Baujahr / year	Vorderachse/ front axle			Hinterachse/ rear axle		
								Material-No.	Aufh. / mounting	Hinweis / note	Material-No.	Aufh. / mounting	Hinweis / note
Escort Cosworth		Rallye Gravel Gruppe A					92-				24-021890	S A	(350/ 130), 7), 129), 0) Aluminium
Fiesta XR2i		Cup					90-92	K4-V36-52509H0		0)	K4-B46-52510H0		0)
Puma		Rennen/ Race Cup					97-8/98	35-043898 (F4-VE3-4389-M0)	F S X	(230/ 100), 129), 0)	24-027113	S G	(200/ 125), 129), 0)
Puma		Rennen/ Race Cup					9/98-	35-043898 (F4-VE3-4389-M0)	F S X	(230/ 100), 129), 0)	F4-BE5-9018-S0	S G	(200/ 125), 129), 0)
Sierra Cosworth		Rennen/ Race Gruppe N	RWD			2		K4-VE3-61323M0	F S X	(320/ 250), 129), 0)	24-044578	A A	(275/160), 0)
Sierra Cosworth		Rallye Gruppe N	RWD			2		K4-VE3-62305M0	F S X	(300/ 125), 129), 0)	K4-BE3-61830M0	A A	(230/ 125), 0)
Sierra Cosworth		Rallye Gravel Gruppe A				4	90-92				24-024884	S A	(350/ 130), 7), 129), 0)
Sierra Cosworth		Rallye Gravel Gruppe A				4	90-92				24-021890	S A	(350/ 130), 7), 129), 0) Aluminium
<b>ISUZU</b>													
Gemini 1600	PF50, PF60, incl. ZZR, ZYT	Rallye					6.75-85	24-008839	S A	0)	F4-B46-0918-H0	S A	0)
<b>LADA</b>													
Nova, Riva		Rallye Gruppe N					72-90	24-004473	S A	0)	F4-B46-0457-H1	A A	0)
<b>LANCIA</b>													
Delta EVO / HF	831	Rallye Gruppe A						K4-XDE-04564T0 Innenteil/ insert		61), 0)	K4-XDE-04568T0 Innenteil/ insert		61), 0)
Delta	831	Rallye Gruppe N	not EVO					MSP-04423		Quick repair service; used part return required	MSP-04424		Quick repair service; used part return required
Delta	831	Rallye Gruppe N	not EVO					MSP-04767		129) Quick repair service; used part return required	MSP-04768		129) Quick repair service; used part return required
Stratos		Monte Carlo (Rallye Tarmac)						K4-BE5-59352H0	A A	(170/ 55), 0)	K4-PE3-60174T0	S B	(250/ 120), 0)
<b>MERCEDES BENZ</b>													
MB	W123	Rallye 200-280E, 200D-300D, 230CE					01.76-12.85	24-005289	S A	(262/113), 0) ext/comp: 463/300	24-005388	S A	(544/227), 0) ext/comp: 436/276
<b>NISSAN</b>													
Micra Challenge	K11	Rallye					93-03	F4-XDE-7800-M0 Innenteil/ insert		(315/ 150), 0)	F4-B46-2210-M0		(230/83), 0)
<b>OPEL</b>													
Ascona	B	Rennen/ Race					10.75-81	24-000819	S A	(311/160), 0)	24-000918	S A	(274/95), 0)
Ascona	B	Rallye					10.75-81	24-008839	S A	(260/110), 0)	24-008938	S A	(220/78), 0)
Astra	F	Rallye				X	91-98	on request	cartridge	umstellen	24-024846	S A	(210/ 090), 7), 0)
Astra	G	Rallye Asphalt				X	98-05	on request	cartridge	270/120	on request	AA	180/125
Corsa / Tigra	A/ B	Rallye Gruppe N+G					83-00	35-041757	F S L	(230/ 80), 0) ext/comp 455/356	F4-BE3-2391-H0	S A	(200/ 80), 0) ext/comp 445/277
Corsa / Tigra	A/ B	Rennen/ Race Gruppe N+G	incl facelift 1997				83-00	35-042136	F S L	(230/ 80), 0) ext/comp 432/356	24-023900	S A	(200/ 80), 0) ext/comp 430/271
Kadett	C GTE	Rallye Gruppe N	not City (rear)				73-79	24-009089	S A	(270/140), 0) ext/comp: 383/256	24-009188	S A	(195/58), 0) ext/comp: 577/356
Kadett	C	Rennen/ Race Gruppe N	not City (rear)				73-79	24-633369	S A	(320/ 160), 0) ext/comp: 381/257	24-633376	S A	(195/90), 0) ext/comp: 577/356
Kadett	D/ E	Rallye Cup					79-91	34-001462	S B	(250/ 080), 79), 0)	24-000925	S A	(160/ 050), 7), 0)
Kadett	D/ E	Rallye					79-91	34-030721	S B	(270/ 120), 79), 0)	24-024846	S A	(210/ 090), 7), 0)
Kadett	D/ E	Rallye					79-91	F4-PE3-3081-T1	S B	(290/ 120), 79), 0)	F4-BE5-2370-T0	S A	(220/ 120), 7), 0)

Modell / model	Typ / type	Variante / variant	Hinweis / note	Aufbauart / body	2WD	4WD	Baujahr / year	Vorderachse/ front axle			Hinterachse/ rear axle		
								Material-No.	Aufh. / mounting	Hinweis / note	Material-No.	Aufh. / mounting	Hinweis / note
Kadett	D/ E	Rallye Asphalt Gruppe N+G Rennen/ Race					79-91	34-236437	S B	(310/ 140) , 79) , 0)	24-024877	S A	(240/ 140) , 7) , 0)
Manta	B	Rennen/ Race					10.75-88	F4-B46-0081-H0	S A	0)	24-000918	S A	0)
Manta	B	Rallye					10.75-88	F4-B46-0883-H0	S A	0)	F4-B46-0893-H0	S A	0)
<b>PEUGEOT</b>													
106	I/ II	Rallye Gruppe N					91-	VE3-60809 L VE3-60809 R	S Y	(250/ 120) , 0) Quick repair service; used part return required			
106	I/ II	Rallye Gruppe N					91-	K4-XDE-60809T0 Innenteil/ insert		(250/ 120) , 0)	F4-B46-2220-T1	A A	(460/ 250) , 38) , 0)
106	I/ II	Rallye Gruppe N					91-	34-003510	S B	(350/ 160) , 0)	24-012768	A A	(476/ 277) , 38) , 0)
205	741A, C	Rennen/ Race Gruppe N					02.83-10.87	35-005476 R 35-005483 L	F S L	(260/ 120) , 0)	24-010382	A A	(248/157) ,38),0)
205	741A, C	Rennen/ Race Gruppe A					02.83-10.87	35-623816 R 35-623809 L	F S L	(300/140) , 129) , 0)	24-023139	A A	(350/200) ,38) ,0)
205	741A, C	Rallye Gruppe N					02.83-10.87	35-005476 R 35-005483 L	F S L	(260/ 120) , 0)	24-010382	A A	(248/157) ,38),0)
309	10C, 10A	Rennen/ Race Gruppe N					10.85-12.89	35-005476 R 35-005483 L	F S L	(260/ 120) , 0)	F4-B46-1038-H2	A A	(248/157) ,38),0)
309	10C, 10A	Rennen/ Race Gruppe A					10.85-12.89	35-623816 R 35-623809 L	F S L	(300/140) , 129) , 0)	24-023139	A A	(350/200) ,38) , 0)
309	10C, 10A	Rallye Gruppe N					10.85-12.89	35-005476 R 35-005483 L	F S L	(260/ 120) , 0)	F4-B46-1038-H2	A A	(248/157) ,38),0)
<b>PORSCHE</b>													
356		Rennen/ Race						K4-BE5-59995T0	A A	(205/ 62) , 0)	K4-BE5-59996T0	S A	(258/ 98) , 0)
911 Carrera, 930 Turbo, RSR		Rennen/ Race					72-90	K4-V36-58774H0 L K4-V36-58773H0 R	F S Y	(160/160) , 129)	24-595452	F S A	(180/170) , 129)
911 Carrera, 930 Turbo, RSR		Rennen/ Race					72-90				K4-BE5-61732M9	F S A	(220/ 180) , 0) , 129)
911 Carrera, 930 Turbo, RSR		Rennen/ Race					72-90	F4-RE3-H772-H0 Innenteil/ insert		(160/ 160) , 0)	24-009676	S A	(200/ 190) , 0)
911 Carrera, 930 Turbo, RSR		Rennen/ Race					72-90	F4-RE3-5049-H2 Innenteil/ insert		(200/ 170) , 0)			
911 Carrera, 930 Turbo, RSR		Rallye Asphalt/ Tarmac	Monte Carlo				72-90	K4-P36-51138H0 Innenteil/ insert		(220/ 50) , 0)	F4-B46-0180-H0	S A	(325/89) , 0)
911 Carrera, 930 Turbo, RSR		Rallye Gravel	1000-Seen				72-90	K4-RE3-61220M0 Innenteil/ insert		(270/ 100) , 0)	F4-B46-0973-H1	S A	(325/150) , 0)
964 Cup		Rennen/ Race						K4-V36-59118H0 L K4-V36-59117H0 R	F S L	(220/ 70) , 0) , 129)	K4-BE5-04887T0	F S A	(380/ 170) , 0) , 129)
964 RSR	3,8l	Rennen/ Race						K4-VE3-05767TL K4-VE3-05767TR	F S L	(237/ 96) , 0) , 129)	K4-BE5-05760T1	F S A	(400/ 220) , 0) , 129)
964 RSR	3,8l	Rennen/ Race						K4-XDE-05767T0 Innenteil/ insert		(237/ 96) , 0)			
993	GT 2	Rennen/ Race					2	K4-VR3-05927TL K4-VR3-05927TR	F S L	0) , 129) , 135)	K4-BR5-05928TL K4-BR5-05928TR	F S A	0) , 129) , 135)
993	GT 2	Rennen/ Race Nürburgring					2	K4-VR3-62047M0 L K4-VR3-62046M0 R	F S L	0) , 129) , 135)	K4-BR5-62048M0 L K4-BR5-62049M0 R	F S A	0) , 129) , 135)
993 Super Cup '95		Rennen/ Race					9.-95	K4-VE3-05816TL K4-VE3-05816TR	F S L	(110/ 60) , 38) , 0) , 129)	F4-BE5-2353-T3	F S A	(290/ 190) , 38) , 0) , 129)
993 Super Cup '96		Rennen/ Race					96-	K4-VE3-06077T0 L K4-VE3-06078T0 R	F S L	(270/110) , 0) , 129)	F4-BE5-2353-T2	F S A	(300/ 200) , 38) , 0) , 129)
996 GT3 Cup		Rennen/ Race Cup					ab 98	34-610848	F S B	(185/ 99) , 38) , 0) , 129)	24-025409	F S A	(325/ 246) , 38) , 0) , 129)
996 GT3R		Rennen/ Race					ab 98	F4-VR3-4601-T0	F S X	0) , 129) , 135)	F4-BR5-2973-T0	F S A	0) , 129) , 135)
996 GT3/ GT2	Straße/ Street	Clubsport 1-Wege		Coupe	2		ab 98	K4-VM3-63011M0	F S X	129) , 135)	K4-BM5-62464M0	F S A	129) , 135)
944 Cup		Rennen/ Race Cup					87-89	35-593744 L 35-593751 R	F S L	(600/190) , 129)	24-176422	F A A	(565/218) , 129)

Modell / model	Typ / type	Variante / variant	Hinweis / note	Aufbauart / body	2WD	4WD	Baujahr / year	Vorderachse/ front axle			Hinterachse/ rear axle		
								Material-No.	Aufh. / mounting	Hinweis / note	Material-No.	Aufh. / mounting	Hinweis / note

### RENAULT

Campus	Formel	Rennen/ Race						F4-BE5-2456-T0	F A A	7) , 129) , 0)	F4-BE5-2456-T0	F A A	7) , 129) , 0)
Clio Cup '96	Clio I	Rennen/ Race					90-98	F4-VE3-4162-T0 L F4-VE3-4163-T0 R	F S L	(359/250) , 0)	F4-B46-2221-T0	A A	(533/380) , 7) , 0)
Megane Cup '97		Rennen/ Race						F4-VE3-4257-M0	F S L	(230/430) , 0) , 129)	F4-BE5-2454-T0	F A A	7) , 0) , 129)
Megane Cup '97		Rennen/ Race						F4-XDE-7816-M0 Innenteil/ insert		0)			
R 405 R5 GT Turbo	Phase I	Rallye Gruppe N					5.84- 6.87				24-009942	A A	(408/219) , 0)
R 405 R5 GT Turbo	Phase II	Rallye Gruppe N					7.87- 90				24-009942	A A	(408/219) , 0)
5	122	Rallye Gruppe N					72-85				24-009942	A A	(408/219) , 0)
Super 5	B/C 40	Rallye Gruppe N					84-96				24-009942	A A	(408/219) , 0)
R 5 Alpine/ Turbo		Rallye					-4.84	F4-B46-0981-H0	S A	(420/287) , 0)	F4-B46-0991-H0	S A	(317/146) , 0)
R 5 Alpine/ Turbo		Rennen/ Race Cup					-4.84	24-009805	S A	(380/240) , 0)	F4-B46-0990-W1	S A	(275/98) , 0)
Sport Spider Cup		Rennen/ Race Cup						F4-B46-2160-M1	F S A	(180/100) , 7) , 129) , 0)	F4-B46-2161-M1	F S A	(600/330) , 7) , 129) , 0)

### SAAB

99 GL		Rallye					68- 7.78	F4-B46-2293-H1	A A	(375/150) , 38) , 0)			
99 incl. Turbo		Rallye					8.78- 84	F4-B46-2293-H1	A A	(375/150) , 38) , 0)	F4-B46-2294-H0	S A	0)
900 I incl. Turbo		Rallye					78- 6.93				F4-B46-2294-H0	S A	0)

### SEAT

Ibiza	6K1	Rallye Cup Spanien Asphalt		Schrägheck/ Hatchback	2		93-99	K4-VE3-60209-T0	F S L	(220/ 200) , 129) , 0)	K4-BE5-60215T0	F S A	(160/ 650) , 129) , 0)
Ibiza	6K1	Rallye Cup Deutschland Gravel/ Asphalt		Schrägheck/ Hatchback	2		93-99	K4-VE3-60830T0	F S L	(220/ 200) , 129) , 0)	K4-BE5-60215T0	F S A	(160/ 650) , 129) , 0)
Ibiza	6K1	Rallye Asphalt/ Tarmac		Schrägheck/ Hatchback	2		93-99	F4-VE3-4160-T0	F S L	(250/ 150) , 0)			
Ibiza	6K1	Rallye Gruppe N Gravel		Schrägheck/ Hatchback	2		93-99	F4-VE3-4159-T0	F S L	(273/ 120) , 0)	B46-58896	F S A	(220/ 700) , 51) , 0)

### TOYOTA

Celica	TE 70, 71, CE 70	Rallye					6.79- 5.85				F4-B46-0154-H2	S A	0)
Yaris		Rennen/ Race Cup					99-05	F4-VE3-4991-M0	F S L	(200/200) , 129) , 0)	F4-BE5-6421-M0	S A	(260/140) , 7) , 0)

### VAUXHALL

Nova	A / B	Rallye Gruppe N+G					83-00	F4-VE3-4175-T1	F S L	(230/ 80) , 0)	F4-BE3-2391-H0	S A	(200/ 80) , 0)
Nova	A / B	Rennen/ Race Gruppe N+G					83-00,	F4-VE3-4213-H0	F S L	(230/ 80) , 0)	F4-BE3-2390-H0	S A	(200/80) , 0)

### VOLKSWAGEN

Golf / Jetta/ Scirocco	17/16/ 53/ 53B	Rennen/ Race Gruppe N				2		35-000594	F S L	(270/94) , 0) Quick repair service; used part return required	F4-B46-0834-H0	F S A	(200/ 73) , 51) , 0)
Golf / Jetta/ Scirocco	17/16/ 53/ 53B	Rennen/ Race Gruppe N				2		34-184530	S B	(250/73) , 0)	F4-B46-0834-H0	F S A	(200/ 73) , 51) , 0)
Golf / Jetta/ Scirocco	17/16/ 53/ 53B	Rennen/ Race Gruppe A+H+II				2		35-603207	F S L	(230/ 80) , 129) , 0) Quick repair service; used part return required	F4-B46-0653-H0	F S A	(200/ 73) , 7) , 129) , 0)
Golf / Jetta/ Scirocco	17/16/ 53/ 53B	Rallye Gruppe N Tarmac/ Gravel				2		35-000594	F S L	(270/94) , 0) Quick repair service; used part return required	24-006576	F S A	(150/ 45) , 51) , 0)
Golf	II	Rallye Asphalt/ Tarmac Gruppe A	for stock rallye car only	Schräg- heck/ Hatch- back	2		83-92				K4-BE5-6002T0	F A A	(200/ 120) , 51) , 0)

Modell / model	Typ / type	Variante / variant	Hinweis / note	Aufbauart / body	2WD	4WD	Baujahr / year	Vorderachse/ front axle			Hinterachse/ rear axle		
								Material-No.	Aufh. / mounting	Hinweis / note	Material-No.	Aufh. / mounting	Hinweis / note
Golf	II	Rallye Gravel Gruppe A	for stock rallye car only	Schrägheck/ Hatchback	2		83-92				K4-BE5-63154M0	F A A	(220/ 90) , 51) , 0)
Golf	II / III	Rennen / Race Gruppe G		Schrägheck/ Hatchback	2		83-97	K4-VE3-59569T0	F S L	(300/120) , 0)	K4-BE3-59568T0	F S A	(300/100) , 0)
Golf	II / III	Rennen / Race Gruppe N+A		Schrägheck/ Hatchback	2		83-97	F4-VE3-4406-M1	F S L	(300/ 120) , 129) , 0)	F4-BE5-2738-M0	F S A	(300/ 120) , 7) , 129) , 0) ext/comp 554/356
Golf	II / III	Rallye Gruppe N		Schrägheck/ Hatchback	2		83-97	35-001065	F S L	(243/ 93) , 0)	24-006552	F S A	(230/ 90) , 51) , 0)
Golf	II / III	Rallye Gravel Gruppe N+A		Schrägheck/ Hatchback	2		83-97	K4-VE3-04056T9	F S L	(230/ 90) , 129) , 0)	K4-BE5-61515M0	F S A	(220/ 90) , 7) , 51) , 0)
Golf	II / III	Rallye Asphalt/ Tarmac Gruppe N+A		Schrägheck/ Hatchback	2		83-97	35-604525	F S L	(230/ 145) , 129) , 0) ext/comp 470/351	24-627009	F S A	(200/ 120) , 7) , 51) , 0)
Jetta II	19E	Rallye Gruppe N					1.84-91	35-001065	F S L	(243/ 93) , 0)	24-006552	F S A	(230/ 90) , 51) , 0)
New Beetle	9C	Cup		Schrägheck Hatchback	2			K4-VE3-61281M9	F S X	(250/ 250) , 0)	K4-BE5-61315M9	S A	(208/ 73) , 7) , 129) , 0)
Lupo Cup		Rennen /Race Cup		Schrägheck Hatchback	2			35-607885	F S L	(200/200) , 129) , 0)	24-607896	S A	(137/110) , 7) , 0)
<b>VOLVO</b>													
240, 242, 244, 245, 262, 264, 265		Rallye					74-	34-030837	S B	(350/ 150) , 0)	24-022118	A A	(275/ 200) , 0)
<b>WARTBURG</b>													
W353	2- Takt	Rallye						K4-BE3-61810M9	A A	(240/ 65) , 0)	K4-BE3-61811M9	A A	(320/ 55) , 0)
<b>MDS</b>													
<b>ALFA ROMEO</b>													
GTA		Rennen						MDS-0062170	A S		MDS-0062171	S A	
<b>BMW</b>													
Alpina B6	GT 3	Rennen/ Race	2-Wege	Coupe				MDS-0035930	F S B		MDS-0035940	S A	
<b>ASTON MARTIN</b>													
Vantage	N24 h	Rennen/ Race	2-Wege				2009-2011	MDS-0045208	S A		MDS-0045209	A S	
Vantage	GT 4	Rennen/ Race	2-Wege				ab 2012	MDS-0064760	A A		MDS-0064761	A A	
<b>AUDI</b>													
R8 LMS	"GT4"	Rennen/ Race	2-Wege				ab 2008	MDS-0042549	A A		MDS-0042550	A A	
RS4	VLN/ Italien	Rennen/ Race	2-Wege				2007-2009	MDS-0028412	A G		MDS-0028413	A A	
RS4	Italien	Rennen/ Race	2-Wege				2007-2009	MDS-0028412	A G		MDS-0034157	A A	
<b>BMW</b>													
E46	nur ETCC	Rennen/ Race	2-Wege					MDS-0047427	F S B		MDS-0048644	A A	
E46 Z4 E9X	außer ETCC	Rennen/ Race	2-Wege					MDS-0041687	F S B		MDS-0048644	A A	
E46 Z4	VLN	Rennen/ Race, ohne Feder / mit Feder für ETCC E46	2-Wege					MDS-0041687	F S B		MDS-0048644	A A	
E9X M3	VLN	Rennen/ Race, ohne Feder	2-Wege					MDS-0035602	F S B		MDS-0035304	A A	
E9X	VLN	Rennen/ Race, ohne Feder	2-Wege					MDS-0041687	F S B		MDS-0046971	S S	
Mini	VLN	Rennen/ Race	2-Wege					MDS-0065247	F S B		MDS-0065248	A S	
M1	VLN	Rennen/ Race	2-Wege					MDS-075340AAA00	A A		MDS-094465AAA00	A A	
E92 M3	GT 4	Rennen/ Race	2-Wege					MDS-0035602	F S B		MDS-130450AAA00	A A	
Z4 M Coupe		Rennen/ Race	2-Wege					MDS-0053354	F S B		MDS-0048644	A A	

Modell / model	Typ / type	Variante / variant	Hinweis / note	Aufbauart / body	2WD	4WD	Baujahr / year	Vorderachse/ front axle			Hinterachse/ rear axle		
								Material-No.	Aufh. / mounting	Hinweis / note	Material-No.	Aufh. / mounting	Hinweis / note
Z4	VLN (SP3)	Rennen/ Race	2-Wege					MDS-0051162	F S B		MDS-0051163	A A	
<b>RENAULT</b>													
Clio	VLN	Rennen/ Race	2-Wege					MDS-0047025	S S		MDS-110430BAA00	A A	
<b>CORVETTE</b>													
C6	"GT 4"	Rennen/ Race, (2-Wege/ 2-Way)	2-Wege					MDS-080350AAA02	A A		MDS-0043220	A G	
C6	"GT 4"	Rennen/ Race, (1-Wege/ 1-Way)						MDS-0041480	A A		MDS-0041481	A G	
C6R	GT 1	Rennen/ Race	2-Wege				bis 2009	MDS-0036439	AA		MDS-0036440	A G	
<b>DALLARA</b>													
F312	Formel 3	Rennen/ Race	2-Wege				ab 2012	MDS-0063330 & Aero-Daempfer MDS-0063331	A A		MDS-0063261 & Aero Dämpfer MDS-0063261	A A	
<b>FERRARI</b>													
F430	GT 2 (VLN)	Rennen/ Race	2-Wege					MDS-0034917	A A		MDS-0034918	A A	
F458	GT 2 LMS	Rennen/ Race	2-Wege					MDS-0055484	A A		MDS-0055485	A A	
F458	GT2 VLN & N24h	Rennen/ Race	2-Wege					MDS-0055486	A A		MDS-0055487	A A	
F458	Challengen	Rennen/ Race	2-Wege					F4-VSE-0071108	A A		F4-VSE-0071109	A A	
F458	GT3	Rennen/ Race	2-Wege					F4-VSE-0075504	A A		F4-VSE-0075505	A A	
<b>FORD</b>													
Focus	CTCC	Rennen/ Race	2-Wege					MDS-0060904	F S B		MDS-120540AAA00	A A	
GT	GT3	Rennen/ Race	2-Wege					MDS-0034907			MDS-0034908		
<b>FORMULA</b>													
STUDENT		Rennen/ Race	2-Wege					MDS-0044118	A A		MDS-0044118	A A	
<b>MERCEDES</b>													
HWA SLS	GT 3 / VLN	Rennen/ Race	2-Wege					MDS-072388AAA01	A A		MDS-109547AAA00	A A	
<b>HYUNDAI</b>													
Genesis	VLN & N24h	Rennen/ Race	2-Wege	Coupe			2011	MDS-0053737	F S B		MDS-120440AAA00	A A	
<b>KTM</b>													
X-Bow		Rennen/ Race	2-Wege					MDS-087440BAA00	A A		MDS-0053249	A A	
<b>LOTUS</b>													
Elise/ Exige Mk2 Toyota	Tuner GP	Rennen/ Race	2-Wege					MDS-088349BAA00	A A		MDS-115426BAA00	A A	
<b>MC LAREN</b>													
MP4-12C	GT 3 / GrandAM	Rennen/ Race	2-Wege				ab 2011	MDS-0063612	A A		MDS-0063621	A A	
<b>NISSAN</b>													
370Z	GT 4 (VLN)	Rennen/ Race	2-Wege					MDS-099498AAA00	A A		MDS-0042631	A G	
GTR	GTR Cup	Rennen/ Race, Stahl Loesung mit Gabel	2-Wege					MDS-0044461 (links/left) & MDS-0044462 (rechts/right)	S G		MDS-0044463	S G	
<b>OSELLA</b>													
PA 20S	Bergmeister.	Rennen/ Race	2-Wege					MDS-050285BAB01	A A		MDS-040275BAB00	A A	
PA 20S		Rennen/ Race	2-Wege					MDS-0030798	A A		MDS-0030798	A A	
PA 20S		Rennen/ Race	2-Wege					MDS-050285BAB00	A A		MDS-050285BAB00	A A	
PA 3		Rennen/ Race	2-Wege					MDS-0063673	A A		MDS-0063674	A A	
<b>PORSCHE</b>													
930 Turbo		Rennen/ Race	2-Wege								MDS-0065232	A A	

Modell / model	Typ / type	Variante / variant	Hinweis / note	Aufbauart / body	2WD	4WD	Baujahr / year	Vorderachse/ front axle			Hinterachse/ rear axle		
								Material-No.	Aufh. / mounting	Hinweis / note	Material-No.	Aufh. / mounting	Hinweis / note
935		Rennen/ Race	2-Wege								MDS-0044369	A A	
962		Rennen/ Race	2-Wege					MDS-048278AAA00	A A		MDS-060310AAA00	A A	
991	Cup	Rennen/ Race	2-Wege				ab 2013	F4-VSE-0068403	F S B		F4-VSE-0068405	S A	
997	GrandAm	Rennen/ Race	2-Wege				2010	MDS-0052794	F S B		MDS-0052817	S A	
997	GrandAm	Rennen/ Race	2-Wege				2012	MDS-0052794	F S B		MDS-0062307	S A	
997	GrandAm	Rennen/ Race	2-Wege				2007	MDS-0035751			MDS-0040900	S A	
997	GT 4	Rennen/ Race	2-Wege					MDS-0035751	F S B		MDS-0042584	S G	
RSR/ Cup/ Cup S/ GT3 R	GP	Rennen/ Race, Stahl Rohr, GP Laenge	2-Wege				RSR bis08/ Cup bis 09	MDS-0040896	F S B		MDS-0046929	S A	
RSR/ Cup/ Cup S/ GT3 R	GP	Rennen/ Race, Alu Rohr, GP Laenge	2-Wege				RSR bis08/ Cup bis 09	MDS-0046192	F S B		MDS-0046929	S A	
997 GT3 R	GP	Rennen/ Race, Stahl Rohr, GP Laenge	2-Wege				ab 2010	MDS-0040896	F S B		MDS-0046929	S A	
997 GT3 R	GP	Rennen/ Race, Alu Rohr, GP Laenge	2-Wege				ab 2010	MDS-0046192	F S B		MDS-0046929	S A	
RSR	GP	Rennen/ Race, GP Laenge	2-Wege				09 bis 11	MDS-0046192	F S B		MDS-0042364	S A	
997 Cup/ Cup S	VLN	Rennen/ Race, Stahl Rohr, VLN Laenge	2-Wege					MDS-0035751	F S B		MDS-0035650	S A	
997 Cup/ Cup S	VLN	Rennen/ Race, Alu Rohr, VLN Laenge	2-Wege					MDS-0045510	F S B		MDS-0035650	S A	
997 GT3 R	VLN	Rennen/ Race, Alu Rohr, VLN Laenge	2-Wege					MDS-0045510	F S B		MDS-0046929	S A	
<b>SEAT</b>													
Leon	Cup	Rennen/ Race	2-Wege					MDS-0042556	F S B		MDS-112473AAA00	A A	
Leon	Cup	Rennen/ Race, HA ohne Feder	2-Wege								MDS-100450AAA00	A A	
<b>WESTFIELD</b>													
S8		Rennen/ Race	2-Wege					MDS-065312BAC00	A A		MDS-080351BAC00	A A	
<b>SPECIAL PARTS – BILSTEIN</b>													
AIRJACK	Short version	ALUMINIUM						14-000669 (F4-BE5-C745-M1)					
AIRJACK	Long version	ALUMINIUM						14-000652 (F4-BE5-C746-M1)					
AIRJACK	Porsche	ALUMINIUM						F4-BE5-A583-T2					

# Notes and explanations.

In cases of doubt please contact your local BILSTEIN dealer or our sales department before conversion.

BILSTEIN shock absorbers must always be replaced in pairs. The conversion requires special tools and expert knowledge. Therefore, converting your vehicle to BILSTEIN must be carried out by a specialist workshop. Use a chassis hoist for the fitting so that the raised vehicle cannot slip. If a chassis hoist is not available, you must ensure that the vehicle is blocked against any movement when it is raised. Under no circumstances should any work be completed underneath the vehicle if it is not adequately secured. Otherwise, there is a risk of extremely serious head injuries and contusions.

The application must be in accordance with the BILSTEIN type list, otherwise the proper function of the BILSTEIN gas pressure shock absorber is no longer guaranteed. The same goes for clamping a shock absorber in a vice or any similar tool.

Under no circumstances may this BILSTEIN gas pressure shock absorber be modified in any way, otherwise all warranty claims and the type homologation will be rendered invalid. The oil fill in a BILSTEIN gas pressure shock absorber is pretensioned with gas.

Opening or heating the shock absorber in contravention of this instruction can result in severe injuries to the hands and face. Do not use impact drivers for unscrewing and tightening the nuts, otherwise the fastening thread will be irreparably damaged.

Self-locking nuts are only allowed to be used once! Suspension springs are pretensioned! For safety reasons, the suspension spring must be pretensioned with the help of an appropriate spring tensioning device. The top mount is only to be removed when the spring is preloaded sufficiently so it can be moved by hand. Severe injuries to the head or upper body may occur if these warnings are disregarded.

All fixing mounts for struts must be tightened before the vehicle is let down to the ground. Ensure that the bump stop and dust cover are correctly and properly fastened.

Re-use any original equipment parts only if they are in good condition, otherwise replace them with new ones. Never remove the thin film of oil on the piston rod and seal. After the conversion, check and/or adjust the track and camber and, if necessary, the brake power control (load-dependent) and ABS sensors according to the manufacturer's data. Also check and adjust the headlight setting if necessary.

Observe the rules specified in the type list when disposing of old parts. If you have any questions about this, please contact our sales department or, for Germany only, PARTSLIFE GmbH.

PARTSLIFE GmbH  
Martin-Behaim-Straße 2  
D-63263 Neu-Isenburg  
Phone + 49 (0) 61 02/8 12 92-0, Fax: -29  
info@partslife.de  
www.partslife.de

## General information BILSTEIN B10 – B16

It is essential to observe the instructions in the expert report and in the installation instructions for chassis before installation. When chassis have a parts report, correct installation of the parts must be confirmed by an expert (TÜV, DEKRA, motor vehicle expert). The specified lowering dimension depends on the engine and equipment of the vehicle, and cannot be guaranteed. The specified lowering data result from the parts report. In the case of threaded suspension systems, the lowest permitted spring collar position must be set for acceptance in accordance with section 19 of the German Road Traffic Regulations. Spring collar positions outside the standard adjustment range must be presented for repeat acceptance by the official body (e.g. TÜV) in accordance with section 21 of the German Road Traffic Regulations. The report must be used as the basis for checking whether, and for which wheel/tyre combinations, it is necessary to have spacer discs.

## Special tool

Special tools are not supplied!

30er cartridge spanner

Order no.: 14-244131

36er cartridge spanner

Order no.: 14-244148

Pro hook wrench DIN 1810 A 68-75

Order no.: Z4-EWK-9923-HO

Pro hook wrench DIN 1810 A 80-90

Order no.: Z4-EWK-9924-HO

## Registering a complaint

The document for registering the complaint can be downloaded from our website at [www.bilstein.com](http://www.bilstein.com)

## Ordering instructions

All orders are accepted subject to our delivery and payment terms. All information is subject to change without prior notice. Reproduction, in whole or in part, is not permitted without consent.



**Disposal of used parts**  
**BILSTEIN gas pressure shock absorbers**

BILSTEIN mono-tube and twin-tube shock absorbers should not simply be thrown away. According to accident prevention and environment regulations, it is absolutely essential to depressurise the shock absorber and properly dispose of its content and its individual parts (danger of explosion when heating over 200 °C). Safety glasses according to DIN standard 58211 part 2 – as used when grinding – are to be worn in accordance with the following disposal procedures.

Disposal:

**Illustrations 1-3:**

BILSTEIN mono-tube gas pressure shock absorbers with a piston rod diameter of 8-14 mm (remove mounting parts, protective tube or dirt shield) are to be fixed on a suitable base, e.g. in a prism and centre marked at the 3 points to be drilled according to drawing no. 1. First of all, holes are to be drilled in the shock absorber close to the shock absorber base (c) with a 5 mm drill bit so that the hydrogen gas (pressure up to 25 bar) can escape. Two holes are now to be drilled at distance (d) in order to enable oil drainage. Proceed in the same manner when dismantling BILSTEIN mono-tube struts according to drawing no. 2. First of all, remove the outer tube. Saw off the tube above the mount (a) (fixture, axle stub, clip) but not the piston rod. Remove burrs from the separated parts. Remove tube by pulling it over the chrome-plated tube. Proceed in the same manner with BILSTEIN cartridge inserts according to drawing no. 3. First of all, remove outer tube. Grip the tube at point (b), turn (stud pointing downwards) and knock heavily against a hard base until the tube falls out of the tube bottom. Remove tube by pulling it over the chrome-plated tube. The details listed in the drawings are to be strictly adhered to.

**Illustration 4:**

BILSTEIN twin-tube gas pressure shock absorbers with a piston rod diameter of 20-24 mm (remove mounting parts, protective tube and dirt shield) are to be fixed on a suitable base, e.g. in a prism and centre marked at the 2 points to be drilled according to drawing no. 4. First of all, drill a hole in the shock absorber close to the piston rod seal with a 5 mm drill bit so that the hydrogen gas can escape (e), then drill a 15 mm deep hole at the point stated (f) (80 mm from bottom of the tube with the piston rod in the extended position) in order to enable oil drainage. By repeated movement of the piston rod the oil is pumped out of the damper tube and collected in an appropriate container. The shock absorber oil, free from PCB and PCT, is to be disposed of in accordance with national waste disposal laws (same regulations apply to motor oil). After the shock absorbers have been depressurised and the oil drained off, shock absorber struts, cartridge inserts and their individual parts – still partly covered with oil and grease – must also be disposed of in accordance with the national waste disposal laws. This information has been provided in good faith, subject to the applicable regulations. We cannot accept liability for each individual circumstance. If in doubt, please contact the Sales Consulting department of ThyssenKrupp Bilstein GmbH or the

PARTSLIFE GmbH  
 Martin-Behaim-Straße 2  
 D-63263 Neu-Isenburg  
 Phone + 49 (0) 61 02/8 12 92-0, Fax: -29  
 info@partslife.de  
 www.partslife.de



1. Fig.

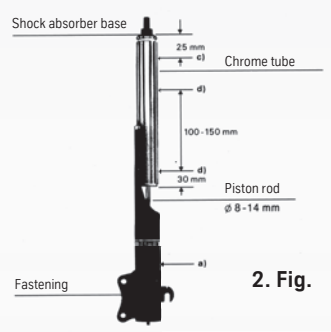

2. Fig.

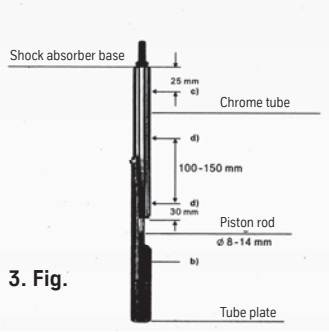

3. Fig.

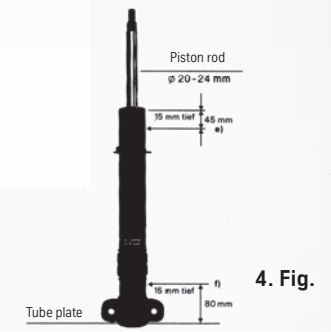

4. Fig.

# Always there for you. Also online.

You will find more detailed information on our products and company at our website [www.bilstein.com](http://www.bilstein.com).

With the **online catalogue**, you have the option of finding the desired product for your vehicle quickly and easily. All

current evaluations are available in PDF format under <http://katalog.bilstein.de>.

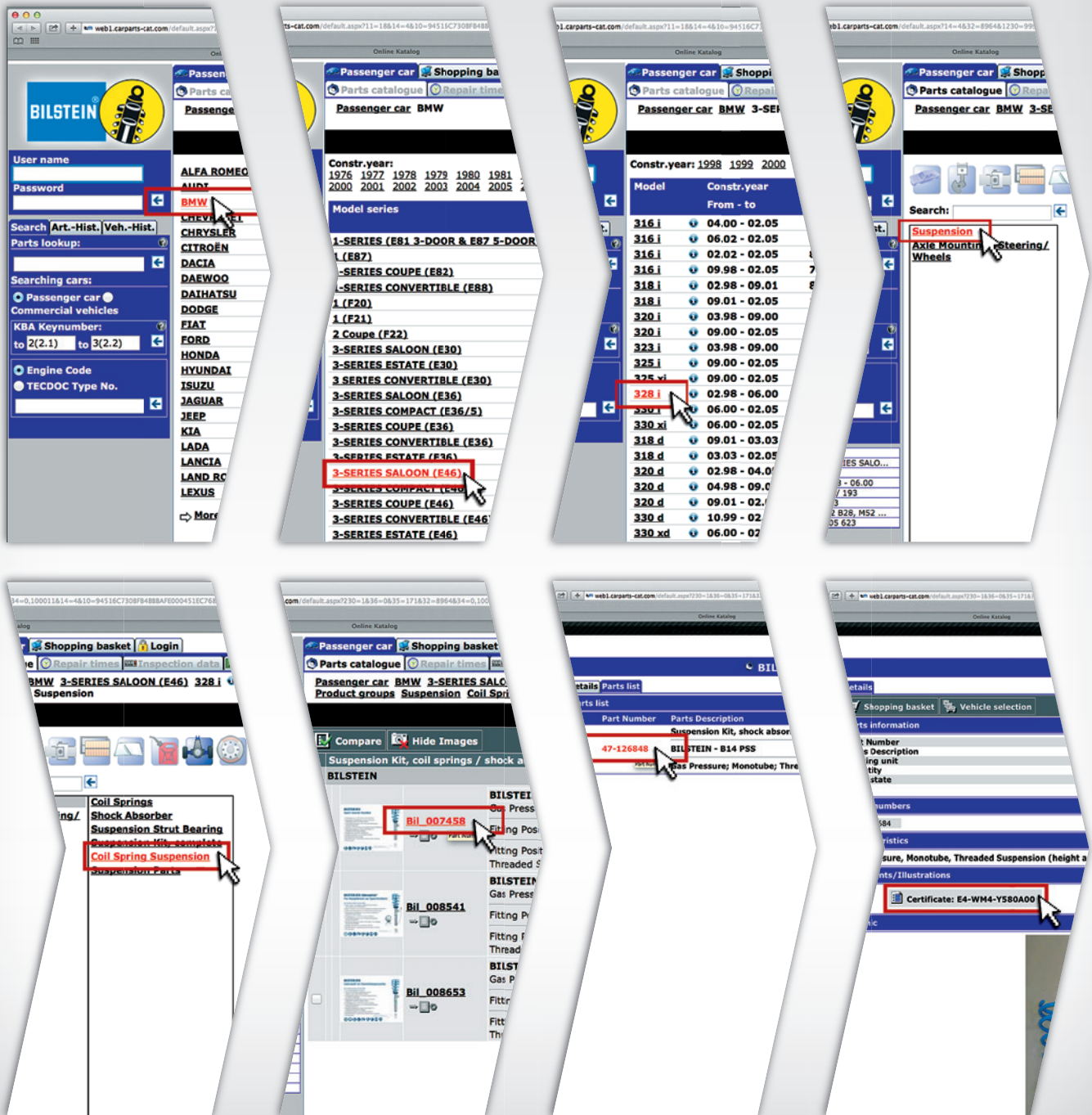

**ThyssenKrupp Bilstein GmbH**

Milsper Straße 214, 58256 Ennepetal, Germany

P.O. Box 1151, 58240 Ennepetal, Germany

☎ +49 2333 791-0

☎ +49 2333 791-4400

✉ info@bilstein.de

www.bilstein.com



08.2014 · W-800741/Subject to technical modifications, misprints and errors excepted.

www.bilstein.com

